

GOT-A900 Series Operating Manual

(GT Works Version5/GT Designer Version5 compatible
Extended•Option Functions Manual)

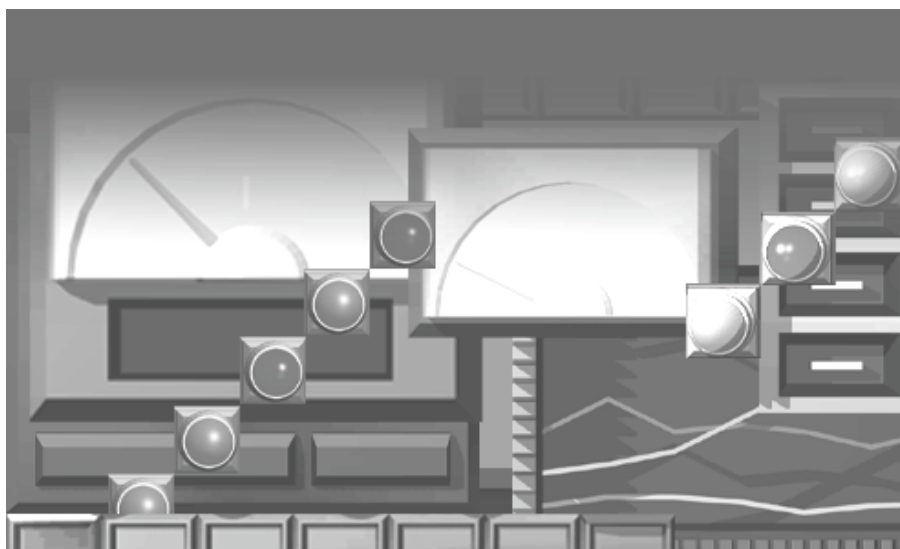

Graphic Operation Terminal
900
series



• SAFETY PRECAUTIONS •

(Always read these instructions before using this equipment.)

Before using this product, please read this manual and the relevant manuals introduced in this manual carefully and pay full attention to safety to handle the product correctly.

The instructions given in this manual are concerned with this product. For the safety instructions of the programmable controller system, please read the CPU module user's manual.

In this manual, the safety instructions are ranked as "DANGER" and "CAUTION".



Indicates that incorrect handling may cause hazardous conditions, resulting in death or severe injury.



Indicates that incorrect handling may cause hazardous conditions, resulting in medium or slight personal injury or physical damage.

Note that the  CAUTION level may lead to a serious consequence according to the circumstances. Always follow the instructions of both levels because they are important to personal safety.

Please save this manual to make it accessible when required and always forward it to the end user.

[PRECAUTION WHEN PERFORMING THE TEST OPERATION]

CAUTION

- Read the manual carefully and fully understand the operation before the test operation (ON/OFF of bit devices, modifying current value of a word device, modifying timer/counter setting, modifying the current value, or modifying the current value of a buffer memory) of system monitor, special function module monitor, and ladder monitor.
In addition, never modify data in a test operation to a device which performs a crucial operation to the system.
It may cause an accident by a false output or malfunction.

REVISIONS

* The manual number is given on the bottom left of the back cover.

Print Date	* Manual Number	Revision
Aug., 2000	SH (NA)-080118-A	First edition
Oct., 2000	SH (NA)-080118-B	Partial additions Section 3.1, Section 3.2, Section 3.3, Section 3.4
Nov., 2000	SH (NA)-080118-C	Partial corrections Section 4.12 Partial additions Section 4.1, Section 4.5
Feb., 2001	SH (NA)-080118-D	Partial additions Chapter 1, Chapter 2, Section 3.1, Section 3.1.1, Section 3.2, Section 3.2.4, Section 3.3, Section 3.4, Section 3.5, Section 3.5.1, Section 3.5.4, Section 4.2, Section 4.3, Section 4.5, Section 6.1.1, Section 17.1.1, Section 17.2.1, Section 17.2.2, Section 17.2.3, Section 17.2.4, Section 17.3.1, Section 17.3.2, Section 17.3.3, Section 17.3.4, Section 17.3.5, Section 17.3.6, Section 17.3.7
May., 2001	SH (NA)-080118-E	Partial additions Section 1.1.2, Section 2.2, Section 2.3, Section 3.1.1, Section 3.4.3, Section 4.3, Section 4.5, Section 4.8, Section 5.2, Section 6.2.1, Section 6.2.4, Section 6.3.1, Section 6.3.5, Chapter 7, Section 9.1.3, Section 9.2.2, Section 9.3.2, Section 9.4.2, Section 9.5.2, Section 9.6.1, Section 12.1.1, Section 12.1.2 Additions Section 6.1
Aug., 2001	SH (NA)-080118-F	Partial additions Section 2.1, Section 2.2, Section 2.3, Section 3.1.1, Section 3.3.3, Section 3.4.3, Section 3.5.1, Section 4.1, Section 4.2, Section 6.2.1, Section 9.1.2, Section 9.1.3, Section 12.3, Section 17.1.1, Section 17.2.3 Additions Section 1.1.7, Section 3.6, Section 3.6.1, Section 3.6.2, Section 3.6.3, Section 3.6.4, Section 12.32, Chapter 22, Chapter 23, Chapter 24
May, 2002	SH (NA)-080118-G	Partial additions Section 1.1.1, Section 2.1, Section 2.2, Section 2.3, Section 3.1.2, Section 3.6.4, Section 4.1, Section 4.2, Section 4.3, Section 4.4, Section 4.5, Section 4.6, Section 4.12, Section 5.2, Section 6.1, Section 6.2.1, Section 6.2.3, Section 6.2.4, Section 6.2.5, Section 6.3.1, Section 6.3.5, Section 9.1.2, Section 23.5 Additions Section 1.1.8, Section 3.7, Chapter 25, Chapter 26, Chapter 27
Jul., 2003	SH (NA)-080118-H	Partial additions Section 2.3
Jun., 2004	SH (NA)-080118-I	Partial corrections Manuals MODEL CODE change Changed from 13JU08 to 1DM185

* The manual number is given on the bottom left of the back cover.

Print Date	* Manual Number	Revision				
Jan., 2006	SH (NA)-080118-J	<table border="1"><tr><td data-bbox="569 329 799 365">Partial corrections</td></tr><tr><td data-bbox="569 371 727 407">Section 9.1.2</td></tr><tr><td data-bbox="569 414 775 450">Partial additions</td></tr><tr><td data-bbox="569 456 727 492">Section 6.3.2</td></tr></table>	Partial corrections	Section 9.1.2	Partial additions	Section 6.3.2
Partial corrections						
Section 9.1.2						
Partial additions						
Section 6.3.2						

Japanese Manual Version SH-080113-K

This manual confers no industrial property rights or any rights of any other kind, nor does it confer any patent licenses. Mitsubishi Electric Corporation cannot be held responsible for any problems involving industrial property rights which may occur as a result of using the contents noted in this manual.

© 2000 MITSUBISHI ELECTRIC CORPORATION

INTRODUCTION

Thank you for choosing the Mitsubishi Graphic Operation Terminal.
Please read this manual carefully so that equipment is used to its optimum.

CONTENTS

SAFETY PRECAUTIONS.....	A - 1
REVISIONS.....	A - 2
INTRODUCTION.....	A - 4
CONTENTS.....	A - 4
About Manuals	A -11
Abbreviations and generic terms in this manual	A -12

1 OVERVIEW	1 - 1 to 1 - 15
-------------------	------------------------

1.1 Features	1 - 1
1.1.1 Features of the utility function	1 - 1
1.1.2 Features of the ladder monitor function	1 - 3
1.1.3 Features of the system monitor function	1 - 5
1.1.4 Features of the special module monitor function	1 - 7
1.1.5 Features of the network monitor function	1 - 9
1.1.6 Features of the List editor function	1 -11
1.1.7 Features of the motion monitor function	1 -12
1.1.8 Features of the servo amplifier monitor functions	1 -14

2 BEFORE BEGINNING OPERATION	2 - 1 to 2 - 7
-------------------------------------	-----------------------

2.1 Before getting started with various functions	2 - 1
2.2 Required equipment.....	2 - 1
2.3 Precautions before use.....	2 - 2

3 SPECIFICATIONS	3 - 1 to 3 -25
-------------------------	-----------------------

3.1 Ladder monitor function specifications	3 - 1
3.1.1 PLC CPUs to be monitored	3 - 1
3.1.2 Access ranges to be monitored	3 - 1
3.2 System monitor function specifications	3 - 2
3.2.1 PLC CPUs to be monitored	3 - 2
3.2.2 Access ranges to be monitored	3 - 2
3.2.3 Names of devices to be monitored	3 - 2
3.2.4 Precautions when using the system monitor function	3 - 2
3.3 Special module monitor function specifications	3 - 4
3.3.1 Access ranges to be monitored	3 - 4
3.3.2 Special function modules to be monitored	3 - 4
3.3.3 Required memory spaces for use of special module monitor function	3 - 5
3.3.4 Precautions when using the special module monitor function	3 - 6
3.4 Network monitor function specifications	3 - 9
3.4.1 Network information to be monitored	3 - 9
3.4.2 Access ranges to be monitored	3 -10
3.4.3 Precautions when using the network monitor function	3 -10
3.5 List editor function specifications	3 -11

3.5.1 PLC CPU that allows for list edit.....	3-11
3.5.2 Access range that allows for list edit	3-11
3.5.3 Precautions for List editor function	3-11
3.5.4 List of key arrangement and key functions.....	3-12
3.5.5 Display format on the display.....	3-15
3.5.6 List of List editor function.....	3-18
3.6 Specifications of the motion monitor function.....	3-20
3.6.1 PLC CPUs that can be monitored	3-20
3.6.2 Access ranges that can be monitored	3-20
3.6.3 Precautions for use of the motion monitor function	3-20
3.6.4 Memory space necessary to use the motion monitor function	3-20
3.7 Specifications of the Servo Amplifier Monitor Functions	3-21
3.7.1 List of servo amplifier models that can be monitored and functions.....	3-21
3.7.2 Access range that can be monitored	3-21
3.7.3 Precautions for use of the servo amplifier monitor functions	3-22
3.7.4 System configuration for servo amplifier connection	3-22
3.7.5 Monitor screen types and memory capacities necessary to use the servo amplifier monitor functions....	3-23

4 OPERATING THE UTILITY FUNCTION	4 - 1 to 4 - 21
---	------------------------

4.1 Utility function table	4 - 1
4.2 Selecting the utility function	4 - 2
4.3 Selecting the required function on the utility menu screen (Adjusting the brightness/contrast of the monitor screen).....	4 - 3
4.4 Copying the monitor data/OS data between the internal memory and memory card (Screen & OS copy)	4 - 5
4.5 Setting the operating environment of the GOT (Setup).....	4 - 7
4.6 Running diagnostic checks on GOT hardware (self-test).....	4 - 14
4.7 Displaying GOT memory information (memory information).....	4 - 15
4.8 Setting the Clock (Clock)	4 - 16
4.9 Displaying the display area cleanup screen (screen cleanup).....	4 - 17
4.10 Changing security levels (security password).....	4 - 18
4.11 Controlling limited access to the utility menu (password).....	4 - 19
4.12 Adjusting the brightness of the monitor screen on the dedicated screen (Brightness adjustment)	4 - 20

LADDER MONITOR FUNCTION

5 OPERATION PROCEDURES FOR THE LADDER MONITOR FUNCTION	5 - 1 to 5 - 2
---	-----------------------

5.1 Operation procedures before starting ladder monitoring.....	5 - 1
5.2 Operation procedures from display of user-created monitor screen to start of ladder monitoring.....	5 - 2

6 OPERATING THE VARIOUS LADDER MONITOR SCREENS	6 - 1 to 6 - 26
---	------------------------

6.1 Display screens.....	6- 1
6.2 Screen operation and screen changes when monitoring	6 - 3

6.2.1 Reading data from the PLC.....	6 - 3
6.2.2 Ladder read operation.....	6 - 9
6.2.3 Using the defect search	6 - 12
6.2.4 Touch search operation	6 - 16
6.2.5 Changing from one screen to another	6 - 18
6.3 Ladder monitor	6 - 19
6.3.1 Ladder monitor screen display and key functions.....	6 - 19
6.3.2 Precaution during ladder monitoring.....	6 - 21
6.3.3 Switching the display form (decimal/hexadecimal) and turning the comment display on/off	6 - 23
6.3.4 Changing the device value	6 - 24
6.3.5 About Hardcopy Output	6 - 25

7 ERROR DISPLAY AND HANDLING WITH LADDER MONITORING	7 - 1 to 7 - 2
--	-----------------------

SYSTEM MONITOR FUNCTION

8 OPERATION PROCEDURES FOR THE SYSTEM MONITOR FUNCTION	8 - 1 to 8 - 2
---	-----------------------

8.1 Operation procedures before starting system monitoring	8 - 1
8.2 Operation procedures from user-created monitor screen display to start of system monitoring	8 - 2

9 OPERATION OF THE VARIOUS SYSTEM MONITOR SCREENS	9 - 1 to 9 - 21
--	------------------------

9.1 Screen configuration, common operations and changing screens when monitoring.....	9 - 1
9.1.1 Basic screen configuration and key functions (menu).....	9 - 1
9.1.2 Switching the display form (decimal/hexadecimal) and turning the comment display on/off (FORM)	9 - 2
9.1.3 Specifying the monitor station and device (SET).....	9 - 4
9.1.4 Changing screens	9 - 6
9.2 Entry monitor	9 - 7
9.2.1 Basic operation.....	9 - 7
9.2.2 Entry monitor screen display and key functions.....	9 - 8
9.2.3 Deleting a registered device	9 - 9
9.3 Batch monitor	9 - 10
9.3.1 Basic operation.....	9 - 10
9.3.2 Batch monitor screen display and key functions.....	9 - 11
9.4 TC Monitor (monitor of timer and counter).....	9 - 12
9.4.1 Basic operation.....	9 - 12
9.4.2 TC Monitor screen display and key functions	9 - 13
9.5 BM Monitor (monitor of buffer memory)	9 - 14
9.5.1 Basic operation.....	9 - 14
9.5.2 BM Monitor screen display and key functions.....	9 - 15
9.6 Test.....	9 - 16
9.6.1 Basic operation.....	9 - 16
9.6.2 Quick test function	9 - 19

10 ERROR DISPLAY AND HANDLING WITH SYSTEM MONITORING	10 - 1 to 10 - 2
---	-------------------------

SPECIAL MODULE MONITOR FUNCTION

11 OPERATION PROCEDURES FOR SPECIAL MODULE MONITOR FUNCTION 11 - 1 to 11 - 2

- 11.1 Operation procedures before starting special module monitoring..... 11 - 1
- 11.2 Operation procedures from user-created monitor screen display to start of special module monitor 11 - 2

12 OPERATION OF EACH SPECIAL MODULE MONITOR SCREEN 12 - 1 to 12 -77

12.1	Screen configuration, common operation and changing screens when monitoring.....	12 - 1
12.1.1	Composition of system configuration screen and key functions.....	12 - 1
12.1.2	Setting method for remote station monitoring.....	12 - 3
12.1.3	Composition of PC Information screen and key functions (only when QCPU(Q mode) is used).....	12 - 4
12.1.4	Composition of Unit Detail info screen and key functions (only when QCPU(Q mode) is used).....	12 - 5
12.1.5	Monitor screen configuration and key functions.....	12 - 6
12.1.6	Specifying monitor module and selecting monitor menu.....	12 - 7
12.1.7	Test for special function module.....	12 - 8
12.1.8	Changing the screen.....	12 -10
12.2	A61LS module monitor.....	12 -11
12.3	AD61 module monitor.....	12 -11
12.4	A1SD61 module monitor.....	12 -12
12.5	A62DA-S1 module monitor.....	12 -13
12.6	A1S62DA module monitor.....	12 -13
12.7	A62LS module monitor.....	12 -14
12.8	A1S62RD module monitor.....	12 -15
12.9	A1S63DA module monitor.....	12 -16
12.10	A1S64DA module monitor.....	12 -17
12.11	A68AD module monitor.....	12 -18
12.12	A1S68AD module monitor.....	12 -19
12.13	A68ADN module monitor.....	12 -20
12.14	A68RD module monitor.....	12 -21
12.15	A1S68DAI, A1S68DAV module monitor.....	12 -22
12.16	A616AD module monitor.....	12 -23
12.17	A616DAI, A616DAV module monitor.....	12 -25
12.18	A616TD module monitor.....	12 -26
12.19	AD70, A1SD70 module monitor.....	12 -29
12.20	A70D module monitor.....	12 -31
12.21	AD71 Module monitor.....	12 -33
12.22	AD72, A1SD71 module monitor.....	12 -36
12.23	AD75, A1SD75 module monitor.....	12 -39
12.24	AJ71PT32-S3 and A1SJ71PT32-S3 module monitor.....	12 -45
12.25	AJ71ID1 (ID2)-R4 and A1SJ71ID1 (ID2)-R4 module monitor.....	12 -47
12.26	A84AD module monitor.....	12 -48
12.27	A1S64TCTT(BW)-S1 and A1S64TCRT(BW)-S1 module monitor.....	12 -49
12.28	Q64AD, Q68ADV, Q68ADI module monitor.....	12 -51
12.29	Q62DA, Q64DA module monitor.....	12 -52
12.30	QD62,QD62D module monitor.....	12 -53
12.31	QD75P , QD75D module monitor.....	12 -54
12.32	QD75M module monitor.....	12 -64

13 OPERATING I/O MODULE MONITOR SCREENS	13 - 1 to 13 - 2
--	-------------------------

- 13.1 Specifying the module to be monitored 13 - 1
- 13.2 Monitor screen configuration and key functions 13 - 2

14 ERROR DISPLAY AND HANDLING WITH SPECIAL MODULE MONITORING	14 - 1 to 14 - 2
---	-------------------------

NETWORK MONITOR FUNCTION

15 OPERATING THE NETWORK MONITOR FUNCTION	15 - 1 to 15 - 2
--	-------------------------

- 15.1 Steps in getting started with the network monitor function 15 - 1
- 15.2 Steps in starting the network monitor function from the user-created monitor screen 15 - 2

16 SWITCHING THE NETWORK MONITOR SCREENS	16 - 1 to 16 - 2
---	-------------------------

17 USING THE NETWORK MONITOR SCREENS	17 - 1 to 17 - 18
---	--------------------------

- 17.1 Own station monitor 17 - 1
 - 17.1.1 Display contents and keys functions: own station monitor 17 - 1
- 17.2 Detailed own station monitor 17 - 3
 - 17.2.1 Display contents and keys functions: acting as a MELSECNET/B or MELSECNET (II) master station 17 - 3
 - 17.2.2 Display contents and keys functions: acting as a MELSECNET/B or MELSECNET (II) local station .. 17 - 4
 - 17.2.3 Display contents and keys functions: acting as a MELSECNET/10 Control station/ordinary Station ... 17 - 5
 - 17.2.4 Display contents and keys functions: acting as a MELSECNET/10 remote master station 17 - 8
- 17.3 Other station monitor 17 - 11
 - 17.3.1 Display contents and keys functions: other station monitor menu 17 - 11
 - 17.3.2 Display contents and keys functions: other station communication status monitor 17 - 12
 - 17.3.3 Display contents and keys functions: other station data link status monitor 17 - 13
 - 17.3.4 Display contents and keys functions: other station parameter status monitor 17 - 14
 - 17.3.5 Display contents and keys functions: other station CPU action status monitor 17 - 15
 - 17.3.6 Display contents and keys functions: other station CPU RUN status monitor 17 - 16
 - 17.3.7 Display contents and keys functions: other station loop status monitor 17 - 17

18 ERROR DISPLAYS AND COUNTERMEASURES WHEN MONITORING NETWORKS	18 - 1 to 18 - 2
---	-------------------------

LIST EDITOR FUNCTION

19 OPERATION PROCEDURES FOR THE LIST EDITOR FUNCTION	19 - 1 to 19 - 5
---	-------------------------

- 19.1 Operation procedures before starting the list edit 19 - 1
- 19.2 Operation procedures from user-created monitor screen display to starting list editing 19 - 2
 - 19.2.1 Operation of keyword input 19 - 3
 - 19.2.2 Selection and operation of mode 19 - 5

20 OPERATION OF EDITING SCREEN FOR EACH LIST	20 - 1 to 20 - 16
---	--------------------------

20.1 Basic operation of key input.....	20 - 1
20.1.1 Switching of valid key (function indicated at the upper/lower part of the key).....	20 - 1
20.1.2 Command input procedures.....	20 - 2
20.1.3 Action if an incorrect key is input.....	20 - 6
20.2 Basic operation of list edit.....	20 - 7
20.2.1 Reading sequence program.....	20 - 7
20.2.2 Changing (overwriting) command.....	20 - 8
20.2.3 Adding (inserting) command.....	20 - 9
20.2.4 Deleting command.....	20 - 10
20.2.5 Using Help function.....	20 - 11
20.3 Operation procedure list of list edit.....	20 - 13
20.3.1 Common operation.....	20 - 13
20.3.2 Operation in Write mode (W).....	20 - 13
20.3.3 Operation in Read mode (R).....	20 - 14
20.3.4 Operation in Insert mode (I).....	20 - 14
20.3.5 Operation in Delete (D) mode.....	20 - 14
20.3.6 Operation in Parameter mode (P).....	20 - 15
20.3.7 Operation in Other modes (O).....	20 - 16

21 ERROR DISPLAY AND CORRECTIVE ACTIONS FOR LIST EDIT	21 - 1 to 21 - 6
--	-------------------------

21.1 Error detected with the list editor function.....	21 - 1
21.2 Error of PLC CPU.....	21 - 4
21.3 Error using list editor function on the link system.....	21 - 5

MOTION MONITOR FUNCTION

22 OPERATION PROCEDURES FOR MOTION MONITOR FUNCTION	22 - 1 to 22 - 4
--	-------------------------

22.1 Operation procedures before starting motion monitoring.....	22 - 1
22.2 Operation procedures from user-created monitor screen display to start of motion monitor.....	22 - 2
22.2.1 Password entry operation procedure.....	22 - 4

23 OPERATIONS OF VARIOUS MOTION MONITOR SCREENS	23 - 1 to 23 - 16
--	--------------------------

23.1 Screen layout, common operations and screen changes for monitoring.....	23 - 1
23.1.1 System configuration screen layout and key functions.....	23 - 1
23.2 Changing the screen.....	23 - 2
23.3 Motion monitor.....	23 - 3
23.3.1 Display data and key functions of present value monitor screen.....	23 - 4
23.3.2 Display data and key functions of SFC error history screen.....	23 - 5
23.3.3 Display data and key functions of error list screen.....	23 - 6
23.3.4 Display data and key functions of error list designated-axis screen.....	23 - 7
23.3.5 Display data and key functions of positioning monitor screen.....	23 - 9
23.3.6 Display data and key functions of servo monitor screen.....	23 - 11
23.3.7 Display data and key functions of present value history monitor screen.....	23 - 12
23.4 Parameter setting.....	23 - 14

23.4.1 Display data and key functions of parameter setting screen	23 -14
23.4.2 Parameter setting operation	23 -15
23.5 About Hardcopy Output	23 -16

24 ERROR DISPLAY AND HANDLING WITH MOTION MONITORING	24 - 1 to 24 - 2
---	-------------------------

SERVO AMPLIFIER MONITOR FUNCTION

25 OPERATION PROCEDURES FOR SERVO AMPLIFIER MONITOR FUNCTION	25 -1 to 25 - 2
---	------------------------

25.1 Operation procedures before starting motion monitoring	25 - 1
25.2 Operation procedures from user-created monitor screen display to start of motion monitor	25 - 2

26 OPERATIONS OF SERVO AMPLIFIER MONITOR SCREENS	26 - 1 to 26 - 31
---	--------------------------

26.1 Screen Transition	26 - 1
26.2 About the Servo Amplifier Monitor Functions	26 - 2
26.3 Setup	26 - 3
26.3.1 Setup screen	26 - 3
26.4 Monitor Functions	26 - 4
26.4.1 Monitor screen	26 - 4
26.5 Alarm Function	26 - 6
26.5.1 Alarm display screen	26 - 7
26.5.2 Alarm history screen	26 - 8
26.6 Diagnostics Function	26 - 9
26.6.1 DI/DO display screen	26 -11
26.6.2 Function device display screen	26 -12
26.6.3 Amplifier information display screen	26 -13
26.6.4 ABS data display screen	26 -14
26.6.5 Unit composition list display screen	26 -15
26.7 Parameter Setting	26 -16
26.7.1 Password entry operation procedure	26 -17
26.7.2 Parameter setting screen	26 -18
26.7.3 Parameter setting operation	26 -20
26.8 Test Operations	26 -22
26.8.1 Precautions for test operations	26 -25
26.8.2 Preparations for test operations	26 -26
26.8.3 JOG operation screen	26 -27
26.8.4 Positioning operation screen	26 -28
26.8.5 Motorless operation screen	26 -29
26.8.6 DO forced output screen	26 -30
26.9 About Hardcopy Output	26 -31

27 ERROR INDICATIONS AND CORRECTIVE ACTIONS FOR SERVO AMPLIFIER MONITOR	27 - 1 to 27 - 2
--	-------------------------

INDEX	Index - 1 to Index - 2
--------------	-------------------------------

About Manuals

The following manuals are relevant to this product.
Refer to the following list and order the required manuals.

- Detailed manuals

Manual name	Manual number (Model code)
A985GOT/A975GOT/A970GOT/A960GOT User's Manual Explains the specifications, general system configuration, component devices, part names, option unit loading methods, installation and wiring methods, maintenance and inspection methods, and error codes of A985GOT/A975GOT/A970GOT/A960GOT unit. (Available as option)	SH-4005 (1DM099)
A950GOT/A951GOT/A953GOT/A956GOT User's Manual Explains the specifications, general system configuration, component devices, part names, option unit loading methods, installation and wiring methods, maintenance and inspection methods, and error codes of A950GOT/A951GOT/A953GOT/A956GOT unit. (Available as option)	SH-080018 (1DM103)

- Relevant Manuals

For relevant manual, refer to the PDF manual stored within the drawing software.

Abbreviations and generic terms in this manual

Abbreviations, generic terms and special terms used in this manual are described as follows:

Abbreviations, generic terms and special terms	Description	
GOT	A985GOT-V	Generic term of A985GOT-TBA-V and A985GOT-TBD-V
	A985GOT	Generic term of A985GOT-TBA, A985GOT-TBD and A985GOT-TBA-EU
	A975GOT	Generic term of A975GOT-TBA-B, A975GOT-TBD-B, A975GOT-TBA, A975GOT-TBD and A975GOT-TBA-EU
	A970GOT	Generic term of A970GOT-TBA-B A970GOT-TBD-B, A970GOT-TBA, A970GOT-TBD, A970GOT-SBA, A970GOT-SBD, A970GOT-LBA, A970GOT-LBD, A970GOT-TBA-EU and A970GOT-SBA-EU
	A97*GOT	Generic term of A975GOT and A970GOT
	A960GOT	Generic term of A960GOT-EBA, A960GOT-EBD and A960GOT-EBA-EU
	A956GOT	Generic term of A956GOT-TBD, A956GOT-SBD, A956GOT-LBD, A956GOT-TBD-M3, A956GOT-SBD-M3 and A956GOT-LBD-M3
	A956WGOT	Generic term of A956WGOT-TBD
	A953GOT	Generic term of A953GOT-TBD, A953GOT-SBD, A953GOT-LBD, A953GOT-TBD-M3, A953GOT-SBD-M3 and A953GOT-LBD-M3
	A951GOT	Generic term of A951GOT-TBD, A951GOT-SBD, A951GOT-LBD, A951GOT-TBD-M3, A951GOT-SBD-M3 and A951GOT-LBD-M3
	A951GOT-Q	Generic term of A951GOT-QTBD, A951GOT-QSBD, A951GOT-QLBD, A951GOT-QTBD-M3, A951GOT-QSBD-M3 and A951GOT-QLBD-M3
	A950GOT	Generic term of A950GOT-TBD, A950GOT-SBD, A950GOT-LBD, A950GOT-TBD-M3, A950GOT-SBD-M3 and A950GOT-LBD-M3
	A950 handy GOT	Generic term of A953GOT-SBD-M3-H, A953GOT-LBD-M3-H, A950GOT-SBD-M3-H and A950GOT-LBD-M3-H
	A95*GOT	Generic term of A956GOT, A953GOT, A951GOT, A951GOT-Q, A950GOT and A950 handy GOT
Communication board	Bus connection board	Generic term of A9GT-QBUSS, A9GT-QBUS2S, A9GT-BUSS and A9GT-BUS2S
	Serial communication board	Generic term of A9GT-RS4, A9GT-RS2 and A9GT-RS2T
Communication unit	Bus connection unit	Generic term of A9GT-QBUS2SU, A9GT-BUS2SU, A9GT-BUS2SU, A7GT-BUSS and A7GT-BUS2S
	Data link unit	Generic term of A7GT-J71AP23, A7GT-J71AR23 and A7GT-J71AT23B
	Network unit	Generic term of A7GT-J71LP23 and A7GT-J71BR13
	CC-Link communication unit	Generic term of A8GT-J61BT13 and A8GT-J61BT15
	Ethernet unit	Generic term of A9GT-J71E71-T
Option	Protection sheet	Abbreviation of A9GT-80PSC, A9GT-70PSC, A9GT-60PSC and A9GT-50PSC type transparent protection sheets
	Backlight	Abbreviation of A9GT-80LTT, A9GT-70LTTB, A9GT-70LTT, A9GT-70LTS and A9GT-50LT type backlights
	Debug stand	Abbreviation of A9GT-80STAND, A9GT-70STAND and A9GT-50STAND type debug stand
	PC card (memory card)	Abbreviation of PC card with PCMCIA Ver.2.1
	Flash PC card	Generic term of A9GTMEM-10MF, A9GTMEM-20MF and A9GTMEM-40MF
	Compact flash PC card	Compact flash PC card compliant with Compact FlashTM
	Memory board	Abbreviation of A9GT-FNB, A9GT-FNB1M, A9GT-FNB2M, A9GT-FNB4M, A9GT-FNB8M, A9GT-QFNB, A9GT-QFNB4M, A9GT-QFNB8M type option function memory board
	Attachment	Generic term of A77GT-96ATT/A85GT-95ATT/A87GT-96ATT/A87GT-97ATT attachments
	Ten-key Panel	Abbreviation of A8GT-TK ten-key Panel
	A7GT-CNB	Abbreviation of A7GT-CNB bus connector conversion box
A9GT-QCNB	Abbreviation of A9GT-QCNB bus connector conversion box	
Option unit	External I/O unit	Abbreviation of A9GT-70KBF and A8GT-50KBF type external I/O interface unit
	Printer interface unit	Abbreviation of A9GT-50PRF type printer interface unit
	Memory card interface unit	Abbreviation of A1SD59J-MIF memory card interface unit
	Video/RGB mixed input interface unit	Abbreviation of A9GT-80V4R1 type Video/RGB mixed input interface unit
	Video input interface unit	Abbreviation of A9GT-80V4 type Video input interface unit
	RGB input interface unit	Abbreviation of A9GT-80R1 type RGB input interface unit
Software	GT Works Version 5	Abbreviation of SW5D5C-GTWORKS-E software
	GT Designer Version 5	Generic term of SW5D5C-GOTR-PACKE software package and SW5D5C-GOTR-PACKEV software package
	GT Designer	Abbreviation of image creation software GT Designer for GOT900
	GT Simulator	Abbreviation of GT Simulator screen simulator GOT900
	GT Converter	Abbreviation of data conversion software GT Converter for GOT900
	GT Debugger	Abbreviation of debugging software GT Debugger
	GT Manager	Abbreviation of GT Manager data editing software for GOT900
	GT SoftGOT	Abbreviation of GT SoftGOT monitoring software
	GX Developer	Generic term of SW□D5C-GPPW-E/SW□D5F-GPPW-E software packages
	GX Simulator	Generic term of SW□D5C-LLT-E ladder logic test tool function software packages (SW5D5C-LLT-E or later)

Abbreviations, generic terms and special terms		Description
CPU	QCPU (Q Mode)	Generic term of Q00JCPU, Q00CPU, Q01CPU, Q02CPU, Q02HCPU, Q06HCPU, Q12HCPU, Q25HCPU, Q12PHCPU and Q25PHCPU CPU units
	QCPU (A Mode)	Generic term of Q02CPU-A, Q02HCPU-A and Q06HCPU-A CPU units
	QCPU	Generic term of QCPU (Q Mode) and QCPU (A Mode)
	QnACPU (Large Type)	Generic term of Q2ACPU, Q2ACPU-S1, Q3ACPU, Q4ACPU and Q4ARCPU CPU units
	QnACPU (Small Type)	Generic term of Q2ASCPU, Q2ASCPU-S1, Q2ASHCPU and Q2ASHCPU-S1 CPU units
	QnACPU	Generic term of QnACPU (Large Type) and QnACPU (Small Type)
	AnUCPU	Generic term of A2UCPU, A2UCPU-S1, A3UCPU and A4UCPU CPU units
	AnACPU	Generic term of A2ACPU, A2ACPU-S1 and A3ACPU CPU units
	AnNCPUCPU	Generic term of A1NCPUCPU, A2NCPUCPU, A2NCPUCPU-S1 and A3NCPUCPU CPU units
	ACPU (Large Type)	Generic term of AnUCPU, AnACPU and AnNCPUCPU CPU units
	A2US(H)CPU	Generic term of A2USCPU, A2USCPU-S1 and A2USHCPU-S1 CPU units
	AnS(H)CPU	Generic term of A1SCPU, A1SHCPU, A2SCPU and A2SHCPU CPU units
	A1SJ(H)CPU	Generic term of A1SJCPU-S3 and A1SJHCPU CPU units
	ACPU (Small Type)	Generic term of A2US(H)CPU, AnS(H)CPU and A1SJ(H)CPU CPU units
	ACPU	Generic term of ACPUCPU (Large Type), ACPUCPU (Small Type) and A1FXCPU CPU units
	FXCPU	Generic term of FX0 series, FX0N series, FX0S series, FX1 series, FX1N series, FX1S series, FX2 series, FX2C series, FX2N series, FXINS series and FX2NC series CPU unit
Motion controller CPU	Generic term of A273UCPU, A273UHCPU, A273UHCPU-S3, A171SCPU-S3, A171SHCPU, A172SHCPU, Q172CPU, Q173CPU CPU unit	
FA controller	Generic term of LM610, LM7600, LM8000 CPU unit	
Peripheral connection unit	G4	Abbreviation of AJ65BT-G4-S3
Ethernet unit	E71	Generic term of AJ71E71-S3, A1SJ71E71-B2-S3, A1SJ71E71-B5-S3, AJ71E71N-B2, AJ71E71N-B5T, A1SJ71E71N-B2 and A1SJ71E71N-B5T
	QE71	Generic term of AJ71QE71, A1SJ71QE71-B2, AJ71QE71-B5, A1SJ71QE71-B5, AJ71QE71N-B2, AJ71QE71N-B5T, A1SJ71QE71N-B2 and A1SJ71QE71N-B5T
	Q series-compatible E71	Generic term of QJ71E71, QJ71E71-B2 and QJ71E71-100
Other PLC	Omron PLC	Generic term of C200HS, C200H, C200H α series(C200HX, C200HG, C200HE), CQM1, C1000H, C2000H, CV500, CV1000, CV2000, CVM1-CPU11, CVM1-CPU21, CS1, CJ1 CPU unit
	Yasukawa PLC	Generic term of GL60S, GL60H, GL70H, GL120, GL130, CP-9200SH, CP-9300MS, MP-920, MP-930, MP-940, CP-9200(H) and PROGIC-8 CPU unit
	SLC500 Series	Generic term of SLC500-20, SLC500-30, SLC500-40, SLC5/01 SLC5/02, SLC5/03, SLC5/04 SLC5/05
	MicroLogix1000 Series	Generic term of 1761-L10BWA, 1761-L10BWB, 1761-L16AWA, 1761-L16BWA, 1761-L16BWB, 1761-L16BBB, 1761-L32AWA, 1761-L32BWA, 1761-L32BWB, 1761-L32BBB, 1761-L32AAA, 1761-L20AWA-5A, 1761-L20BWA-5A, 1761-L20BWB-5A
	MicroLogix1500 Series	Abbreviation of 1764-LSP
	Allen-Bradley PLC	Generic term of SLC 500 Series, MicroLogix1000 Series, MicroLogix1500 Series
	Sharp PLC	Generic term of JW-21CU, JW-22CU, JW-31CUH, JW-32CUH, JW-33CUH, JW-50CUH, JW-70CUH, JW-100CUH CPU unit
	PROSEC T Series	Generic term of T2(PU224 type), T2E, T2N, T3, T3H CPU unit
	PROSEC V Series	Abbreviation of Model3000(S3) CPU unit
	Toshiba PLC	Generic term of PROSEC T Series and PROSEC V Series
	SIEMENS PLC	Generic term of SIMATIC S7-300 Series and SIMATIC S7-400 Series CPU unit
	Large type H series	Generic term of H-302(CPU2-03H), H-702(CPU2-07H), H-1002(CPU2-10H), H-2002(CPU2-20H), H-4010(CPU3-40H), J-300(CPU-03Ha), H-700(CPU-07Ha), H-2000(CPU-20Ha)
	H200 to 252 Series	Generic term of H-200(CPU-02H, CPE-02H), H-250(CPU21-02H), H-252(CPU22-02H), H-252B(CPU22-02HB), H-252C(CPU22-02HC, CPE22-02HC)
	H Series board type	Generic term of H-20DR, H-28DR, H-40DR, H-64DR, H-20DT, H-28DT, H-40DT, H-64DT, HL-40DR, HL-64DR
	EH-150 Series	Generic term of EH-CPU104, EH-CPU208, EH-CPU308, EH-CPU316
	HITACHI PLC (HIDIC H Series)	Generic term of large type H series, H-200 to 252 Series H Series board type, EH-150 Series
Matsushita Electric Works PLC	Generic term of FP0-C16CT, FP0-C32CT, FP1-C24C, FP1-C40C, FP2, FP3, FP5, FP10(S), FP10SH, FP-M(C20TC) and FP-M(C32TC)	
Others	Memory	abbreviation of memory (flash memory) in the GOT
	OS	Abbreviation of GOT system software
	Object	Setting data for dynamic image
	Personal Computer	Personal computer where the corresponding software package is installed
	Servo amplifier	Generic term of the MR-J2S-□A, MR-J2S-□CP and MR-J2M A series

* In this manual, the following products are called by new names.

Old Name	New Name	Remarks
GPPW	GX Developer	Generic term of SW□D5C-GPPW-E/SW□D5F-GPPW-E software packages

CHAPTER1 OVERVIEW

This manual that can be used on a GOT with an operating system installed. These functions include the utility function, ladder monitor function, system monitor function, special module monitor function, network monitor function, list editor function, motion monitor function and servo amplifier monitor function.

POINT

Note that some functions cannot be performed depending on the used GOT and the target CPU/connection form.
 Refer to Chapter 2 for more information on the functions available for each GOT and the restrictions on the functions per target CPU and connection form.

1.1 Features

The monitor functions described in this manual are intended to improve the efficiency of trouble-shooting and maintenance operations for the PLC system.
 The features of each monitor function are explained in the following sections.

1.1.1 Features of the utility function

The utility function enables you to use GOT setup and self-tests. To use the utility function, you need to install an operating system for the utility function on the GOT built-in internal memory by using GT Designer. The features of the utility function are shown below.

POINT

Some of the utility functions cannot be used with GT SoftGOT. Refer to the GT SoftGOT Version 5 Operating Manual for the utility functions available for GT SoftGOT.

(1) The brightness of a monitor screen can be adjusted (see Section 4.3 for details).

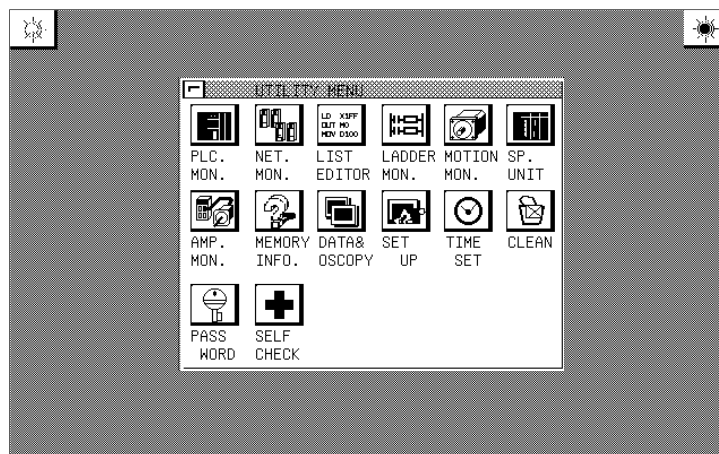

1

- (2) The screen and OS data can be copied between the internal memory and memory card (see Section 4.4 for details).

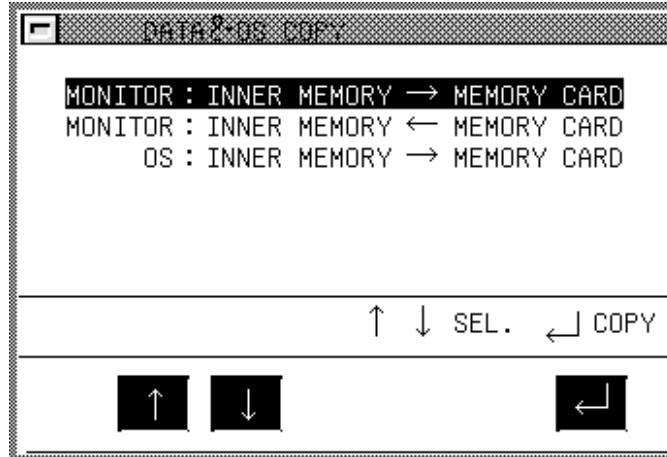

The data monitored can be copied to and from the GOT built-in internal memory or a memory card installed on the GOT.
 The OS data can only be copied from the GOT to the memory card.

- (3) Setting a use environment of the GOT (see Section 4.5 for details).

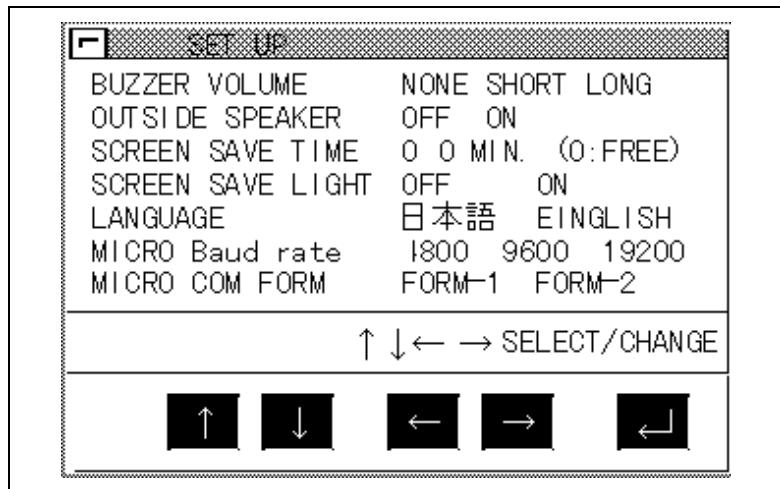

You can set the operating environment of the GOT such as the beep sound, message display language and screen saver's idle time. When using the A985GOT, you can also make settings on the Human sensor.

(4) Running diagnostic checks on GOT hardware (see Section 4.6).

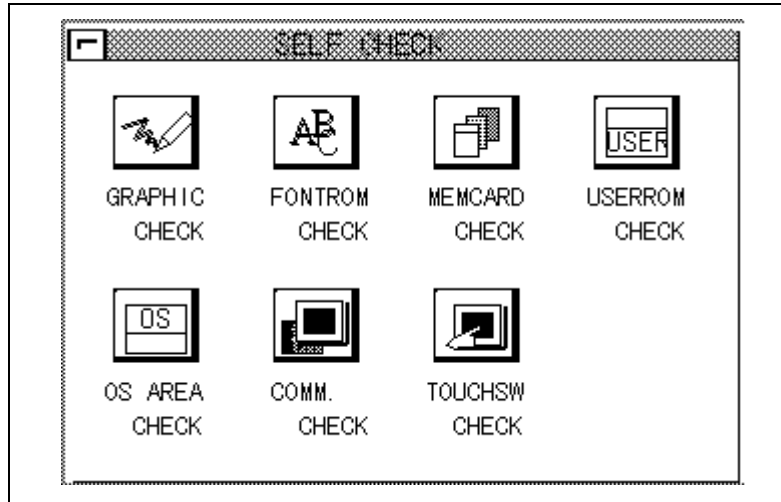

You can run diagnostic checks on the GOT hardware, including the image check, font check, memory card check and so on.

(5) Other functions (see Section 4.7 for details)

- Displaying data on available space in the GOT internal memory.
- Adjusting the clock of the PLC CPU.
- Displaying the display area cleanup screen.
- Changing security levels.
- Limiting access to the Utility Menu screen.

1.1.2 Features of the ladder monitor function

Installing the ladder monitor function operating system into the GOT built-in memory using the GT Designer enables ladder monitoring of the PLC CPU program as shown in a ladder diagram. The features of the ladder monitor function are shown below.

(1) Monitoring based on ladder symbols (see Section 6.3 for details)

(Sample display) Ladder monitor screen

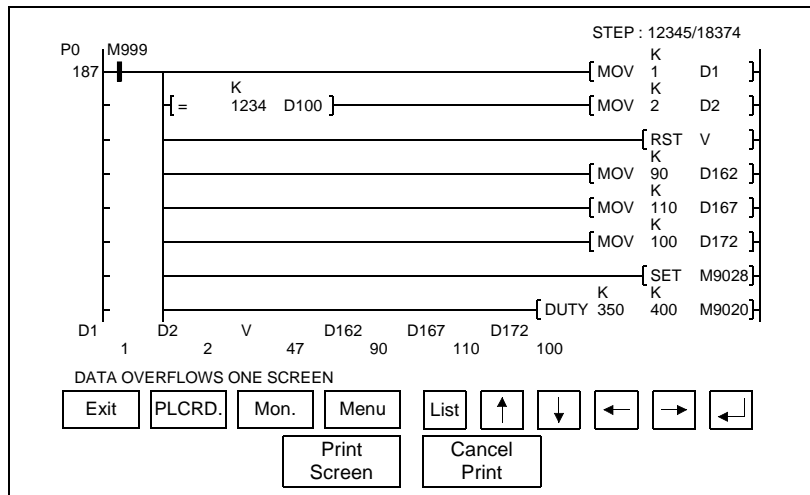

REMARK

The **Print Screen** and **Cancel Print** buttons are not displayed on the A956WGOT or the GOT whose display screen type is the EL.

(1) Ladder monitor screen

A maximum of 8 lines (max. 11 contact points per line; with 12 contact points or more, the line returns) of a sequence program are displayed on one screen. Also, for the current values and other settings of word devices, a maximum of 8 devices are displayed (With 9 devices or more, use the arrow keys to switch displays.).

REMARK

Depending on the GOT model, a display is provided on the MELSEC-Q ladder monitor screen as indicated below.

- A985GOT(-V): Max. 15 lines displayed (1 line: Max. 11 contacts)
- A956WGOT: Max. 5 lines displayed (1 line: Max. 7 contacts)

(2) The display format can be changed to show comments for devices (see Section 6.2.2 for details).

(Sample display) Ladder monitor screen

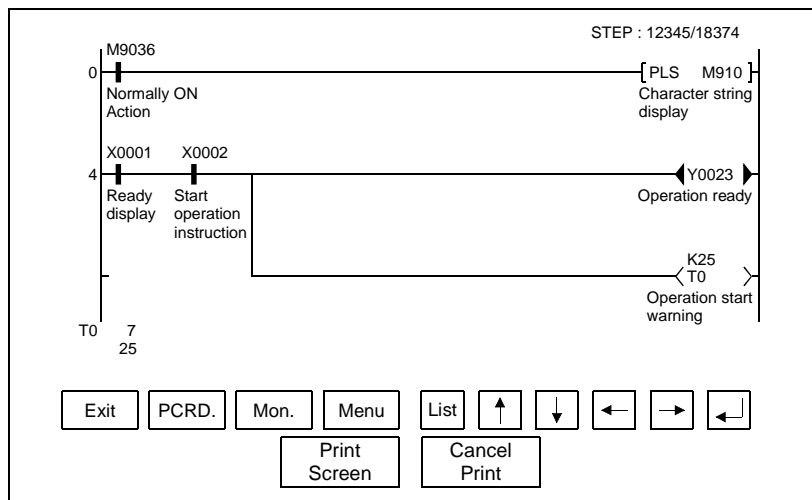

1) Switching the display format

The current values monitor of the word devices at the bottom of the screen are executed in decimal or hexadecimal format.

2) Displaying device comments

Comments of for the device used in the PLC program (comments that are written into the PLC CPU) are displayed.

(3) Monitoring other stations

Other stations in data link systems, network system or CC-Link system, including the GOT (or stations connected to the GOT), can be monitored.

1.1.3 Features of the system monitor function

Installing the screen monitor function operating system into the GOT built-in memory using the GT Designer enables monitoring and testing of the buffer memory for the PLC CPU program and the special functions module. The features of the system monitor function are shown below.

(1) Any desired device can be monitored, using 4 dedicated screens

The system monitor function provides an entry monitor, a batch monitor, and a buffer memory monitor, enabling monitoring of any device, for complete flexibility in any application.

Entry monitor

DEVICE MONITOR				TEST	MENU	FORM	SET
NETWK No. [0]		STATION[FF]					
D	15	-2147483648	DW				
D	10	-32767					
X	001	●					
M	25	○					
Y	70	●					
W	200	43					
R	50	68378428	DW				
D	300	30000					

- Up to 8 points for a PLC CPU device registered by the user can be monitored in one window (see Section 9.2).

Batch monitor

BATCH MONITOR				TEST	MENU	FORM	SET
NETWK No. [0]		STATION[FF]					
D	10	32767	D	18	-500		
D	11	0	D	19	3234		
D	12	0	D	20	0		
D	13	-1	D	21	0		
D	14	0	D	22	0		
D	15	3	D	23	-32768		
D	16	0	D	24	0		
D	17	0	D	25	0		

- Up to 16 points subsequent to a PLC CPU device specified by the user can be monitored in one window (see Section 9.3).

T/C monitor

TC MONITOR				TEST	MENU	FORM	SET
NETWK No. [0]		STATION[FF]					
T	0 PV	0 SV	0	↑	○	△	
[Production line A]							
T	1 PV	0 SV	0	↑	○		
[Production line B]							
T	2 PV	150 SV	150	■	●		
[Production line C]							
T	3 PV	0 SV	0	↑	○	▽	
[Production line D]							

- Up to 8 points, including the current value, set value, contact point, and coil can be monitored in a window subsequent to a PLC CPU timer (T)/counter (C) specified by the user (see Section 9.4).

Buffer memory monitor

BM MONITOR				TEST	MENU	FORM	SET
NETWK No. [0]		STATION[FF]					
I/O NO[1]							
BM	1110	-32767	BM	1118	0		
BM	1111	64	BM	1119	0		
BM	1112	149	BM	1120	150		
BM	1113	-1111	BM	1121	131		
BM	1114	126	BM	1122	-32768		
BM	1115	160	BM	1123	555		
BM	1116	255	BM	1124	2368		
BM	1117	1200	BM	1125	11000		

- Up to 16 points subsequent to the buffer memory of a special function module specified by the user can be monitored in one window (see Section 9.5).

- With the GOT, the full screen can be divided into four windows and separate monitoring carried out in all four windows simultaneously.

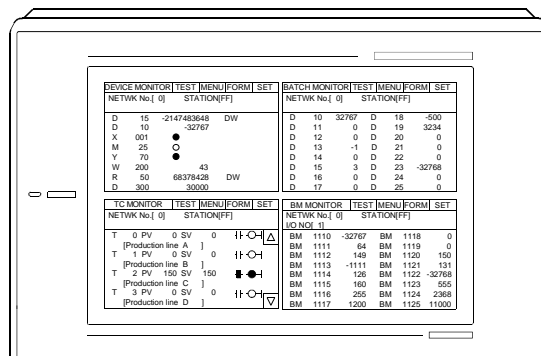

(2) Data can be changed by test operation (see Section 9.6 for details).

(Test sample)

When M0 is on

When changing D0 present value

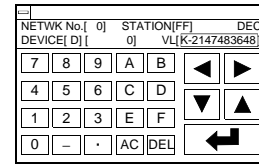
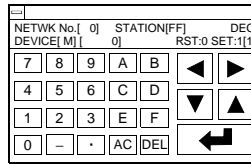

1) Test for bit device

Device specified by user is turned on or off.

2) Test for word device

Writes designated value into device specified by user.

3) Test for timer/counter

Writes in designated value as current value or set values of device specified by user.

4) Test for buffer memory

Writes designated value into buffer memory specified by user.

(3) Display format can be changed and device comments can be displayed (see Section 9.1.2 for details).

(Sample display)

For entry monitor
(comment display)

For batch monitor
(hexadecimal display)

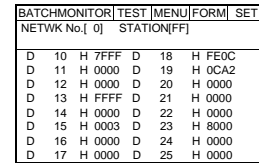
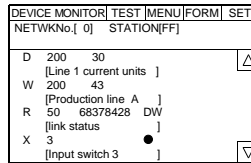

1) Changing display format

The word device values for the entry monitor, batch monitor, T/C monitor, and the buffer memory monitor are monitored in decimal or hexadecimal format.

2) Device comment display

When the PLC CPU device is monitored, the comments written into the PLC CPU are displayed.

(4) Other stations can be monitored.

Other stations in data link systems, network systems or CC-Link systems, including the GOT (or stations connected to the GOT), can be monitored.

1.1.4 Features of the special module monitor function

Installing (or downloading) the special module monitor function operating system and special module monitor data into the GOT built-in memory using the GT Designer enables monitoring and changing of data in the special function module buffer memory, using dedicated screens.

Signal statuses of I/O modules can also be monitored.

The features of the special module monitor function are shown below.

- (1) Monitoring can be done with dedicated screens (see Section 12.2 for details). Monitoring is carried out using dedicated screens provided by the manufacturer for the special function module and I/O module. It is not necessary for the user to create monitor screens.

(Sample display 1: for special function module)

Menu screen after module selection

Monitor screen after menu selection

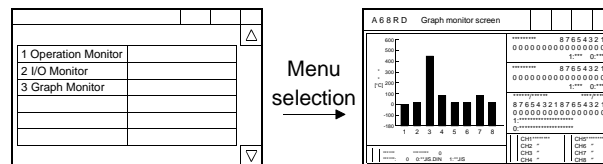

(Sample display 2: for I/O module)

Monitor screen

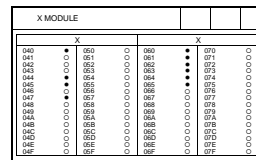

1) Menu screen

The menu is displayed classified into monitor items for the special function module only.

The object monitor screen is displayed by selecting the item from the menu.

2) Monitor screen

With the special function module, the buffer memory contents and the status of the PLC CPU I/O signals are monitored using text, numbers, and graphs. With the I/O module, the status of I/O signals to and from an external module is monitored.

(2) Data can be changed by writing (see Section 12.1.5. for details).

(Writing example)

Monitor screen

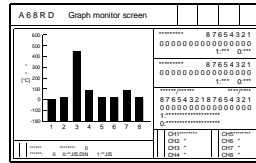

When changing channel that can be changed

Menu selection →

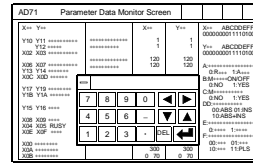

- 1) The designated values are written into the user-specified buffer memory by writing the values from the monitor.
 - 2) When changing the buffer memory data, input the numeric value using the auto display key window and write it into the buffer memory.
- (3) Special module monitor data can be allocated as user monitor screen data. The special module monitor data installed in the computer can be allocated to serve as user monitor screen data. To do this, the steps below are required.
- 1) Using the Copy function, allocate special module monitor data from another project as user monitor screen data.
 - 2) Correct the data to match the system used for the BM initial buffer memory number of the Object function which has been set.

1.1.5 Features of the network monitor function

To use the network monitor function, you first must install an operating system (OS) for the network monitor function on your GOT by using GT Designer. This enables you to monitor the status of the MELSECNET/B, MELSECNET (II), and MELSECNET/10 networks. The following describes the features of the network monitor function.

- (1) Network monitor screens are selectable on the own station monitor screen to monitor the own station and other stations on a network.

The own station monitor screen enables you to monitor the status of all the network lines connected to the own station.

A touch of the screen will guide you through various monitor screens to monitor the status of the own station and other stations on a network.

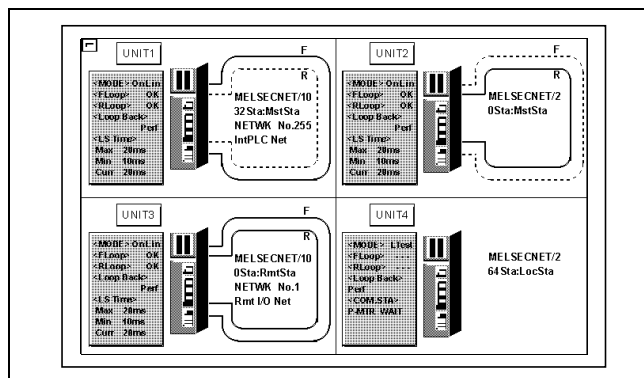

- (2) Network information can be obtained from the own station monitor screen.

Dedicated monitor screens are available for each category of station classification, depending on the role that is played by the own station.

- Network category: MELSECNET/B, MELSECNET (II) master station
- MELSECNET/B, MELSECNET (II) local station
- MELSECNET/10 control station/ordinary station
- MELSECNET/10 remote master station

(Sample display) MELSECNET/B, MELSECNET (II) master station

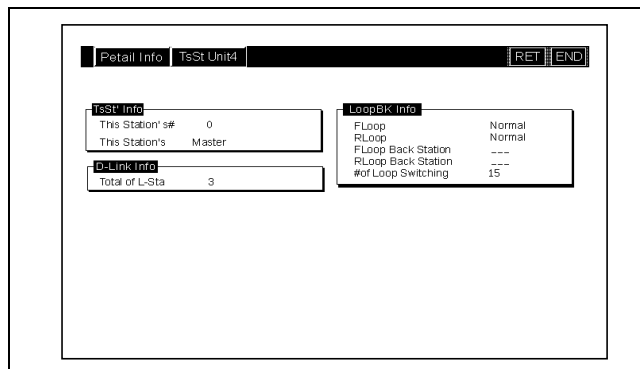

(3) The status of other stations can be monitored on the other-station monitor screen. The other-station monitor screen provides the following type of information on the status of other stations connected on a network:

- Communications status of each station
- Data link status of each station
- Parameters status of each station
- CPU action status of each station
- CPU RUN status of each station
- Loop status of each station

(Sample display) Other station monitor menu screen

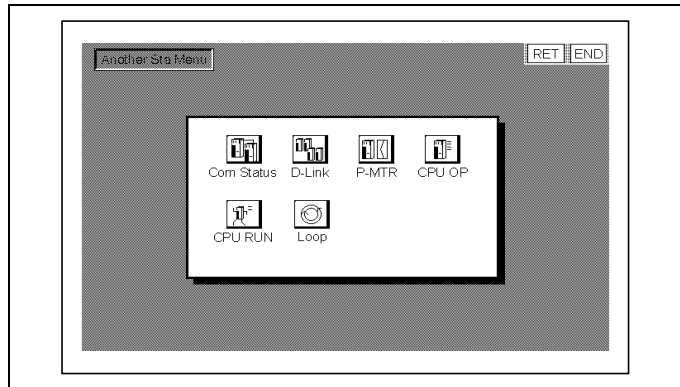

Other station's communications status monitor screen

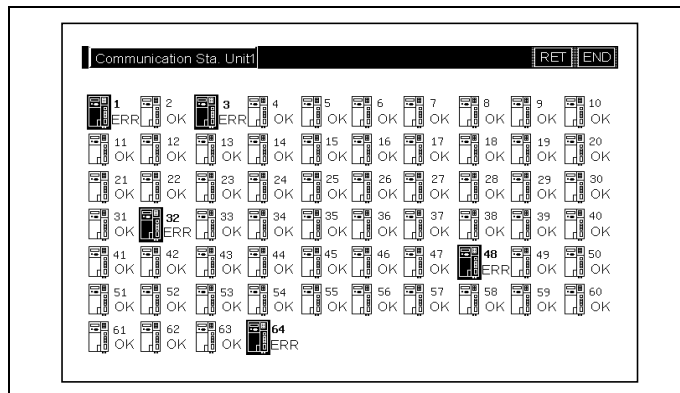

1.1.6 Features of the List editor function

Installation of the List editor function OS into the memory with the GT Designer allows for list edit of the sequence program in the ACPUL.

The following shows features of the List editor function.

(1) Easy parameters and sequence program maintenance

Simple key operations allow checks, partial modifications, changes and additions of the parameters and the sequence program in the PLC CPU.

Without peripheral equipment other than the GOT, the sequence program can be simply edited.

Example of command change in the sequence program

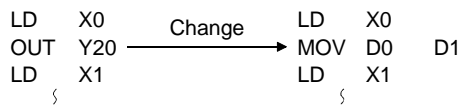

(2) Interlock with the ladder monitor function (only when A985/97*/960GOT is used)

The list edit window can be started from the ladder monitor screen with a single touch. The list can be edited while viewing the ladder.

The list can also be displayed from the step line displayed on the ladder monitor.

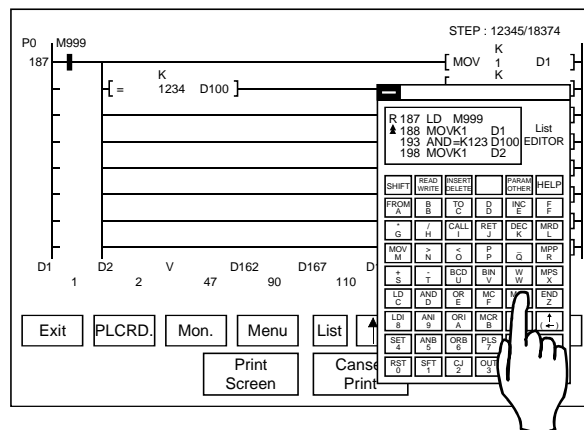

(3) The list edit screen can be recorded.

The hard copy function allows recording the edit screen of the list program.

(4) Access to other station is available.

The sequence program of the PLC CPU in other station can be list edited.

(5) Useful help functions

Help functions for read, write, insert and delete are available on the interactive menu selection system. Simple operation is facilitated.

(6) Comment for each device can be displayed.

Comment of the device at the cursor position can be displayed.



1.1.7 Features of the motion monitor function

Installation of the motion monitor function OS or downloading of motion monitor data into the built-in memory of the GOT using GT Designer enables the servo monitoring and parameter setting of the motion controller CPU (Q172CPU, Q173CPU). The following are the features of the motion monitor function.

(1) Various servo monitor data can be displayed on multiple monitor screens (refer to Section 23.3 for details)

The motion monitor function has multiple monitor screens, on which you can monitor servo data in a variety of patterns.

(Display examples)

Present Value Monitor

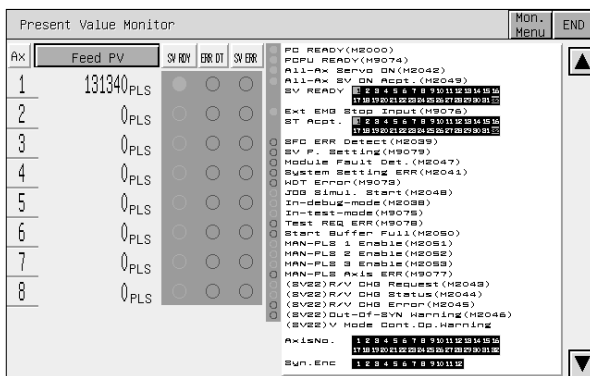

- Monitors and displays the feed current values and actual current values of all running axes. (Refer to Section 23.3.3)

Error List

M/ D	H: M	AX	SV No.	Err Code	Error Definition	Set Data
7/24				SV P		
10:50			103	906	The unused axis was started.	906
7/24				Maj.	At a start, sv.app. is OFF, initial processing, the app. is not yet installed, a sv.err. occurred, or the cable is faulty.	
10:50		5	20	1004		
7/24				SV P		
10:50			21	4	Demand speed outside the range	4
7/24				SV P		
10:50			22	906	The unused axis was started.	906
7/24				SV P		
10:50			103	906	The unused axis was started.	906
7/24				Maj.	At a start, sv.app. is OFF, initial processing, the app. is not yet installed, a sv.err. occurred, or the cable is faulty.	
10:51		5	20	1004		
7/24				SV P		
10:51			21	4	Demand speed outside the range	4
7/24				SV P		
10:51			22	906	The unused axis was started.	906

- Displays the history of errors that occurred on and after the leading edge of PLC ready (M2000). (Refer to Section 23.3.3)

Positioning Monitor

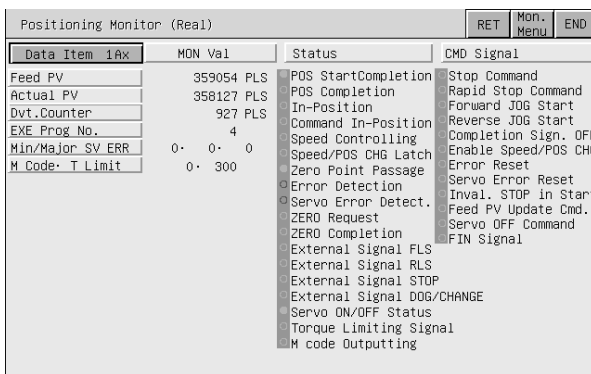

- Monitors the details of the positioning data set to any axis. (Refer to Section 23.3.5)

Error List Designated-Axis

1Ax	Err Code	Error Definition
Min.ERR	204	PC ready/M2000 turned from OFF to ON again during deceleration made by PC ready/M2000 OFF.
Maj.ERR	0	
SV ERR	0	
Program No.	[0]	
R/V CHG ERR Info(H)	0000	
PC Link COM ERR	0	
Motion CPU WDT ERR	0	
MAN-PLS Axis ERR	Each 1-Pulse	1 2 3 4 5 6 7 8 9 10 11 12 13 14 15 16
IM Error		17 18 19 20 21 22 23 24 25 26 27 28 29 30 31 32
MAN-PLS AX ERR		1 2 3
Each MAN-PLS SM ERR		1 2 3
Test REQ ERR	Op. Axis No. By Test Mode Req.	1 2 3 4 5 6 7 8 9 10 11 12 13 14 15 16 17 18 19 20 21 22 23 24 25 26 27 28 29 30 31 32

- Displays the latest errors that occurred on the specified axis. (Refer to Section 23.3.4)

(2) Servo parameters can be set by write operation (refer to Section 23.4 for details)

(Write example: Making the auto tuning function invalid)

Parameter setting screen

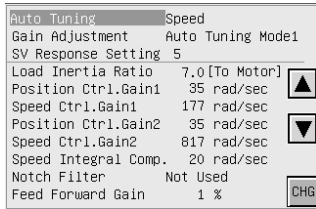

Parameter setting window appears

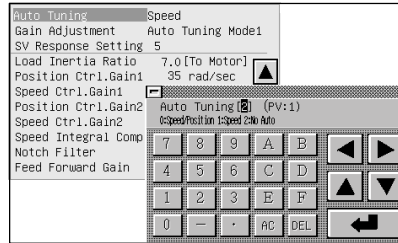

Change auto tuning from "1" to "2"
(No Auto).

Parameter setting screen

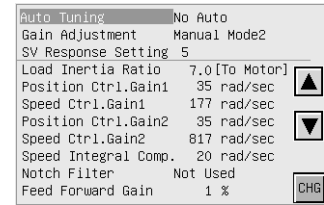

Parameter setting is changed.

- 1) By performing write operation from the parameter setting screen, write the servo parameter setting (basic parameters/adjustment parameters) to the motion controller CPU.
- 2) When changing any servo parameter setting, enter the necessary numeral or option number from the automatically displayed key window to change the servo parameter setting, and write it to the motion controller CPU.

1.1.8 Features of the servo amplifier monitor functions

You can perform various monitor functions, parameter setting changes, test operations and others for the servo amplifier connected to the GOT.
The features of the servo amplifier monitor functions are described below.

- (1) Servo amplifier status is displayed in real time
(detailed description: Section 26.4, Section 26.5)

The status and alarm definition of the servo amplifier connected to the GOT can be listed in real time.
(Display example: A975GOT)

Monitor

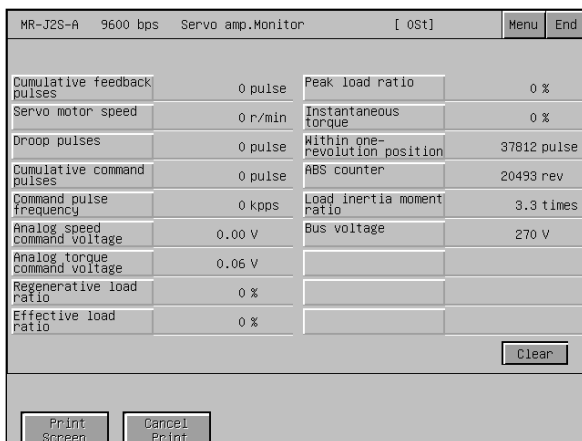

- Lists the monitor data of the servo amplifier. (Refer to Section 26.4.1.)

Alarm display

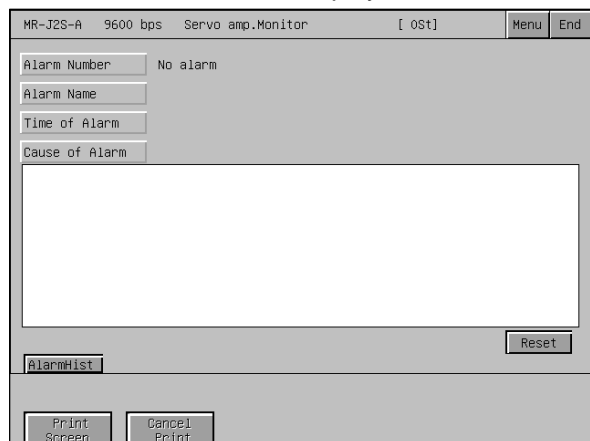

- Displays the definition (number, name, occurrence time, occurrence factor) of the alarm currently occurring in the servo amplifier. It also allows the alarm to be reset. (Refer to Section 26.5.1.)

- (2) Various diagnostics can be run on the servo amplifier
(detailed description: Section 26.6)

There are multiple diagnostic functions to run various diagnostics on the connected servo amplifier.
(Display example)

DI/DO display

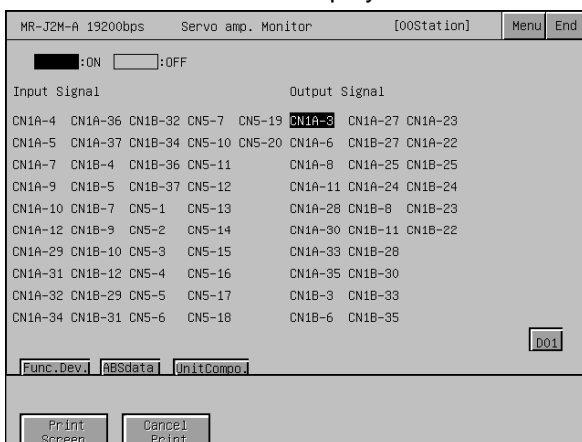

- Lists the ON/OFF states of the external I/O signals of the servo amplifier. (Refer to Section 26.6.1.)

Amplifier information display



- Displays the software number of the servo amplifier and the information (model, ID, encoder resolution) of the servo motor. (Refer to Section 26.6.3.)

- (3) Servo parameters can be written (detailed description: Section 26.7)
The parameter values of the servo amplifier can be read, changed and written to the servo amplifier.

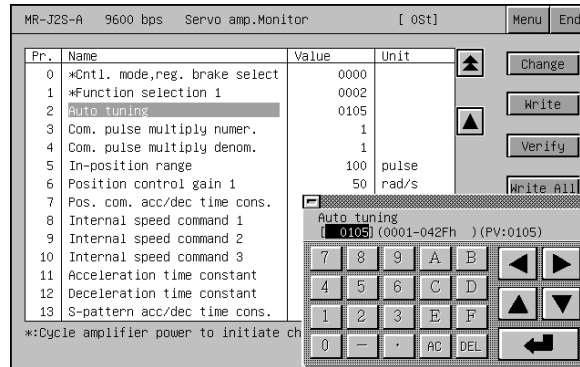

- (4) Various test operations can be performed (detailed description: Section 26.8)
Various test operations can be performed for the connected servo amplifier.
(Display example)

JOG operation

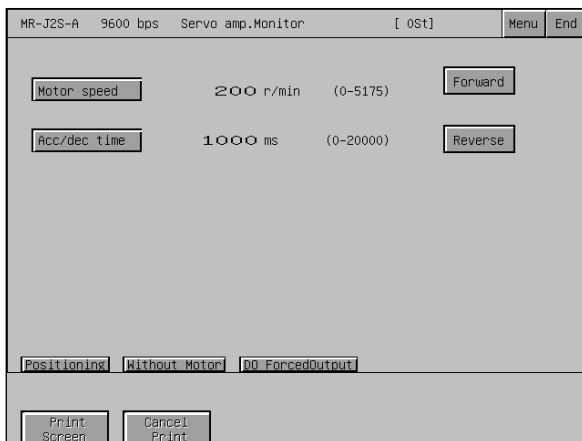

- While the Forward/Reverse key is touched, the servo amplifier runs. (Refer to Section 26.8.3.)

Motorless operation

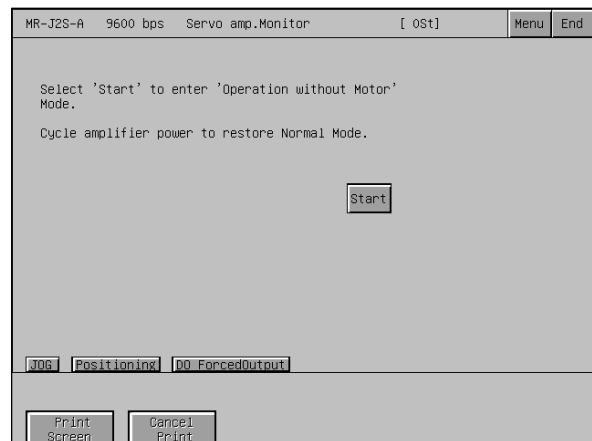

- Simulates the operation of the servo motor in the servo amplifier if the servo motor is not connected. (Refer to Section 26.8.5.)

CHAPTER2 BEFORE BEGINNING OPERATION

The required equipment for using the monitor functions in this manual are described in this section.

2.1 Before getting started with various functions

To use in this manual, such as the utility function, ladder monitor function, system monitor function, special module monitor function, network monitor function, motion monitor function and servo amplifier monitor function, an operating system (OS) for each function must be installed first on your GOT by using GT Designer. To install an OS for your desired function on your GOT, see GT Works Version5/GT Designer Version5 Reference Manual.

2.2 Required equipment

The chart below shows the equipment required for using the monitor functions.

○: Required ×: Not required

Required equipment	Application	Utility function	Ladder monitor function	System monitor function	Special function module monitor function	Network monitor function	List editor function	Motion monitor function	Servo amplifier monitor function	
GOT main unit (A95*GOT- *BD-M3)	<ul style="list-style-type: none"> It is required to use the option function installed on the A95*GOT. 	×	×	×	×	○	○	○	○	
Memory board *1	<ul style="list-style-type: none"> Needed to execute the option functions installed in the GOT. 		A985/97*/960 GOT		○					○
	A956WGOT		○*3		×					×
PLC GT Designer *2	<ul style="list-style-type: none"> Required for installing the object monitor function OS into the GOT and downloading the special module monitor data. It is necessary to install the GT Designer into the PLC. 				○				○	
Connecting cables *2	<ul style="list-style-type: none"> Required for connecting the above PLC and the GOT when installing the object monitor function OS into the GOT and downloading the special module monitor data. 				○				○	

*1 The table below shows the types of memory boards available for using the option functions. To use the ladder monitor function requires the memory board compatible with the PLC CPU to be monitored.

Name	Model	Contents
Memory board for option functions	A9GT-FNB	For option function (applicable for MELSEC-A/FX ladder monitor)
	A9GT-QFNB	For option function (applicable for MELSEC-Q/QnA/A/FX ladder monitor)
Expanded memory board for option functions	A9GT-FNB1M	Option function (applicable for MELSEC-A/FX ladder monitor) + internal memory extension 1MB
	A9GT-FNB2M	Option function (applicable for MELSEC-A/FX ladder monitor) + internal memory extension 2MB
	A9GT-FNB4M	Option function (applicable for MELSEC-A/FX ladder monitor) + internal memory extension 4MB
	A9GT-FNB8M	Option function (applicable for MELSEC-A/FX ladder monitor) + internal memory extension 8MB
	A9GT-QFNB4M	Option function (applicable for MELSEC-Q/QnA/A/FX ladder monitor) + internal memory extension 4MB
	A9GT-QFNB8M	Option function (applicable for MELSEC-Q/QnA/A/FX ladder monitor) + internal memory extension 8MB

*2 For information about the PLC on which to install and use GT Designer and the cable to be connected between the PLC and the GOT, see GT Works Version5/GT Designer Version5 Reference Manual.

*3 Only MELSEC-Q ladder monitor may be used.

2.3 Precautions before use

Precautions before using each function are described as follows:

(1) There are unavailable functions depending on the GOT.

Function category	Function	A985GOT A97*GOT A960GOT	A956WGOT	A95*GOT	GT SoftGOT
Basic function	Utility function	○	○	○	○
Extension function	System monitor function	○	○	○	× ^{*2}
Option function	Ladder monitor function	○ (Memory board required*1)	○ (Memory board required*1, *3)	×	× ^{*2}
	Special unit monitor function	○ (Memory board required*1)	×	×	× ^{*2}
	Network monitor function	○ (Memory board required*1)	○ (Memory board required*1)	○ (Use A95*GOT- *BD-M3)	× ^{*2}
	List editor function	○ (Memory board required*1)	○ (Memory board required*1)	○ (Use A95*GOT- *BD-M3)	× ^{*2}
	Motion monitor function	○ (Memory board required*1)	○ (Memory board required*1)	○ ^{*4} (Use A95*GOT- *BD-M3)	×
	Servo amplifier monitor function	○ (Memory board required*1)	○ (Memory board required*1)	○ ^{*4} (Use A95*GOT- *BD-M3)	×

*1 Refer to Section 2.2 for details of the memory board designed to perform the option functions.

*2 Using GT SoftGOT and GX Developer on the same personal computer enables the equivalent functions to be performed.

*3 Only MELSEC-Q ladder monitor may be used.

*4 Unusable for Present Value History Monitor.

(2) Note that some functions are unavailable depending on the connection target CPU and connection form. There are the following restrictions on each function depending on the connection target CPU and connection form.

Refer to Chapter 2 of the GOT-A900 Series User's Manual (GT Works Version5/GT Designer Version5 compatible Connection System Manual) for the connectable CPU names and the access range for monitoring per connection form.

(a) Connection with QCPU (Q mode)

BT13 : Indicates that the A8GT-J61BT13 is used (intelligent device station).

BT15 : Indicates that the A8GT-J61BT15 is used (remote device station).

G4 : Indicates that the A9GT-RS4 or A9GT-50WRS4 is used (via G4).

○: Usable △: Partly restricted ×: Unusable

Functions			Ref. Section	QCPU(Q Mode)								
				Bus connection	CPU direct connection	Computer link connection	MELSEC NET connection	CC-Link connection			Ethernet connection	
							BT13	BT15	G4			
Utility function			Section 4		○		△ ⁺¹	○	△ ⁺²	○	○	
Ladder monitor function	Ladder monitor	Sequence program monitoring using ladder signals	Section 6.3.1									
	Display switching	Decimal and hexadecimal display of word device values	Section 6.3.3	○			×	△ ⁺⁶	×	○	○	
		Device comment display										
	Device changing	Changing of device values	Section 6.3.4				×	△ ⁺⁶	×	○	○	
Print out	Printing of ladder	Section 6.3.5										
System monitor function	Entry monitor	Monitoring of current values by pre-registering monitor devices	Section 9.2									
	Batch monitor	Monitoring of n points of current values subsequent to specified device	Section 9.3				×	○	△ ⁺³	○	○	
	T/C monitor	Monitoring of m points of current values, set values, contact points, and coils subsequent to specified device	Section 9.4		△ ⁺⁹		×	△ ⁺⁴	×	○	○	
	BM monitor	Monitoring of x points of current values subsequent to specified buffer memory of specified special module	Section 9.5		△ ⁺⁹		×	○	×	○	○	
	Data editing using test operation	Setting/resetting of bit device		Section 9.6		○		×	○	×	○	○
		Changing of current value for buffer memory of word device			○		△ ⁺⁵	×	○	×	○	○
		Changing of current value for T/C (can be used while monitoring T/C)			○			×	○	×	○	○
		Changing of set value for T/C (can be used while monitoring T/C)			○			×	△ ⁺⁶	×	○	○
	Quick test	Changing of device values using quick test	Section 9.6.2		○		×		○		○	
	Display switching	Device comment display		Section 9.1.2		○		×	△ ⁺⁶	×	○	○
Decimal and hexadecimal display of word device values and buffer memory values			○				×		○		○	
Special module monitor function	Monitoring of buffer memory of special module on special screen	Ch. 11		○			○	×	○	○		
Network monitor function	Monitoring of network status of MELSECNET/B, (II) or /10	Ch. 15					○					
List editor function	Sequence program in the ACPU is list edited.	Ch. 19					×					
Motion monitor function	Servo monitor	Monitoring of servo-related items, such as current values and positioning errors, on various monitor screens.	Ch. 22		△ ⁺⁸				×			
	Parameter setting	Changing of servo parameter values.										
Servo amplifier monitor function	Servo amplifier monitor, servo parameter setting change, test operation.	Ch. 25					○					

*1 Clock setting cannot be used when the connection target CPU is the Q00JCPU, Q00CPU or Q01CPU for MELSECNET/10 connection.

*2 Clock setting cannot be used when the A8GT-J61BT13 is used (intelligent device station).

*3 When the A8GT-J61BT15 is used (in the remote device station), only the link devices assigned to the GOT can be monitored.

*4 The T/C set values cannot be monitored if the software version of the A8GT-J61BT13 used is version W or earlier.

*5 Can't change V or Z current values.

*6 Cannot be monitored if the software version of the A8GT-J61BT13 used is version W or earlier.

*7 If you modified the set value for T/C using the ladder monitor test function, you need to repeat the PC readout procedure to enable the display of the modification.

*8 The target CPUs of the motion monitor function are only the Q172CPU and Q173CPU.

*9 Cannot be monitored when the Q172CPU or Q173CPU is monitored.

(b) Connection with QnACPU or ACPU / QCPU (A mode)

○: Usable △: Partly restricted ×: Unusable

Functions			Ref. Section	QnACPU						ACPU / QCPU (A mode)							
				Bus connection	CPU direct connection	Computer link connection	MELSEC NET connection	CC-Link connection	Ethernet connection	Bus connection	CPU direct connection	Computer link connection	MELSEC NET connection	CC-Link connection	Ethernet connection		
Utility function			Ch. 4	○						○							
Ladder monitor function	Ladder monitor	Sequence program monitoring using ladder signals	Section 6.3.1				○										
	Display switching	Decimal and hexadecimal display of word device values	Section 6.3.3	○			×	△ ^{*2}	○	○		△ ^{*1}	○	△ ^{*2}	○		
		Device comment display															
	Device changing	Changing of device values	Section 6.3.4	○			×	△ ^{*2}	○					△ ^{*2}	○		
Print out	Printing of ladder	Section 6.3.5								○							
System monitor function	Entry monitor	Monitoring of current values by pre-registering monitor devices	Section 9.2	○			×	△ ^{*3}	○					△ ^{*3}	○		
	Batch monitor	Monitoring of n points of current values subsequent to specified device	Section 9.3	○			×	△ ^{*3}	○					△ ^{*3}	○		
	T/C monitor	Monitoring of m points of current values, set values, contact points, and coils subsequent to specified device	Section 9.4														
	BM monitor	Monitoring of x points of current values subsequent to specified buffer memory of specified special module	Section 9.5	○			×	△ ^{*2}	○					△ ^{*2}	○		
	Data editing using test operation	Setting/resetting of bit device															
		Changing of current value for buffer memory of word device		○		△ ^{*5}	×	△ ^{*2}	○	○		△ ^{*5}	○	△ ^{*2}	○		
		Changing of current value for T/C (can be used while monitoring T/C)		○			×	△ ^{*2}	○		○			△ ^{*2}	○		
	Quick test	Changing of set value for T/C (can be used while monitoring T/C)		○			×	△ ^{*2}	○	○		×	○	△ ^{*2}	○		
		Changing of device values using quick test	Section 9.6.2	○			×	○	○		○			○	○		
	Display switching	Device comment display		○			×	△ ^{*2}	○					△ ^{*2}	○		
Decimal and hexadecimal display of word device values and buffer memory values		Section 9.1.2	○			×	○	○					○	○			
Special module monitor function	Monitoring of buffer memory of special module on special screen	Ch. 11	○			×	△ ^{*2}	○	○		×	○	△ ^{*2}	○			
Network monitor function	Monitoring of network status of MELSECNET/B, (II) or /10	Ch. 15	○			×	△ ^{*2}	○		○		△ ^{*7}	△ ^{*2}	○			
List editor function	Sequence program in the ACPU is list edited.	Ch. 19				×			△ ^{*8}	○	×		△ ^{*8}				
Motion monitor function	Servo monitor	Monitoring of servo-related items, such as current values and positioning errors, on various monitor screens.	Ch. 22				×										
	Parameter setting	Changing of servo parameter values.															
Servo amplifier monitor function	Servo amplifier monitor, servo parameter setting change, test operation.	Ch. 25							○								

*1 Subprograms 2, 3 of the A4UCPU (for computer link connection) cannot be monitored.

*2 Can be monitored only when the A8GT-J61BT13 is used (in the intelligent device station).

*3 When the A8GT-J61BT15 is used (in the remote device station), only the link devices assigned to the GOT can be monitored.

*4 Can't monitor T/C set values.

*5 Can't change V or Z current values.

*6 If you modified the set value for T/C using the ladder monitor test function, you need to repeat the PC readout procedure to enable the display of the modification.

*7 Monitor is disabled when the connection target CPU is the AnU type (MELSECNET/10 network card is fitted).

*8 Program write is disabled when the connection target is the ACPU and E²PROM operation is being performed.

(c) Connection with FXCPU, third party PLC or microcomputer

○: Usable △: Partly restricted ×: Unusable

Functions		Ref. Section	FXCPU	Other PLC connection	Microcomputer connection	
			CPU direct connection			
Utility function		Ch. 4	△ ^{*1}	△ ^{*2}	△ ^{*3}	
Ladder monitor function	Ladder monitor	Sequence program monitoring using ladder signals	Section 6.3.1			
	Display switching	Decimal and hexadecimal display of word device values	Section 6.3.3	○	×	
		Device comment display	Section 6.3.4			
	Device changing	Changing of device values	Section 6.3.5			
Print out	Printing of ladder	Section 6.3.5				
System monitor function	Entry monitor	Monitoring of current values by pre-registering monitor devices	Section 9.2	○	×	×
	Batch monitor	Monitoring of n points of current values subsequent to specified device	Section 9.3		×	×
	T/C monitor	Monitoring of m points of current values, set values, contact points, and coils subsequent to specified device	Section 9.4	△ ^{*4}	×	×
	BM monitor	Monitoring of x points of current values subsequent to specified buffer memory of specified special module	Section 9.5	×	×	×
	Data editing using test operation	Setting/resetting of bit device	Section 9.6	○	×	×
		Changing of current value for buffer memory of word device				
		Changing of current value for T/C (can be used while monitoring T/C)				
	Quick test	Changing of set value for T/C (can be used while monitoring T/C)	Section 9.6.2	×	×	×
Changing of device values using quick test						
Display switching	Device comment display	Section 9.1.2	×	×	×	
	Decimal and hexadecimal display of word device values and buffer memory values					
Special module monitor function	Monitoring of buffer memory of special module on special screen	Ch. 11	×	×	×	
Network monitor function	Monitoring of network status of MELSECNET/B, (II) or /10	Ch. 15	×	×	×	
List editor function	Sequence program in the ACPU is list edited.	Ch. 19	×	×	×	
Motion monitor function	Servo monitor	Monitoring of servo-related items, such as current values and positioning errors, on various monitor screens.	Ch. 22	×	×	
	Parameter setting	Changing of servo parameter values.				
Servo amplifier monitor function	Servo amplifier monitor, servo parameter setting change, test operation.	Ch. 25		○		

*1 Clock setting cannot be made when the GOT is connected with the PLC CPU that does not have the clock function (FX0, FX0N, FX1, FX2NC, FX0S).

The FX2 and FX2C allows clock setting to be made only when the cassette for real-time clock is used.

*2 Clock setting cannot be made when the GOT is connected with the PLC CPU that does not have the clock function.

*3 You can set the clock function only when you are using A9GT-RS2T, which includes a clock element.

*4 T/C set values and coils cannot be monitored.

(3) If a system program (OS) for the expanded or option functions has been installed, the following space is required in the GOT built-in internal memory to store user-created monitor screen data. Hence, add the memory board as required. Hence, installing the extended function OS into the GOT decreases the memory space (for monitor screen data storage) available for the user. If the free space is insufficient, fit the extension memory board to increase the memory space.

(a) List of extended function and option function OSs installed

Expanded Function OS Name		Space Necessary for Installation in Terms of Memory Count	Remarks
System monitor		1	—
Ladder monitor	MELSEC-A ladder monitor	1	Only one may be installed.
	MELSEC-QnA ladder monitor *1	2	
	MELSEC-Q ladder monitor *1	2	
	MELSEC-FX ladder monitor	1	
Motion monitor *1		2	—
Special module, recipe, sound		1	—
Network monitor		1	—
List editor (MELSEC-A) *1		2	—
Gateway *1		2	—
Servo amplifier Monitor *1		2	—
Others	ESC printer, bar code, report, CSV file, external key input	1	Only one may be installed.
	PCL printer, bar code, report, CSV file, external key input	1	
	ESC printer, bar code, report, CSV file, proximity I/O	1	
	PCL printer, bar code, report, CSV file, proximity I/O	1	
	ESC printer, bar code, report, CSV file, video/RGB input	1	
	PCL printer, bar code, report, CSV file, video/RGB input	1	
	Chinese (Big 5) printer, bar code, report, CSV file, external key input	1	
	Chinese (Big 5) printer, bar code, report, CSV file, proximity I/O	1	
	Chinese (Big 5) printer, bar code, report, CSV file, video/RGB input	1	
	Chinese (GB) printer, bar code, report, CSV file, external key input	1	
	Chinese (GB) printer, bar code, report, CSV file, proximity I/O	1	
	Chinese (GB) printer, bar code, report, CSV file, video/RGB input	1	

*1 When installed into the GOT, this OS uses the memory space twice larger than that of the other extended function OS.

*2 Install the "Other" extended function OSs when using the following functions.

- Report function
- Barcode function
- External I/O function
- Operation panel function
- Video display function
- When object function is used to create CSV format files
- Printer function
- RGB display

For this extended function OS, refer to the following 1) and 2) and select the OS that meets the language to be output to the printer or CSV file and the optional device used.

1) Language to be output to the printer connected to the GOT or the CSV file (alarm history display function, recipe function)

- ESC printer : Output in Japanese
- PCL printer : Output in English
- Chinese (Big 5) printer : Output in Chinese (traditional language)
- Chinese (GB) printer : Output in Chinese (simplified language)

2) Used optional device

- External key input : Operation panel, ten-key panel (operation panel function)
- Proximity I/O : External I/O device (external I/O function)
- Video/RGB input : Video camera (video display function), personal computer (RGB display function)

(b) Number of extended function OSs installed and free space of GOT's built-in memory

Number of Extended functions OSs	Memory Space Used [k bytes]	Free Space (User area) [k bytes] ^{*1}
0	0	1152
1	256	896
2	384	768
3	640	512
4	768	384
5	1024	128
6	1152	0

*1 Since the A95*GOT-*BD-M3 has the built-in memory of 3200k bytes, the free space is the above value plus 2048k bytes.

POINT

Using the special module monitor/motion monitor/servo amplifier monitor function requires the built-in memory to have enough memory space to store the special module monitoring data/motion monitor, servo amplifier monitor screens. (Refer to Sections 3.3.3, 3.6.4 and 3.7.5.)

CHAPTER3 SPECIFICATIONS

In this chapter, the specifications of the ladder monitor function, system monitor function, special module monitor function, list editor function, motion monitor function and servo amplifier monitor are discussed separately.

3.1 Ladder monitor function specifications

POINTS	Refer to Section 2.3 for restrictions on the ladder monitor function.
--------	---

3

3.1.1 PLC CPUs to be monitored

The PLC CPUs that allow ladder monitoring are the QCPU, QnACPU, ACPU, FXCPU and motion controller CPU (Except Q172CPU and Q173CPU). For details, refer to Section 2.3 (2).

3.1.2 Access ranges to be monitored

For access range for the ladder monitor function, see GOT-A900 Series User's manual (GT Works Version5/GT Designer Version5 compatible Connection system manual).

POINT	<ul style="list-style-type: none"> • When the capacity of parameter, PLC program, TC setting value, comment and extension comment is 144 kbytes or more, the comment will not be properly displayed. • The local device cannot be monitored on the QCPU(Q mode), QnACPU.
-------	--

3.2 System monitor function specifications

POINT	Refer to Section 2.3 for restrictions on the system monitor function.
-------	---

3.2.1 PLC CPUs to be monitored

The PLC CPUs that allow system monitoring are the QCPU, QnACPU, ACPU, FXCPU and motion controller CPU. For details, refer to Section 2.3 (2).

3.2.2 Access ranges to be monitored

For access range for the system monitor function, see GOT-A900 Series User's manual (GT Works Version5/GT Designer Version5 compatible Connection system manual).

3.2.3 Names of devices to be monitored

For the names of devices that can be monitored with the system monitor function, see GOT-A900 Series User's manual (GT Works Version5/GT Designer Version5 compatible Connection system manual).

3.2.4 Precautions when using the system monitor function

The precautions to follow when using the system monitor function are shown below.

(1) Monitor and test of real number data

Real number data cannot be monitored or tested.

Monitoring of word devices that save real number data is all done by integer data (binary data).

(2) Monitoring in 32-bit modules

When monitoring word devices (such as T, C, D, W) in 32-bit (2-word) modules, monitor up to the point where 32 bits remain in the monitor processing. A location where 16 bits (1 word) remain cannot be monitored.

This situation occurs when an odd number has been specified as the initial number in the monitor device.

(Example) When monitoring the A2NCPU data register in 32-bit modules beginning with an odd number (D1, D3...)

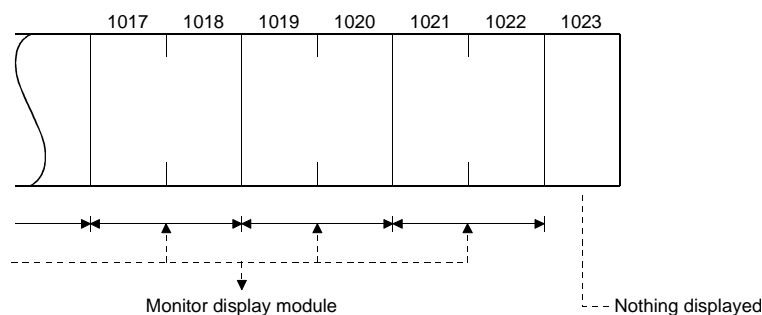

- (3) The "Date" column of a Rated Plate shows the date manufactured and function version number. If it reads "9707 B" or a later notation, timer/counter settings can be changed and device comments can be displayed when using any of the large-scale QnACPU or small-scale QnACPU.
- When changing the timer/counter setup value and performing the device comment display, use the CPU that is described above.

<Viewing the Rated Plate>

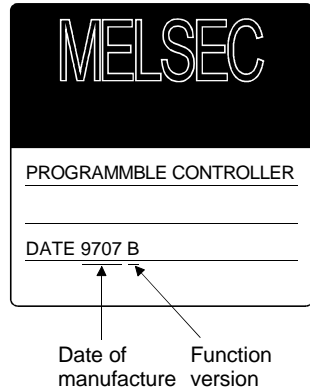

- (4) Only the main program may be used to change the timer/counter set values on the AnNCPU, AnACPU and AnUCPU.
- (5) Only the program of the file name displayed on the T/C monitor screen may be used to change the timer/counter set values on the QnA and QCPU (Q mode). Refer to Section 9.4.2 for details.

3.3 Special module monitor function specifications

POINTS	Refer to Section 2.3 for restrictions on the special unit monitor.
--------	--

3.3.1 Access ranges to be monitored

- (1) When using bus connection/CPU direct connection/computer link connection
 - The special function modules on the bases of the connected station and other stations can be monitored.
 - Special module monitoring for computer link connection is enabled for the systems of the following combinations.

PLC CPU used	Computer link/serial communication module used
QCPU (Q mode)	QJ71C24
QCPU (A mode)	A1SJ71UC24
QCPU (A mode)	AJ71QC24, A1SJ71QC24
QCPU (A mode)	AJ71UC24, A1SJ71UC24

- (2) When using MELSECNET(II) connection/MELSECNET/B connection
 - The special function module on the base of the master station can be monitored. (Cannot be monitored when the master station is the QnACPU.)
 - The special function modules on the bases of local stations cannot be monitored.
 - In a system configuration having remote I/O stations, special function modules cannot be monitored.
- (3) When using MELSECNET/10 connection
 - The special function modules on the bases of the control station and normal stations can be monitored. (Cannot be monitored when the stations are the QnACPU.)
 - In a system configuration having remote I/O stations, special function modules cannot be monitored.
- (4) When using CC-Link connection (remote device station)
 - The special function modules cannot be monitored.
- (5) When using CC-Link connection (intelligent device station / via G4)
 - The special function modules on the bases of the master and local stations can be monitored.
 - In a system configuration having remote I/O stations, special function modules cannot be monitored.
- (6) When using Ethernet connection

The special function module on the base of the PLC CPU assigned the IP address can be monitored.
(The station assigned in the Ethernet setting of GT Designer can be monitored.)

3.3.2 Special function modules to be monitored

The modules for which special function monitoring can be done are only those types shown in Section 3.3.3.
Monitoring of special function modules other than those can be done with the system monitor function "BM Monitor".

3.3.3 Required memory spaces for use of special module monitor function

The following table indicates memory spaces for special module monitor data. The memory spaces required for storing data into the internal memory of the GOT is the same as the memory spaces required for storing data into the hard disk of a personal computer.

For QCPU(A mode), QnACPU, ACPU		For QCPU(Q mode)	
Stored data	Memory space [k bytes]	Stored data	Memory space [k bytes]
Special module monitor data common information	13.4	Special module monitor data common information	13.4
A61LS	14.5	Q64AD	18.2
AD61	8.14	Q68ADV	
A62DA-S1	6.91	Q68ADI	
A62LS	69.8	Q62DA	12.9
A68AD(S2)	9.97	Q64DA	
A68ADN	15	QD62	16.2
A68RD3	17.8	QD62E	
A68RD4		QD62D	
A616AD	123	QD75P	313.5
A616DAI	33.5 *3	QD75D	
A616DAV			QD75M
A616TD	230	Input module	0.0
AD70	20.5	Output module	0.0
AD70D	29.3	—	—
AD71(S1/S2/S7)	546	—	—
AD72	562	—	—
A1SD71-S2(S7)			—
AD75P1(P2/P3) *1	520 *3	—	—
A1SD75P1(P2/P3) *2			—
AJ71PT32-S3	43.5	—	—
AJ71ID1(ID2)-R4	40.5	—	—
A1SJ71ID1(ID2)-R4			—
A84AD	20.2	—	—
A1SD61	36.9	—	—
A1S62DA	5.12	—	—
A1S62RD	12.5	—	—
A1S63ADA	16.4	—	—
A1S64AD	12.3	—	—
A1S68AD	9.75	—	—
A1S68DAI	25.8*3	—	—
A1S68DAV			—
A1SD70	21.1	—	—
A1SJ71JP132-S3	43.2	—	—
A1S64TCTT/RT-S1	45.7	—	—
Input module	0.0	—	—
Output module	0.0	—	—

*1: The AD75M1(M2/M3) can be monitored within the range of the AD75P1(P2/P3).
 *2: The A1SD75M1(M2/M3) can be monitored within the range of the A1SD75P1(P2/P3).
 *3: Downloading either data enables both special function modules to be monitored.

3.3.4 Precautions when using the special module monitor function

The precautions to follow when using the special module monitor function are discussed below.

(1) Special function modules that cannot be monitored

Modules displayed as "special" on the system configuration screen cannot be monitored using the special module monitor function.

To monitor these modules, use the system monitor function "BM Monitor".

(2) Display when connecting the small building-block type PLC CPU

This precaution pertains to a situation where an expansion base unit for a large building block type of setup is connected to a small building-block type CPU (such as the A1SCPU) in a station connected to the GOT.

In such a case, the special function module on the large expansion base unit is displayed on the system configuration screen with the same model name as that of the small building-block type special function module.

If there is no small building-block type special function module, "special" is displayed and the object module cannot be monitored.

(Example)

[Module Model]	[Model Name Displayed]
AD72	→ A1SD71
AJ711D	→ A1SJ711D
AJ71PT32-S3	→ A1SJ71PT32-S3
AD75P	→ A1SD75P
A68AND [CH1 to CH8]	→ A1S64AD [CH1 to CH4]
A68RD [CH1 to CH8]	→ A1S62RD [CH1 to CH4]

(3) Monitoring restricted special function modules

(a) When monitoring the AD71 (S1, S2, S7)

When the slot on front of the AD71 module is an empty slot, monitoring is done in the following way.

1) The AD71 is treated as the AD72, and "AD72" is displayed on the system configuration screen.

In this case, when monitoring the AD71, select the AD72 in the object display position.

2) The monitor screen that is displayed by 1) above is for the AD72.

The number obtained by subtracting 10H from the I/O signal number on the display is the number to be used when installing the AD71 in the 0 slot.

* If you do not want the AD1 to be treated as the AD72, execute "Shift the installation position of AD71 forward" or "In the I/O assignments, assign the empty slot in front of AD71 to the 16 X-Y points."

- (b) When monitoring the A68AD, A68ADN or A68RD used with a small building block type PLC CPU

A special function module installed in a large building block type extension base unit connected to a small building block type PLC CPU (e.g. A1SCPU) is recognized and monitor-processed by the GOT as a small building block type special function module. Hence, there are the following instructions for use of the A68AD, A68ADN and A68RD.

Special function module	Instruction
A68AD	The A68AD cannot be displayed correctly because of the buffer memory map differences between the A68AD and A1S68AD.
A68ADN	Among CH1 to CH8 of the A68ADN, CH5 to CH8 cannot be displayed since the A1S64AD has only CH1 to CH4.
A68RD	Among CH1 to CH8 of the A68RD, CH3 to CH8 cannot be displayed since the A1S62RD has only CH1 and CH2.

The above special function modules can be monitored properly if they are installed in a base unit connected to a large building block type PLC CPU (e.g. AnUCPU)

- (c) When monitoring the A1SD75M, AD75M

The A1SD75M/AD75M is displayed as A1SD75P/AD75P.

The A1SD75M/AD75M can be monitored within the monitoring range of the A1SD75P/AD75P.

- (d) When monitoring the A81CPU

The A81CPU is monitored in the following way.

	64 points in first half	64 points in last half
Treatment of A81CPU	Change to module that cannot be monitored.	Change to input module.
System configuration screen	Display "Special X, Y []"	Display "Input 64 X []"
Possibility of monitoring	Not possible	Can be monitored as input.

- (e) When monitoring an I/O composite module

- 1) With an I/O composite module for which "Output []" is displayed on the system configuration screen, only the output signal can be monitored. For the input signal, monitor X of the PLC CPU device with the system monitor function.

- (4) Editing and allocating of special module monitor data

Data displayed on a special module monitor screen cannot be edited by modifying or adding an object, except that the data can be used on a user-created monitor screen.

(5) Precaution for I/O allocation setting

(a) When the QnACPU is connected, the head XY numbers are displayed in due order on the special module monitoring system configuration screen if the I/O allocation setting is random as shown below.

When performing special module monitoring, always perform the I/O allocation in order from slot 0.

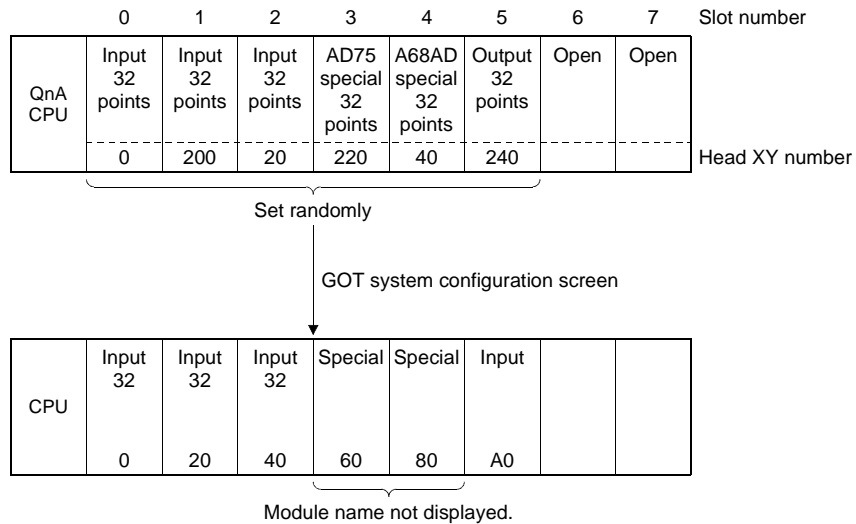

(b) If the slot assigned to Output in I/O allocation is not fitted with a module, the GOT displays Input. (Common to ACPUs and QnACPU)

(6) The system configuration including remote I/O stations cannot be monitored.

(7) Display provided when the QA1S6□ extension base unit is used with the QCPU(Q mode)

The following instruction is given for the case where the QA1S6□ extension base unit is connected to the QCPU(Q mode) which is a GOT-connected station. In this case, any of the following special function modules is displayed as the abbreviated formats on the system configuration screen.

You can use the Unit detail information to confirm the formal format of the module which was displayed as the abbreviated format.

Unsupported special function modules are displayed as "Special" and the corresponding modules cannot be monitored.

Loaded module	Displayed format
A1S63ADA	63ADA
A1SJ71PT32-S3	J71PT32-
A1SJ71ID1-R4	J71ID
A1SJ71ID2-R4-S1	
A1S64TCTT(BW)-S1	64TCTT/R
A1S64TCRT(BW)-S1	

3.4 Network monitor function specifications

POINTS	Refer to Section 2.3 for restrictions on the network monitor function.
--------	--

3.4.1 Network information to be monitored

The following table shows the types of network information that can be monitored.

Table 3.1 Network Information To be Monitored

Function		Network Information	MELSECNET (II)/B Master Station	MELSECNET (II)/B Local Station	MELSECNET /10 Control Station	MELSECNET /10 Ordinary Station	MELSECNET /10 Remote Master Station
Own station monitor		Network category display	○	○	○	○	○
		Network No. display	×	×	○	○	○
		Station No. display	○	○	○	○	○
		Own station operation mode	○	○	○	○	○
		Own station loop line status	○	○	○	○	○
		Loop back execution status	○	○	○	○	○
		Link scan time display	○	×	○	○	○
		Data link system loop status	○	×	○	○	○
	Own station communications status	×	○ ^{*1}	×	×	×	
Detailed own station monitor	Own station information	Own station's station No.	○	○	○	○	○
		Own station	○	○	×	×	×
		Network No.	×	×	○	○	○
		Group No.	×	×	○	○	×
	Control-station information	Specified control station	×	×	○	○	×
		Current control station	×	×	○	○	×
		Communications information	×	×	○	○	×
		Sub-control-station link	×	×	○	○	×
		Remote-I/O-master-station station No.	×	×	○	○	×
	Data link information	Total of linked stations	○	○	○	○	○
		Largest connected station	×	×	○	○	○
		Largest data-linked station	×	×	○	○	○
		Communications status	×	○	○	○	○
		Causes of interrupted communications	×	×	○	○	○
		Causes of data link stoppage	×	×	○	○	○
	Constant link scan	Constant link scan	×	×	○	○	○
	BWY receive	BWY from the master station	×	○	×	×	×
	BW receive	BW from the master station in the higher loop	×	○	×	×	×
	Loopback	F-loop status	○	○	○ ^{*2}	○ ^{*2}	○ ^{*2}
		R-loop status	○	○	○ ^{*2}	○ ^{*2}	○ ^{*2}
		F-loopback station	○	×	○ ^{*2}	○ ^{*2}	○ ^{*2}
		R-loopback station	○	×	○ ^{*2}	○ ^{*2}	○ ^{*2}
		Loop switching frequency	○	×	○ ^{*2}	○ ^{*2}	○ ^{*2}
	Own station status	Parameter settings	×	×	○	○	×
		Designation of reserved stations	×	×	○	○	○
		Communications mode	×	×	○	○	○
		Designation of transmission	×	×	○ ^{*2}	○ ^{*2}	○ ^{*2}
		Transmission status	×	×	○ ^{*2}	○ ^{*2}	○ ^{*2}
Other station monitor	Communications status of each station	○	×	○	○	○	
	Data link status of each station	○	×	○	○	○	
	Parameter status of each station	○	×	○	○	○	
	CPU action status of each station	○	○	○	○	×	
	CPU RUN status of each station	○	○	○	○	×	
	Loop status of each station	○	×	○ ^{*2}	○ ^{*2}	○ ^{*2}	

*1 Accessible only when connected to a MELSECNET(II) local station.

*2 Accessible only when connected to a MELSECNET/10 optical fiber cable.

○: Accessible ×: Not accessible

3.4.2 Access ranges to be monitored

For access range for monitoring, see Chapter 2 of the GOT-A900 Series User's manual (GT Works Version5/GT Designer Version5 compatible Connection system manual).

3.4.3 Precautions when using the network monitor function

The following describes precautions that should be followed when using the network monitor function.

- (1) When the GOT is connected to an AnNCPU or AnACPU, a screen display shows a screen of the MELSECNET II network even when you are connected to the MELSECNET/10 network (the monitor screen shows the display contents of the MELSECNET II).
- (2) There may be a possibility that the network monitor function cannot be used, depending on which CPU to connect and which connection method to use.

CPU to Be Connected	Connection Method	Network Monitor Function		
		Own Station Monitor	Detailed Own Station Monitor	Other Station Monitor
QCPU, QnACPU, ACPU, Motion controller cpu *3	Bus connection	○	○	○
	Direct CPU connection			
	MELSECNET connection *1			
	Computer link connection *2			
	CC-Link connection			
	Ethernet connection			
FXCPU	CPU direct connection	×	×	×
Other manufacture's PLC				

*1 When connected to a Q/QnACPU, control and master stations cannot be monitored.

*2 When connected to an AnUCPU, monitoring cannot be done with the MELSECNET/10 network card being installed.

*3 When the target CPU is the Q172CPU or Q173CPU, monitoring cannot be done.

- (3) When connected to a QnACPU and the master station of the MELSECNET(II), monitoring cannot be done with the keyword being defined.

3.5 List editor function specifications

POINTS	Refer to Section 2.3 for restrictions on the List editor function.
--------	--

3.5.1 PLC CPU that allows for list edit

PLC CPUs that allow list edit are either the QCPU(A mode) or the ACPU.
For details, refer to section 2.3 (2) (a).

POINT	<p>In using the A2USH-S1/A2SH-S1/A2SH/A1SH/A1SJHCPU, the following restrictions should be observed in the range of list edit.</p> <p>In using the A2USHCPU-S1 : In the range of the A3UCPU</p> <p>In using the A2SH-S1/A2SH/A1SH/A1SJHCPU : In the range of the A3NCPU</p>
-------	--

3.5.2 Access range that allows for list edit

For information about the access range that allows for list edit, see Chapter 2 of the GOT-A900 Series User's manual (GT Works Version5/GT Designer Version5 compatible Connection system manual).

3.5.3 Precautions for List editor function

Precautions for the List editor function are as follows:

- (1) Precaution for reading with the specified command
The command cannot be specified to read the ladder.
- (2) Precaution for use with the ladder monitor function
If list edit is performed while the ladder monitor function is started, the edit details are not shown on the ladder monitor screen.
To show the edit details, the ladder monitor must be read from the PLC again.
- (3) Precaution for list edit
While the corresponding PLC is at stop status, perform list edit.
The list cannot be edited during PLC running.
- (4) Precaution for parameter changing on the other peripheral device
If parameter settings are changed on the other peripheral device during use of the list edit function, they will be different from the settings of the internal parameters of the list edit function.
For this reason, reset the GOT unit or make PC No. setting again to read the parameters.
- (5) Precaution for Ethernet connection
To use the list editing function for Ethernet connection, the host setting on GT Designer must be preset to the ACPU or QCPU (A mode).

3.5.4 List of key arrangement and key functions

Key arrangement and key functions of the list edit window are shown below.

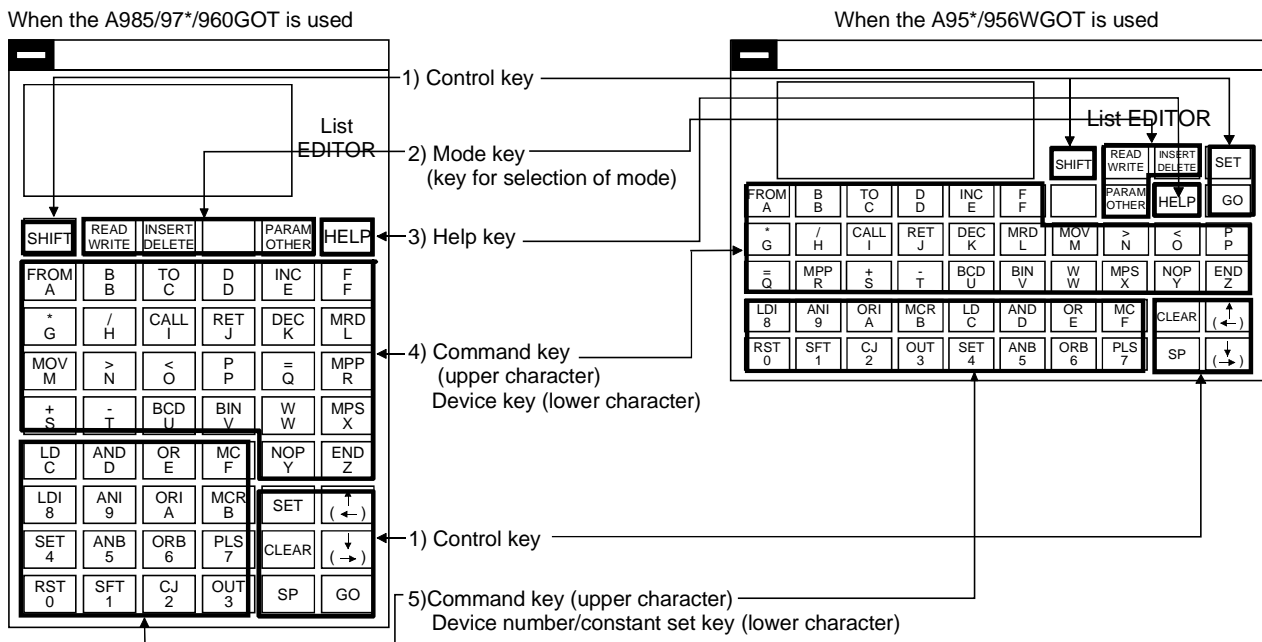

No.	Name	Key	General description of function
1)	Control key	SET	Key that declares start of step number input or automatic scroll. Switch key that makes the lower character valid on each key with dual functions. Whether upper or lower character is valid can be checked on the display.
		SHIFT	Switch key that makes the upper character valid on each key with dual functions. Whether upper or lower character is valid can be checked on the display.
		CLEAR	If the Clear key is pressed when the system is not in the Parameter mode, Other mode or Help function, the screen returns to the initial status of the mode selection. (The input commands or device numbers except for the mode are cleared.) This is used for repeating the procedure if incorrect keys are pressed.
			In the Parameter mode, the process is cancelled. After restarting, continue the operation.
			In the Other mode, the screen returns to the previous display.
		When the Help function is used, the screen returns to the display at the input of the HELP key.	
		SP	Key that provides blank space at the command and at between device names.
(←), (→)	Key that moves the cursor on the display (▶, ◼) or determines scroll directions.*		
2)	Mode key	READ WRITE to PARAM OTHER	Key that selects each mode of the List editor function. Switch the upper/lower character mode with the SHIFT key.
		HELP	Key that selects the help function in the mode supporting the help function.
4)	Command key Advice key	FROM A to END Z	Key that inputs K/H at the input of command, device name and constant input. Only when the valid key of upper/lower character needs to be switched, switching is allowed with input of the SHIFT and SET keys.
5)	Command key Device No./Constant setting key	RST 0 to MC F	Key that inputs the command, device number and constant. Only when the valid key of upper/lower character needs to be switched, switching is allowed with input of the SHIFT and SET keys.

* Movement of the cursor key between steps, between the menu items and in the input area is explained below.

(1) Keep pressing the cursor key to repeat the movement toward the specified key direction.

(2) Movement between steps and between menu items

To display the program immediately before/after the current step number command, Input either or key.

: Program immediately before the command (no change after 0 step)

: Program immediately after the command (no change after the last step)

R	0	L D	X 0 0 0 5
▲	1	A N D	M 2
	2	▶ O U T	T 0
	3	K 1 2 3	

"▶" moves to the specified direction (upward/downward) with or key.

(3) Movement in the input area

To move the cursor between command names, between sources, and between destinations, input either or key.

W	1 1 5	M 5	
▼	1 2 0	L D	M 3
	1 2 1	▶ N O P	
P	K 2 1 4 7 4 8 3 6 4 7	D 1 0 0 0	■

← Input area

↑ Display example for DWOVP K2147483647 D1000

"■" moves to the specified direction (left/right) with or key.

In this operating manual, the List editor function key is represented in the following abbreviation form.

- (1) Expression of $\boxed{\text{Key 1}} \rightarrow \boxed{\text{Key 2}} \rightarrow \dots \rightarrow \boxed{\text{Key n}}$ means the sequential input from $\boxed{\text{Key 1}}$ to $\boxed{\text{Key n}}$.
- (2) Expression of $\boxed{\text{Key 1}} + \boxed{\text{Key 2}}$ means input of $\boxed{\text{Key 1}}$ and $\boxed{\text{Key 2}}$ at the same time.
- (3) As in $\boxed{\text{RST}}_0$ key or $\boxed{\text{MOV}}_M$ key, keys with dual functions for input of the command or the device/constant or control keys that control the List editor function are represented as follows:
 - (a) The mode command or only alphanumeric characters are described.

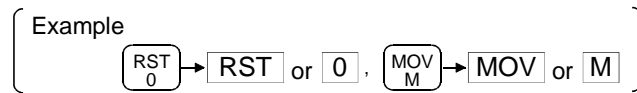

- (b) Only commands are shown for explanation of command input. (Alphanumeric characters are omitted.)
 Only alphanumeric characters are shown for explanation of alphanumeric characters. (Command expressions are omitted.)

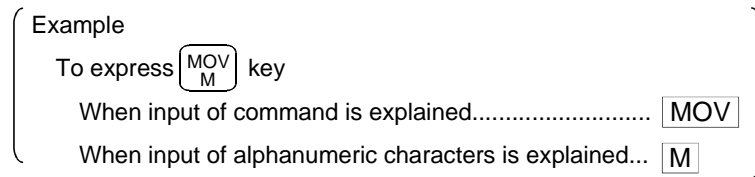

3.5.5 Display format on the display

The following describes the position and content of each data field in the display area provided by the List editor function.

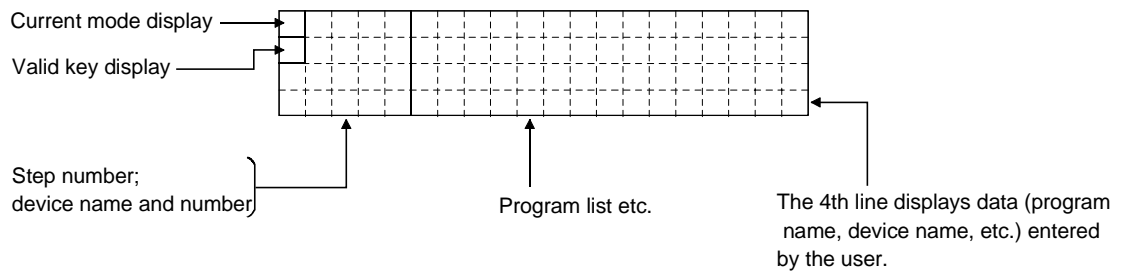

(1) Mode and valid key display

The following describes the mode and valid key display.

The mode display shows the list editor function mode selected by the user.

The valid key display shows which of the two functions assigned to each key is currently available: the function indicated at the upper part of the key or the function indicated at the lower part of the key.

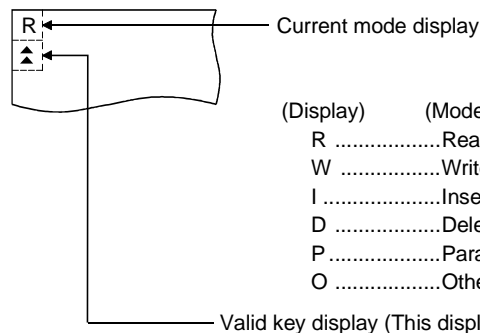

- | (Display) | (Mode) |
|-----------|----------------|
| R | Read mode |
| W | Write mode |
| I | Insert mode |
| D | Delete mode |
| P | Parameter mode |
| O | Other mode |

Valid key display (This display is not always available.)

With regard to keys framed in dotted lines in the figure shown at the left, the valid key display indicates which of the two functions assigned to each key is valid:

- ▲ : Function indicated at the upper part of each key is available.
- ▼ : Function indicated at the lower part of each key is available.

Example: FROM A key

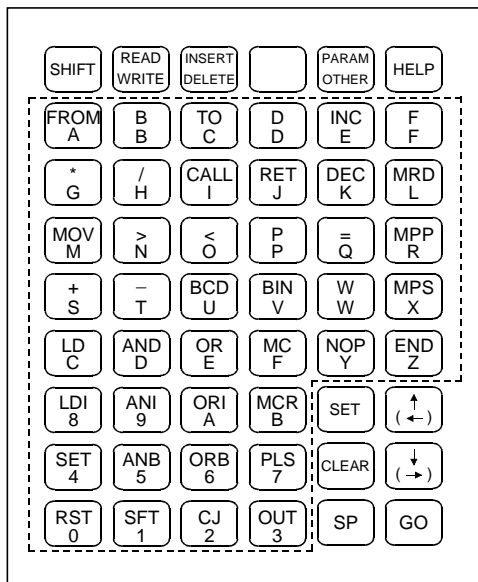
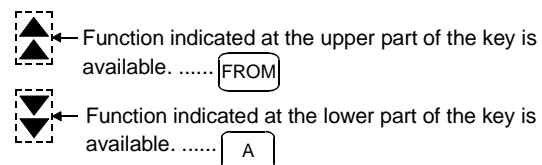

POINTS
To switch between two functions of keys (functions indicated at upper and lower parts of the keys), press the SHIFT and SET keys. For details, see Section 20.1.1

(2) Cursor display

The GOT controls the display of the cursor when the user has to input data; it displays a "■" at the cursor position. For more information, see Paragraph (6) below.

If the cursor overlaps the display of a character, however, the character and "■" alternate on the display.

(3) Indication of the selected line

When a program list is displayed, the line currently selected for editing is indicated by "▶" appearing immediately after the step number.

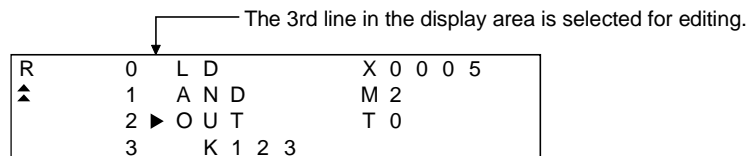

You can use the and keys to move "▶" up and down.

(4) Step number display

A step number is displayed as a decimal number.

On the 1st and 2nd lines in the display area, significant digits in the lower four digits of a step number are displayed.

On the 3rd and 4th lines in the display area, up to five significant digits in a step number are displayed.

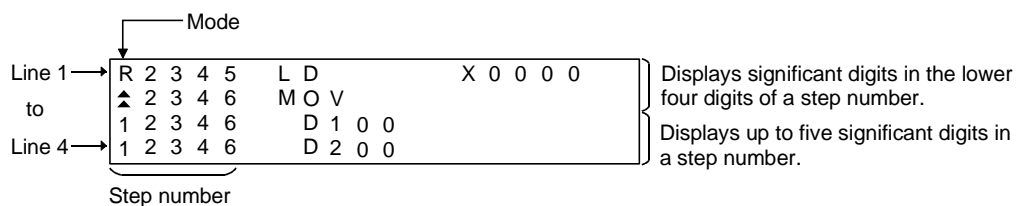

(5) Device display

Two or more device specifications attached to a basic or application instruction are displayed using the same step number.

For information on the step numbers, see Paragraph (4) above.

(6) Display of data input from the keys

Data input from the keys will appear at the cursor position. As more characters are input, the cursor moves to the right.

The cursor appears as "■".

Example: The user enters → →

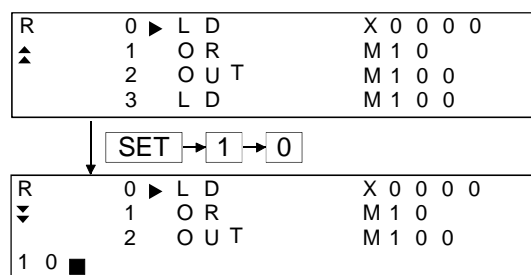

(7) Shifting of data to the left during the input of a program

When the user inputs a program, the codes entered before a touch on the **GO** key will appear on the 4th (bottom) line of the display area.

If the codes cannot appear on a single line, the display on the 4th line only will shift by a single character position to the left each time the user touches a key. (Each character that goes out of the display area by the left-shift operation is retained in the memory.)

W	1	1	5	M	5	X	0	0	0	5							
▲	1	2	0	L	D	M	3										
	1	2	1	▶	N	0	P										
P	K	2	1	4	7	4	8	3	6	4	7	D	1	0	0	0	■

↑ The user has entered "DMOVP K2147483647 D1000".

(8) Numerical display

The following describes the display of numerical values in devices and of constants in a program input by the user. Note, however, that only some examples are shown. For details, see Chapter 20.

Example: D1000 **4231H**

1) Display in decimal format

Only significant digits are displayed with zero-suppression.

M	D	1	0	0	0	1	6	4	9	5
---	---	---	---	---	---	---	---	---	---	---

2) Display in hexadecimal format

Four digits are displayed without zero-suppression.

M	D	1	0	0	0	H	4	2	3	1
---	---	---	---	---	---	---	---	---	---	---

3) Display in octal format

Six digits are displayed without zero-suppression.

M	D	1	0	0	0	0	0	4	1	0	6	1
---	---	---	---	---	---	---	---	---	---	---	---	---

4) ASCII format

A numerical value in the specified device is read in byte units and converted into associated character codes.

If a value fell outside the ranges 20H through 7FH and A0H through DFH, dots "." will appear.

M	D	1	0	0	0	a	s	c	i	i	B	1
---	---	---	---	---	---	---	---	---	---	---	---	---

(9) Display of an error message

An error message will appear on the 4th line of the display area.

If an error message appears, perform corrective action as described in Chapter 21.

An error message on the display is cleared when you press any key. Then the display resumes the state before the appearance of the error message.

3.5.6 List of List editor function

Mode (mode display)	Function				Action
Write (W)	Write program				Writes, adds, or modifies a program.
	Change device				Changes a device used at the selected step in the program
	Help	Write	Instruction help	Display/select instruction	Displays a list of instructions that start with the specified character and allows the user to choose from them.
				Read step	Reads a program after allowing the user to specify a step number.
			NOP continuous		Declares the specified part of the program NOP.
Comment display				Displays a comment for the specified device.	
Read (R)	Read program				Reads a program after allowing the user to specify a step number. Reads a program after allowing the user to specify an instruction used. Reads a program after allowing the user to specify a device used.
	Automatic scrolling				Automatically scrolls the display of a program that has been read up to a specified step.
	Help	Read	Step	Corresponds to program read and automatic scroll functions described above.	
			Instruction		
			Device		
Automatic scrolling					
Comment display				Displays a comment for the specified device.	
Insert (I)	Insert program				Inserts a new program into the displayed program.
	Help	Insert	Instruction help	Display/select instruction	Displays a list of instructions that start with the specified character and allows the user to choose from them.
				Read step	Reads a program after allowing the user to specify a step number.
			Move		Moves the selected part of the program to a specified part of the program.
	Copy		Copies the selected part of the program to a specified part of the program.		
Comment display				Displays a comment for the specified device.	
Delete (D)	Delete program				Deletes a program at the specified step.
	Help	Delete	Specified block	Deletes the specified block in the program.	
			All NOPs	Deletes all NOP instructions found in program codes described before the END instruction. (NOPLF instructions will not be deleted.)	
Comment display				Displays a comment for the specified device.	
Parameter (P)	Clear all parameters				Clears all parameters in the ACPU only.
	Set parameter				Sets or changes various parameters like those for the memory capacity, timer/counter, and latching range. Sets or changes a keyword.

Mode (mode display)	Function		Action	
Others (O)	Change T/C set values		Changes values set to timer/counter devices.	
	PC check	Read erroneous step	Displays details of an error in the ACPU and the associated step number.	
		Program check		Checks duplex coils, instruction codes, and other elements in the program.
	PC system	Monitor	Buffer memory batch monitor	With regard to a special function unit of the specified I/O number, monitors the contents of the buffer memory at the specified address.
			Clock monitor	Monitors the ACPU clock (D9025 through D9027).
		Monitor All clear	PC memory	Clears all contents of the ACPU memory and resets it to the initial state.
			Program	Clears the program (Main/Sub) currently selected.
			Device memory	Clears all device memories except for special-D, special-M, and R.
		Switch	PC No. setup	Switches the target ACPU in GOT operations in each mode.
			Switch Main/Sub	Switches the target program (Main/Sub) in GOT operations in each mode.
		Others	Remote RUN/STOP	Forcibly changes the ACPU running status between RUN and STOP.
	Machine language read/write		Performs a read or write operation to the ACPU memory in the machine language.	

3.6 Specifications of the motion monitor function

POINTS	Refer to Section 2.3 for the restrictions on the motion monitor function.
--------	---

3.6.1 PLC CPUs that can be monitored

The motion controller CPUs that can be monitored are only the Q172CPU and Q173CPU.
Refer to Section 2.3 (2) for details.

3.6.2 Access ranges that can be monitored

For the access ranges where the motion monitor function can be performed, refer to Chapter 2 of the GOT-A900 Series User's Manual (GT Works Version 5/GT Designer Version 5 Compatible Connection).

3.6.3 Precautions for use of the motion monitor function

When using the motion monitor function, use the motion controller CPU (Q172CPU, Q173CPU) that satisfies the following conditions.

- Installed motion controller OS version: "00E" or later
- Serial No.: "K*****" or later (Q172CPU)
"J*****" or later (Q173CPU)

3.6.4 Memory space necessary to use the motion monitor function

The following indicates the memory spaces for motion monitor data.
The memory space needed to store data into the built-in memory of the GOT is the same as the memory space needed to store data into the hard disk of the personal computer.

Stored Data	Memory Space [k bytes]
Information common to motion monitor data	13.4
A985GOT	200
A97*GOT	200
A960GOT	200
A956WGOT	115
A95*GOT	110

3.7 Specifications of the Servo Amplifier Monitor Functions

POINT
Refer to Section 2.3 for the restrictions on the servo amplifier monitor functions.

3.7.1 List of servo amplifier models that can be monitored and functions

The following table lists the servo amplifier models, where the servo amplifier monitor functions can be performed, and the functions.

Function		Servo Amplifier		MR-J2M A Series	
		MR-J2S-□A	MR-J2S-□CP	MR-J2M-P8A	MR-J2M-□DU
Setup	Model selection	○	○	○	○
	Baudrate	○	○	○	○
	Station number selection	○	○	—	—
	Station number setting	○	○	○	○
	IFU station number	—	—	○	○
Monitor	Batch display	○	○	○	○
Alarm	Alarm display	○	○	○	○
	Alarm history	○	○	○	○
Diagnostics	DI/DO display	○	○	○	—
	Function device display	—	○	○	○
	Amplifier information display	○	○	○	○
	ABS data display	○	○	—	○
	Module composition list display	—	—	○	○
Parameters	Parameter setting	○	○	—	—
	Parameters (IFU)	—	—	○	○
	Parameters (DRU)	—	—	○	○
Test	JOG operation	○	○	—	○
	Positioning operation	○	○	—	○
	Motorless operation	○	○	—	○
	DO forced output	○	○	○	—

○: Function available —: Function unavailable

3.7.2 Access range that can be monitored

The access range where the servo amplifier monitor functions can be performed is as follows.

- (1) When RS-232C communication function is used
Only the connected servo amplifier can be monitored.
- (2) When RS-422 communication function is used (multidrop communication)
The servo amplifier from among up to 32 axes of servo amplifiers, stations 0 to 31, on the same bus as the connected servo amplifier can be monitored.

3.7.3 Precautions for use of the servo amplifier monitor functions

- (1) Before starting test operations, always read the precautions in Section 26.7.1.
- (2) The maximum communication speed between the GOT and servo amplifier is 38400bps.
Set the servo side communication speed to 38400bps or less.
- (3) If the PLC CPU connected to the GOT does not have clock data, the time displayed by the servo amplifier monitor functions is not precise.
- (4) The settings of the GOT side servo amplifier monitor functions (setup screen (refer to Section 26.2.1)) should be the same as the servo amplifier side settings.
If they are different, normal communication may not be made.
- (5) When the servo amplifier monitor functions are used, communication from GT Designer (OS installation/monitor screen data downloading) cannot be made.
Before starting communication from GT Designer, terminate the servo amplifier monitor functions.
- (6) When the servo amplifier is connected, the bar code function cannot be used.
- (7) The transparent function cannot be used on the GOT where the servo amplifier monitor function operating system (OS) has been installed.

3.7.4 System configuration for servo amplifier connection

The system configurations for servo amplifier connection are shown below.

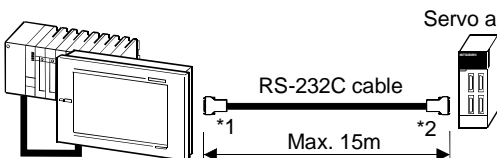
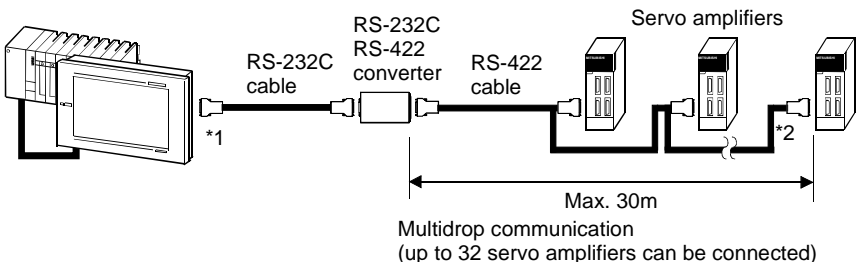
Connection Condition	System Configuration
When only one servo amplifier is connected	
When multiple ^{*3} (2 to 32) servo amplifiers are connected	

*1 Connect the GOT side connector into the RS-232C interface at the bottom of the GOT used for downloading the monitor screen data.

*2 Connect the servo amplifier side connector to CN3.

*3 As the servo amplifier to be monitored, select one from among the 32 servo amplifiers.

3.7.5 Monitor screen types and memory capacities necessary to use the servo amplifier monitor functions

The monitor screens used for the servo amplifier monitor functions change depending on the GOT model and monitored servo amplifier model.

The following tables indicate the monitor screen types and memory capacities necessary to use the servo amplifier monitor functions.

(1) When A985GOT is used

Function Details		Stored Screen Data	Memory Capacities [Bytes]			
			For MR-J2S- □A monitor	For MR-J2S- □CP monitor	For MR-J2M- P8A monitor	For MR-J2M- □DU monitor
Servo amplifier monitor data common information			18416			
Monitor		600 "Servo (A985) Monitor: ALL"	4132			
Alarm	Alarm display	613 "Servo (A985) Alarms: ALL"	2268			
	Alarm history	615 "Servo (A985) Alarms Hist.: ALL"	3020			
Diagnostic function	DI/DO display	617 "Servo (A985) I/O Display: S-A"	2436	—	—	—
		618 "Servo (A985) I/O Display: S-CP"	—	2608	—	—
		619 "Servo (A985) I/O Display: M-A IFU"	—	—	4522	—
		620 "Servo (A985) I/O Display: M-A D01"	—	—	—	3488
	Function device display	624 "Servo (A985) Function Dev.: S-CP"	—	2948	—	—
		625 "Servo (A985) Function Dev.: M-A IFU"	—	—	4808	—
		626 "Servo (A985) Function Dev.: M-A DRU"	—	—	—	4744
	Amplifier information display	628 "Servo (A985) Amp inf.: S-A"	2112	—	—	—
		629 "Servo (A985) Amp inf.: S-CP"	—	2188	—	—
		630 "Servo (A985) Amp inf.: M-A IFU"	—	—	2012	—
		631 "Servo (A985) Amp inf.: M-A DRU"	—	—	—	2204
	ABS data display	635 "Servo (A985) ABS data: S-A"	2700	—	—	—
		636 "Servo (A985) ABS data: S-CP"	—	2916	—	—
		637 "Servo (A985) ABS data: M-A DRU"	—	—	—	2928
Unit composition list display	639 "Servo (A985) Unit Comp.: M-A IFU"	—	—	3444	—	
	640 "Servo (A985) Unit Comp.: M-A DRU"	—	—	—	3432	
Parameter setting	643 "Servo (A985) Parameters: S-**"	3656		—	—	
	644 "Servo (A985) Parameters: M-A IFU"	—	—	3872		
	645 "Servo (A985) Parameters: M-A DRU"	—	—	—	4452	
Test	Jog operation	678 "Servo (A985) Jog op.: S-**"	2672		—	—
		679 "Servo (A985) Jog op.: M-A DRU"	—	—	—	2476
	Positioning operation	682 "Servo (A985) Positioning: S-**"	3056		—	—
		683 "Servo (A985) Positioning: M-A DRU"	—	—	—	2860
	Motor-less operation	685 "Servo (A985) Motor-less op: S-**"	2300		—	—
		686 "Servo (A985) Motor-less op: M-A DRU"	—	—	—	2140
	DO forced output	688 Servo (A985) DO Forced Out: S-A"	2844	—	—	—
		689 Servo (A985) DO Forced Out: S-CP"	—	2724	—	—
690 "Servo (A985) DO Forced Out: M-A IFU"		—	—	4692	—	
691 "Servo (A985) DO Forced Out: M-A D01"		—	—	2540	—	

(2) When A97*GOT/A960GOT is used

Function Details		Stored Screen Data	Memory Capacities [Bytes]			
			For MR-J2S- <input type="checkbox"/> A monitor	For MR-J2S- <input type="checkbox"/> CP monitor	For MR-J2M- P8A monitor	For MR-J2M- <input type="checkbox"/> DU monitor
Servo amplifier monitor data common information			18416			
Monitor		700 "Servo (A97*) Monitor: ALL"	4132			
Alarm	Alarm display	713 "Servo (A97*) Alarms: ALL"	2268			
	Alarm history	715 "Servo (A97*) Alarms Hist.: ALL"	3020			
Diagnostic function	DI/DO display	717 "Servo (A97*) I/O Display: S-A"	2436	—	—	—
		718 "Servo (A97*) I/O Display: S-CP"	—	2608	—	—
		719 "Servo (A97*) I/O Display: M-A IFU"	—	—	4452	—
		720 "Servo (A97*) I/O Display: M-A D01"	—	—	3488	—
	Function device display	724 "Servo (A97*) Function Dev.: S-CP"	—	2948	—	—
		725 "Servo (A97*) Function Dev.: M-A IFU"	—	—	4920	—
		726 "Servo (A97*) Function Dev.: M-A DRU"	—	—	—	4908
	Amplifier information display	728 "Servo (A97*) Amp inf.: S-A"	2112	—	—	—
		729 "Servo (A97*) Amp inf.: S-CP"	—	2188	—	—
		730 "Servo (A97*) Amp inf.: M-A IFU"	—	—	2012	—
		731 "Servo (A97*) Amp inf.: M-A DRU"	—	—	—	2204
	ABS data display	735 "Servo (A97*) ABS data: S-A"	2700	—	—	—
		736 "Servo (A97*) ABS data: S-CP"	—	2916	—	—
		737 "Servo (A97*) ABS data: M-A DRU"	—	—	—	2928
Unit composition list display	739 "Servo (A97*) Unit Comp.: M-A IFU"	—	—	3444	—	
	740 "Servo (A97*) Unit Comp.: M-A DRU"	—	—	—	3432	
Parameter setting	743 "Servo (A97*) Parameters: S-**"	3656		—	—	
	744 "Servo (A97*) Parameters: M-A IFU"	—	—	3872		
	745 "Servo (A97*) Parameters: M-A DRU"	—	—	—	4180	
Test	JOG.Jog operation	778 "Servo (A97*) Jog op.: S-**"	2672		—	—
		779 "Servo (A97*) Jog op.: M-A DRU"	—	—	—	2476
	Positioning operation	782 "Servo (A97*) Positioning: S-**"	3056		—	—
		783 "Servo (A97*) Positioning: M-A DRU"	—	—	—	2860
		Motor-less operation				
		785 "Servo (A97*) Motor-less op: S-**"	2300		—	—
	786 "Servo (A97*) Motor-less op: M-A DRU"	—	—	—	2140	
	DO forced output	788 Servo (A97*) DO Forced Out: S-A"	2724	—	—	—
789 Servo (A97*) DO Forced Out: S-CP"		—	2724	—	—	
790 "Servo (A97*) DO Forced Out: M-A IFU"		—	—	4692	—	
791 "Servo (A97*) DO Forced Out: M-A D01"		—	—	2540	—	

(3) When A95*GOT/A956WGOT is used

Function Details		Stored Screen Data	Memory Capacities [Bytes]			
			For MR-J2S- <input type="checkbox"/> A monitor	For MR-J2S- <input type="checkbox"/> CP monitor	For MR-J2M- P8A monitor	For MR-J2M- <input type="checkbox"/> DU monitor
Servo amplifier monitor data common information			18416			
Monitor		800 "Servo (A95*) Monitor: ALL"	2252			
Alarm	Alarm display	822 "Servo (A95*) Alarms: ALL"	1612			
	Alarm history	824 "Servo (A95*) Alarms Hist.: ALL"	2040			
Diagnostic function	DI/DO display	826 "Servo (A95*) I/O Display: S-A"	1944	—	—	—
		827 "Servo (A95*) I/O Display: S-CP"	—	2124	—	—
		828 "Servo (A95*) I/O Display: M-A IFU"	—	—	3436	—
		829 "Servo (A95*) I/O Display: M-A D01"	—	—	—	2808
	Function device display	833 "Servo (A95*) Func.Dev.: S-CP"	—	2188	—	—
		834 "Servo (A95*) Func.Dev.In1: M-A IFU"	—	—	2740	—
		835 "Servo (A95*) Func.Dev.In2: M-A IFU"	—	—	2696	—
		836 "Servo (A95*) Func.Dev.Out1: M-A IFU"	—	—	2804	—
		837 "Servo (A95*) Func.Dev.Out2: M-A IFU"	—	—	2848	—
		838 "Servo (A95*) Func.Dev.In1: M-A DRU"	—	—	—	2792
		839 "Servo (A95*) Func.Dev.In2: M-A DRU"	—	—	—	2684
		840 "Servo (A95*) Func.Dev.Out1: M-A DRU"	—	—	—	2728
	Amplifier information display	841 "Servo (A95*) Func.Dev.Out2: M-A DRU"	—	—	—	2336
		843 "Servo (A95*) Amp inf.: S-A"	1396	—	—	—
		844 "Servo (A95*) Amp inf.: S-CP"	—	1472	—	—
		845 "Servo (A95*) Amp inf.: M-A IFU"	—	—	1296	—
	ABS data display	846 "Servo (A95*) Amp inf.: M-A DRU"	—	—	—	1488
		850 "Servo (A95*) ABS data Cur.: S-A"	1744	—	—	—
		851 "Servo (A95*) ABS data Orig: S-A"	1816	—	—	—
		852 "Servo (A95*) ABS data Cur.: S-CP"	—	1960	—	—
853 "Servo (A95*) ABS data Orig: S-CP"		—	2032	—	—	
Unit composition list display	854 "Servo (A95*) ABS data Cur.: M-A DRU"	—	—	—	1972	
	855 "Servo (A95*) ABS data Orig: M-A DRU"	—	—	—	2044	
Parameter setting	857 "Servo (A95*) Unit Comp.: M-A IFU"	—	—	2512	—	
	858 "Servo (A95*) Unit Comp.: M-A DRU"	—	—	—	2500	
	861 "Servo (A95*) Parameters: S-**"	2860		—	—	
Test	Jog operation	862 "Servo (A95*) Parameters: M-A IFU"	—	—	3064	
		863 "Servo (A95*) Parameters: M-A DRU"	—	—	—	3300
Test	Jog operation	906 "Servo (A95*) Jog operation: S-**"	1944		—	—
		907 "Servo (A95*) Jog operation: M-A DRU"	—	—	—	1752
	Positioning operation	910 "Servo (A95*) Positioning: S-**"	2328		—	—
		911 "Servo (A95*) Positioning: M-A DRU"	—	—	—	2136
	Motor-less operation	913 "Servo (A95*) Motor-less op: S-**"	1584		—	—
		914 "Servo (A95*) Motor-less op: M-A DRU"	—	—	—	1388
	DO forced output	916 Servo (A95*) DO Forced Out: S-A"	2128	—	—	—
917 Servo (A95*) DO Forced Out: S-CP"		—	2008	—	—	
918 "Servo (A95*) DO Forced Out: M-A IFU"		—	—	3332	—	
919 "Servo (A95*) DO Forced Out: M-A D01"		—	—	1728	—	

CHAPTER4 OPERATING THE UTILITY FUNCTION

4.1 Utility function table

Functions	Description	Remarks	Ref. section
Brightness/contrast adjustment	Adjusting the brightness/contrast of a monitor screen.	This function changes with the GOT used.	Section 4.3
System monitor	Monitoring or changing devices in a PLC CPU.	This function can be executed only after installing an OS, monitor data on the GOT by using GT Designer.	Chapter 9
Special module monitor	Monitoring or changing buffer memory of a special module.	This function can be executed only when the GOT memory is extended and the OS is installed from the GT Designer to the GOT.	Chapter 12
Screen & OS copy	Copying of screen data between internal memory and memory card Copying of OS data between internal memory and memory card	Refer to the HELP function GT Designer to install the OS (from memory card to internal memory).	Section 4.4
Setup	The options of settings include: <ul style="list-style-type: none"> • Language used in a message display (Japanese/English) • Buzzer sound adjustment • Sounds from an external speaker • Idle time for a screen saver • Backlighting for a screen saver • Protocol and baud rate when connected to a microcomputer • Reverse display • Extension number and slot number for bus connection with QCPU • Transmission speed for Computer link connection • Transmission speed for Omron/Yaskawa/Hitachi/Matsushita PLC connection • Startup time, transmission delay and CCU monitor registration (Matsushita Electric Works PLC only) for Yaskawa/Matsushita Electric Works PLC connection • Transmission speed and address for SIEMENS/Allen-Bradley PLC connection • Transmission time-out setting for CC-Link (ID) driver installation • Setting of disable-enable/detection sensitivity/OFF delay for screen save/human sensor • Grip switch enable/disable setting (A950 handy GOT only) • Adjusting the color balance/contrast/brightness/color power of a video window. • Adjusting the clock phase H-Position/V-Position of an RBG window, and setting the touch key position for a return to the monitor screen. 		Section 4.5
Self-test	The self-test include diagnostic checks on GOT hardware as follows: <ul style="list-style-type: none"> • Drawing check • Font check • Memory card check • User-space-in-the-internal-memory check • OS-space-in-the-internal-memory check • CPU communications check • Touch key check 		Section 4.6
Memory information	The contents of GOT memory information include: <ul style="list-style-type: none"> • OS version number • Status of communications with the PLC CPU • Available space in the internal memory • Availability of memory cards and available space in a memory card • Availability of the ladder monitor function 		Section 4.7
Ladder monitor	Monitoring the sequence programs on the PLC CPU.	This function can be executed only when the GOT memory is extended and the OS is installed from the GT Designer to the GOT.	Chapter 6
Clock	Setting date and time.		Section 4.8
Screen cleanup	Displaying the display area cleanup screen.		Section 4.9
Network monitor	Monitoring the line status of MELSECNET.	This function can be executed only when the GOT memory is extended and the OS is installed from the GT Designer to the GOT.	Chapter 17
Security password	Changing the security levels of numeric input and objects.	If a security password is defined by using GT Designer, security levels can be changed.	Section 4.10
Password	Defining a password for limited access to the utility menu screen.		Section 4.11
List edit	List editing of PLC programs in PLC CPU	This function can be executed only when the GOT memory is extended and the OS is installed from the GT Designer to the GOT.	Chapter 19
Motion monitor	Motion controller CPU (Q172CPU/Q173CPU) Changing of servo monitor/servo parameter setting	This function can be executed only when the GOT memory is increased and the OS is installed from GT Designer to the GOT.	Chapter 22
Servo amplifier monitor	Servo amplifier monitor, servo parameter setting change, test operation		Chapter 25

4.2 Selecting the utility function

This section describes how to select the utility function.

The utility function can be activated with a touch of the screen.

To select the utility function, follow either of the following two steps.

- (1) Touch the upper right and left corners of the screen at the same time.

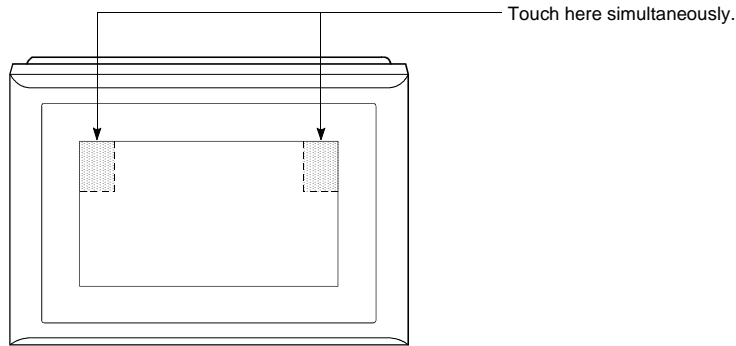

- (2) Touch a touch key displayed on the monitor screen. A touch key can be set in the touch key (expanded) function settings.

The following flowchart outlines the steps involved in selecting the utility function.

Touch  after changing the setup data.

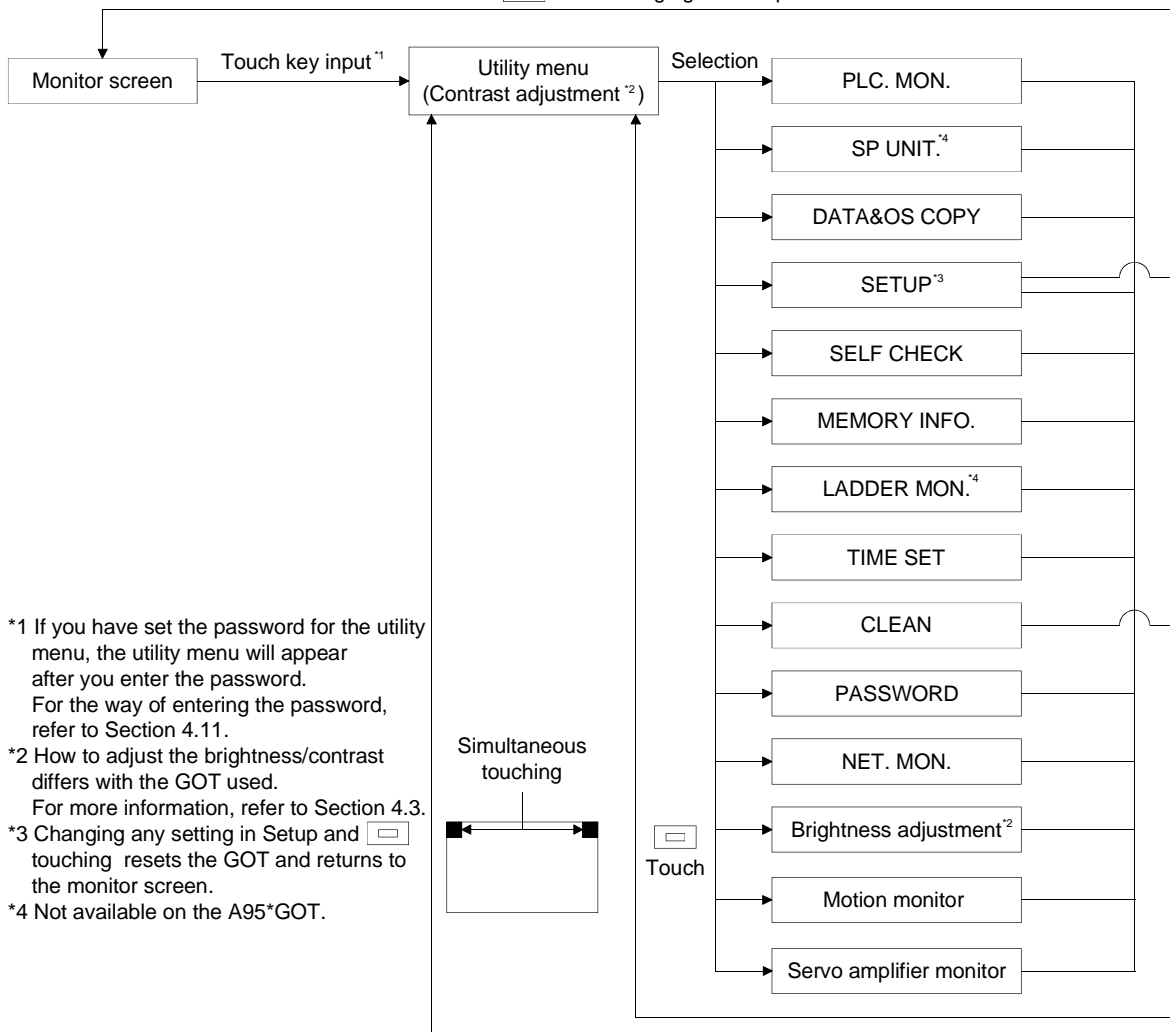

*1 If you have set the password for the utility menu, the utility menu will appear after you enter the password. For the way of entering the password, refer to Section 4.11.
 *2 How to adjust the brightness/contrast differs with the GOT used. For more information, refer to Section 4.3.
 *3 Changing any setting in Setup and  resets the GOT and returns to the monitor screen.
 *4 Not available on the A95*GOT.

4.3 Selecting the required function on the utility menu screen (Adjusting the brightness/contrast of the monitor screen)

(1) Display screen

The display screen differs with the GOT used.

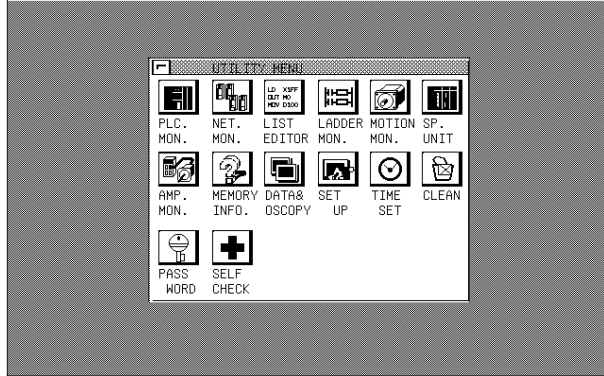
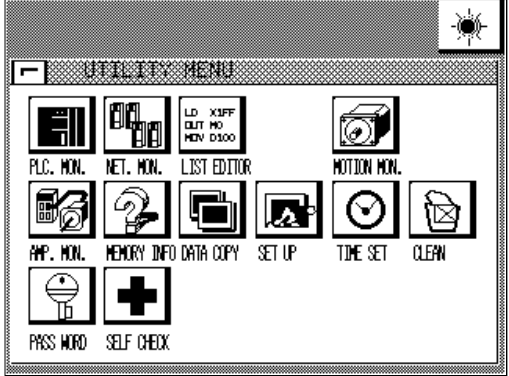
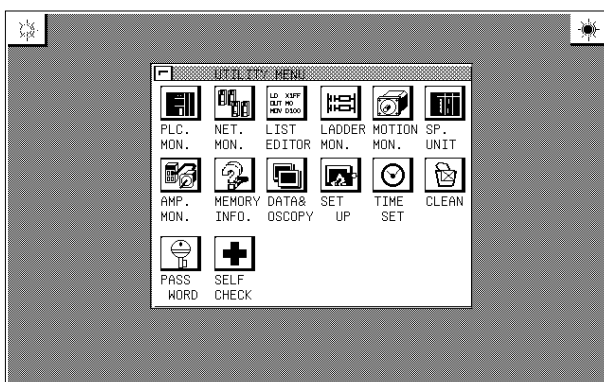
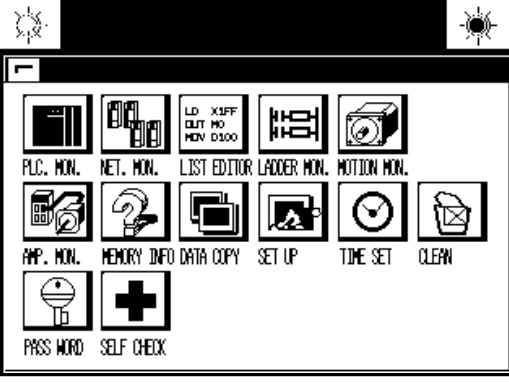
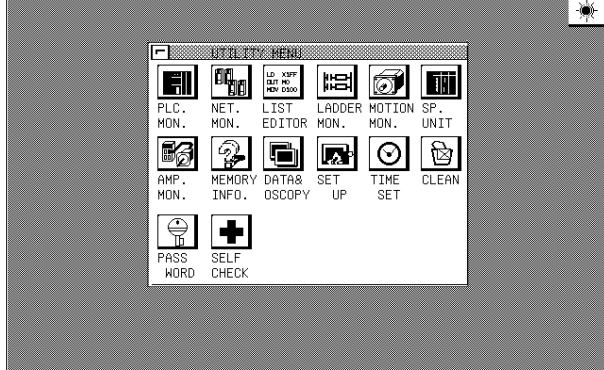
Screen Example	
A985/97*/960GOT	A95*/A956WGOT
	
	
	

(2) Function

- Menu screen used to select any of the utility functions.
- Used to adjust the brightness/contrast of the monitor screen.

(3) Operation



(a) Basic operation

Directly touch the portion where the function you will select is being displayed.

(b) Return to the monitor screen

Touch  to return to the monitor screen.

(c) Brightness/contrast adjustment

- Touch   and at top of the screen to make contrast adjustment.
- You can adjust the contrast in about 20 steps.
- Touch  at top right of the screen to show the brightness adjustment-screen.

For details of the adjustment method on the brightness adjustment screen, refer to section 4.12.

POINTS	
	<ul style="list-style-type: none"> • If the OS is not installed on the GOT, items are displayed on the system monitor, but they cannot be selected. • If the following conditions for use of the corresponding functions are not satisfied, the special function module monitor, ladder monitor, network monitor, motion monitor and servo amplifier monitor items are displayed in the utility menu but cannot be selected. <ul style="list-style-type: none"> (a) A985/97*/960GOT/956WGOT <ul style="list-style-type: none"> • The memory board is loaded in the GOT. • The extended function OS is installed in the GOT. (b) A95*GOT <ul style="list-style-type: none"> • The compatible model (A95*GOT-*BD-M3) is used. • The extended function OS is installed in the GOT. • If the GOT is connected to the PLC CPU without clock function, items are displayed on the clock window, but they cannot be selected.

(4) On-screen error messages

Message	Cause	Corrective Action
Can't be selected (When system monitor, special module monitor, ladder monitor, motion monitor, servo amplifier monitor or clock setting is selected)	<ul style="list-style-type: none"> • The OS is not installed on the GOT. • The memory board is not installed in the A985/97*/960/960WGOT. • The A95*GOT used is other than the A95*GOT-*BD-M3. • The GOT is connected to a PLC CPU without a clock function. 	<ul style="list-style-type: none"> • Install the OS. • Install the memory board in the A985/97*/960/960WGOT. • Use the A95*GOT-*BD-M3. • Replace the CPU with one with a clock function or do not use the clock setting.

4.4 Copying the monitor data/OS data between the internal memory and memory card (Screen & OS copy)

(1) Display screen

Sample screen

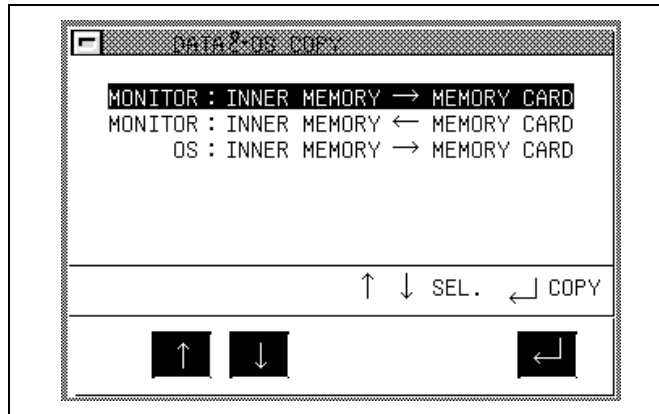

(2) Features

- Project data stored in the internal memory can be saved to the memory card.
- Project data stored in the memory card can be saved to the internal memory.
- OS data can be backed up by copying them from the internal memory to the memory card.

(3) Procedure

(a) Basic operation

- Touch or to select options.
- Touching will display a message asking you to answer the question "Do you want to execute?"
- If you answers Yes to the question, touch again. Touch or to select another option. To quit the backup copy, touch to return to the Utility Menu screen.

(b) To return to the Utility Menu screen:

- Touch to return to the Utility Menu screen.

(4) On-screen error messages

Message	Cause	Corrective Action
Cancel write protect function	The memory card is write-protected.	Release write protection of the memory card.
Install memory card	A memory card is not installed on the GOT.	Install a memory card on the GOT.
Format memory card	The installed memory card is not yet formatted.	Format the memory card.
Write Error (M-CARD capacity shortage) Data transfer error	Memory card loaded has memory space less than written data.	Change the memory card for the one having enough memory space.
M-CARD error Data transfer error	Write error occurred in the memory card during copying, or the memory card used has no free space.	Change the memory card, or increase the free space of the memory card.
Memory card error	The hardware of the installed memory card is defective.	Replace the memory card with a new one.

(5) Directory tree in a memory card

The directory tree in a memory card is shown as follows.

(File structure)

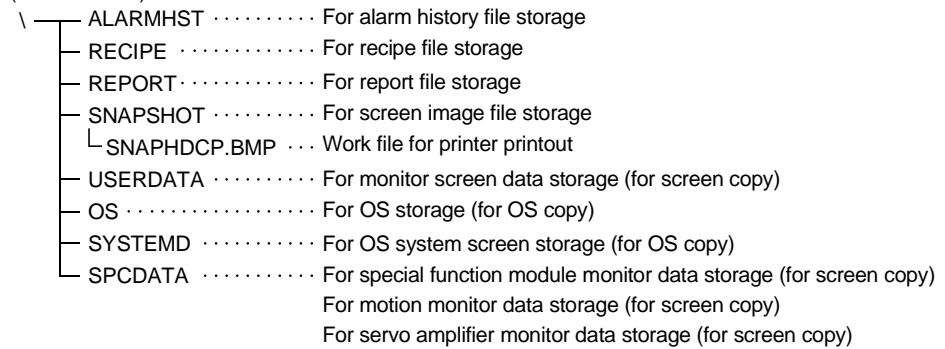

- (a) The copied screen data is stored under the UserData folder.
 Since the OS and screen data are managed by the Dlist.ini file and the Flist.ini files in the corresponding folders, always install or download the GT Designer OS (specify the PC card as the download destination) to create the memory card.
 If Explorer or like in the personal computer is used to copy the OS, the GOT cannot recognize the data in the memory card.
- (b) Do not edit the screen data in the memory card directly using GT Designer.
 Edit the screen data uploaded by connecting the personal computer and GOT by an RS-232C cable.
- (c) When copying the file (alarm history data, recipe data) in the memory card to the personal computer or deleting it, load the memory card into the personal computer and then copy or delete the data using Explorer of the personal computer.
 (When copying the screen data, use the data for backup purpose only. When editing, use the method in above (b).)
- (d) The SRAM type memory card can be formatted on the GOT.
 Check the memory card with the self-diagnostics of the utility function.
 When the memory card is checked, the memory card is formatted after the check.
 The compact flash PC card cannot be formatted on the GOT.
 Use the personal computer to format it.
 For the way to format the memory card, refer to the GT Works Version 5/GT Designer Version 5 Reference Manual.

POINTS	You cannot use this function to install the OS (from memory card to internal memory). For details of OS installation, refer to the Help function of GT Designer.
---------------	--

4.5 Setting the operating environment of the GOT (Setup)



POINT

After changing any of the items in Setup, touching  automatically resets the GOT and shows the monitor screen.

(1) Display screen

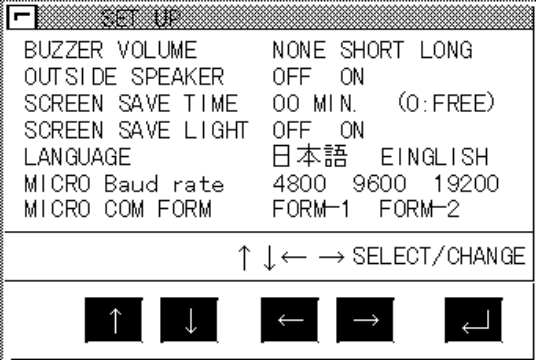
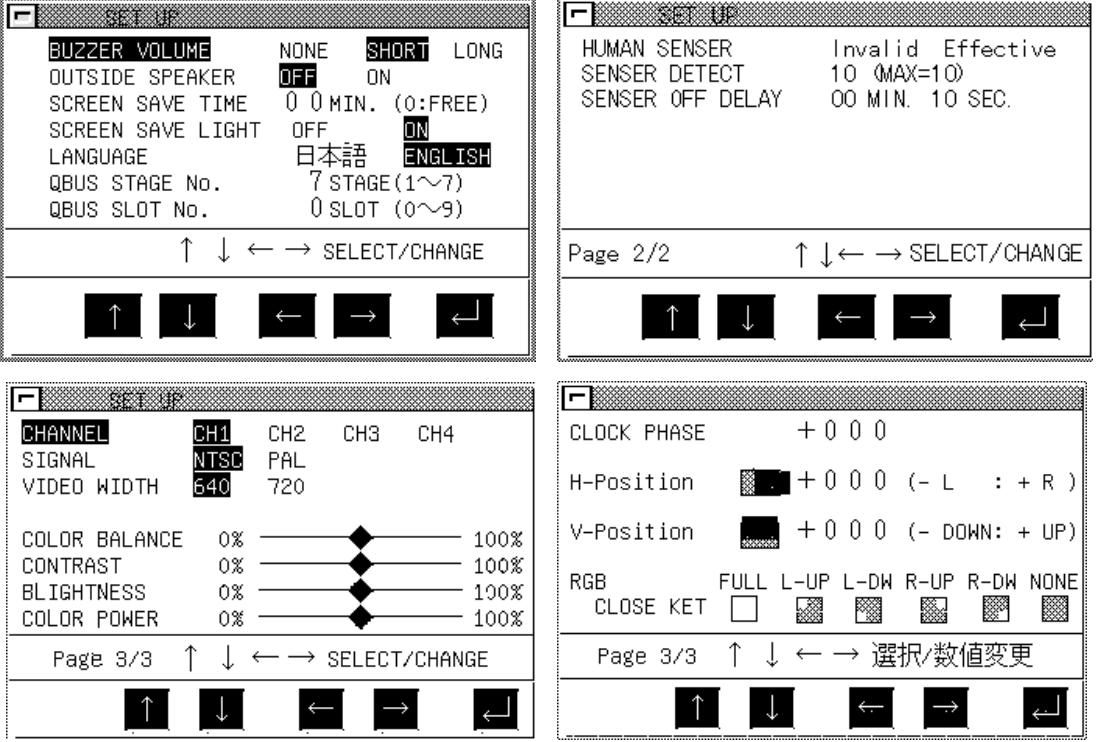
The display screen differs with the GOT used.

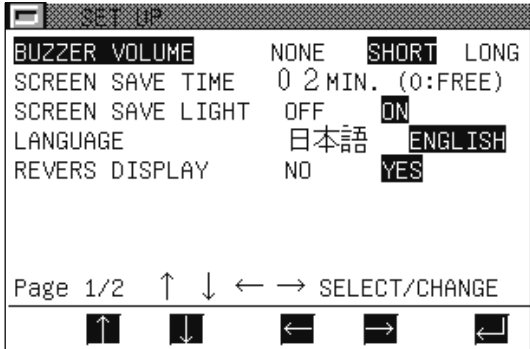
GOT Used	Screen Example
A97*GOT/ A960GOT	
	This screen example assumes that the communication driver "Computer" has been installed.
A985GOT (-V)	
	<p>This screen example assumes that the communication driver "Bus (Q)" has been installed.</p> <p>A video window (channel, etc.) and RGB screen (H-Position, etc.) may be set only when the A985GOT-V is used.</p>

GOT Used	Screen Example
A95*GOT	<div style="display: flex; justify-content: space-around;"> <div style="border: 1px solid black; padding: 5px; width: 45%;">  </div> <div style="border: 1px solid black; padding: 5px; width: 45%;">  </div> </div> <p>This screen example assumes that the communication driver other than "Bus(A, QnA)" has been installed.</p> <p>The grip switch setting and grip switch cancel-time key OFF setting are available only for use of the A950 handy GOT.</p>

(2) Functions

(a) Data that can be set on any GOT

- Buzzer volume
You can select the length of the beep sound.(Factory-set to SHORT)
- Outside speaker sound
You can select whether or not voice output is provided from the external speaker (only the voice specified for the touch input sound on the GT Designer).
(Factory-set to OFF)
- Screen save time
Set the time until the monitor screen display is switched off by the screen saver function.
You can set the time between "00 minutes" and "60 minutes".
When this setting is "0", the monitor screen is always displayed.(Factory-set to 0)
- Screen save light
When this setting is OFF, the backlight goes off as soon as the display is erased by the screen saver function.
When this setting is ON, the display will disappear but the backlight will not go off.
- Language
You can select the language (Japanese or English) of the messages to be displayed on the screen. (Factory-set to Japanese)

(b) Data that can be set when the corresponding communication driver is installed

1) When communication driver for bus connection (Q) is installed

- QBUS extension number
Set the GOT extension number for bus connection to the QCPU.
(Factory set to extension 7)
- QBUS slot number
Set the slot number where the GOT is assigned for bus connection to the QCPU. (Factory set to slot 0)

2) When communication driver for microcomputer connection is installed

- Microcomputer connection baud rate
You can select the transmission speed when the GOT is connected to a microcomputer.(Factory-set to 19200)
- Microcomputer connection communication form
You can select the protocol when the GOT is connected to a microcomputer.(Factory-set to FORM-1)

- 3) When communication driver for computer link connection (AJ71QC24) is installed
 - QC24 Baud rate
Set the transmission speed for connection with the QC24N.
(Factory-set to 19200bps)
- 4) When communication driver for OMRON/Hitachi PLC connection is installed
 - Baud rate
Choose the transmission speed for connection with the Omron or Hitachi PLC. (Factory-set to 19200bps)
- 5) When communication driver for Yasukawa PLC connection is installed
 - Baud rate
Choose the transmission speed (4800, 9600, 19200, 38400).
(Factory-set to 19200bps)
 - Startup time
Set when (seconds) to start communication with the PLC CPU after power-on of the GOT. (Factory-set to 16 seconds for the GL series or 1 second for other than the GL series)
 - Send message delay
Set the waiting time from when the GOT has received data from the PLC CPU until the GOT send the next data to the PLC CPU. (Factory-set to 0msec)
- 6) When communication driver for SIEMENS PLC connection is installed
 - Baud rate
Choose the transmission speed (4800, 9600, 19200, 38400).
(Factory-set to 19200bps)
 - Adapter address
Specify the MPI address on PROFIBUS assigned to the HMI adaptor connected to the GOT. (Factory-set to 2)
 - Host (FF) address
Specify the MPI address on PROFIBUS assigned to the HMI adaptor connected to the GOT. The specified PLC CPU is the "host" when monitor device setting is made on GT Designer.
For details of monitor device setting, refer to the help of GT Designer.
(Factory-set to 2)
- 7) When communication driver for Allen-Bradley PLC connection is installed
 - Baud rate
Choose the transmission speed (4800, 9600, 19200, 38400).
(Factory-set to 19200bps)
 - Adapter address
Set the address on the DH-485 network assigned to the HMI adaptor connected to the GOT. This setting is required only when multiple CPUs are connected to the GOT.
Set the same address as the DH-485 Node Address specified for the adaptor.
The DH-485 Node Address specified should not overlap the Node Address of the PLC on the DH-485 network. (Factory-set to 1)
 - Host (FF) address
Specify the address on the DH-485 network assigned to the PLC CPU to which the HMI adaptor is connected.
The specified PLC CPU is the "host" when monitor device setting is made on GT Designer.
For details of monitor device setting, refer to the help of GT Designer.
(Factory-set to 1)

- 8) When communication driver for Matsushita Electric Works PLC connection is installed
- Baud rate
Choose the transmission speed (4800, 9600, 19200, 38400).
(Factory-set to 19200bps)
 - Startup time
Set when (seconds) to start communication with the PLC CPU after power-on of the GOT. (Factory-set to 0msec)
 - Send message delay
Set the waiting time from when the GOT has received data from the PLC CPU until the GOT send the next data to the PLC CPU. (Factory-set to 3msec)
 - C.C.U monitor registration
Choose whether CCU monitor registration is made or not.
When multiple GOTs/peripheral devices are connected to one CPU via the C.C.U., up to one unit(When the CPU is the FP10SH, up to five units can be set) can be registered for C.C.U. monitor. When two or more GOTs are used or they are used with peripheral devices together, set "No" for C.C.U. monitor registration.
- 9) When communication driver for Ethernet connection is installed
- 10) When extended function OS for gateway functions is installed
- 11) When A9GT-J71E71-T module is connected
- GOT NET No.
Set the network number of the GOT. (Factory-set to 1)
 - GOT PC No.
Set the station number of the GOT.
Do not set the same number as the PC No. of the Ethernet module to be monitored. (Factory-set to 1)
 - GOT IP address
Set the IP address of the GOT.
 - GOT port No.
Set the port number of the GOT. (Factory-set to 5001)
 - Router address
When the network is connected to the other network by a router, set the router address of the network where the GOT is connected.
(Factory-set to 000.000.000.000)
 - Sub-net mask
When the GOT is connected to the Ethernet network which is controlled the sub-network, set the sub-network mask set commonly to the networks.
When the sub-network is not used, operation is performed at the default value. (Factory-set to 255.255.255.000)
 - Send message wait
Set the transmission wait time to reduce loads on the network and target PLC. (Factory-set to 0)
 - Send message time
Set the time-out period. (Factory-set to 3)
 - Startup time
Set when (seconds) to start communication after power-on of the GOT.
(Factory-set to 3msec)
- 12) When communication driver for CC-Link connection (CC-Link (ID)) is installed.
- Send message time
Set the time-out period. (Factory-set to 3)

(c) Data that can be set when the specific GOT is used

1) Setting of display mode (may be made for the A95*GOT-LBD(-M3) only)

- Reverse display
The display mode (normal display (No)/highlighted display (Yes)) is selected.
(Only A95*GOT-LBD (-M3) can be selected. Normal display is set at the time of shipment.)

2) Setting of human sensor (may be made for the A985GOT(-V) only)

- Screen save Human sensor
You can select whether the screen saver is deactivated or not when the Human sensor has detected a man's motion. (Available for the A985GOT only, factory-set to Invalid)
- Human sensor detection sensitivity
You can select the detection sensitivity of the Human sensor in any of 11 steps, levels 0 to 10, so that the sensor will not detect a motion such as a man passing before the GOT.
(Available for the A985GOT only, factory-set to 10)

Detection sensitivity setting	10	9	8	7	6	5	4	3	2	1	0
Monitor time [sec]	0	0.1	0.2	0.4	0.8	1	1.5	2	2.5	3	4

- Human sensor OFF delay
The Human sensor can be turned off when it does not detect a man's motion after it has turned on. You can set that period between "00 min. 10 sec." and "60 min. 00 sec.". (Available for the A985GOT only, factory-set to 00 min. 10 sec.)

3) Setting of grip switch (may be made for the A950 handy GOT only)

- Grip switch
You can set whether the grip switch will be used or not.
When the setting is USE, hold down the grip switch and perform operation. Setup and self-diagnostic operations can be performed independently of the grip switch.
(May be set only for the A950 handy GOT, factory-set to USE)
- If it is released
You can set whether the touch key pressed on the GOT display will be turned off or not at the time of grip switch cancel.
At the setting of "NO ACTION", the pressed touch key is turned off when it is released. (May be set only for the A950 handy GOT, factory-set to KEY OFF)

4) Setting of video window (may be selected only when the A9GT-80V4 is fitted to the A985GOT-V)

- Channel
You can choose the video channel for which video window settings are made.
The settings can be made per video channel.
- Signal
You can choose the video picture input system (NTSC/PAL).
- Video width
You can choose the video window resolution (720×480 dots/640×480 dots)
- Color balance/contrast/brightness/color power
You can adjust the contrast, brightness and others of the video picture displayed on the GOT. (May be selected only when the A9GT-80V4 is fitted to the A985GOT-V, factory-set to 50%)

- 5) Setting of RGB screen (may be selected only when the A9GT-80R1 is fitted to the A985GOT-V)
 - Clock phase
You can adjust the flicking of the RGB screen displayed on the GOT.
 - H-Position/V-Position
You can adjust the position of the RGB screen displayed on the GOT.
 - RGB close key
You can select which position of the screen to touch to switch from the RGB screen to the GOT monitor screen.
You can also turn on/off the bit device (RGB display controlling bit) to switch the screen.
For the RGB display controlling bit, refer to the GT Works Version 5/GT Designer Version 5 Reference Manual.
(Factory set to FULL)





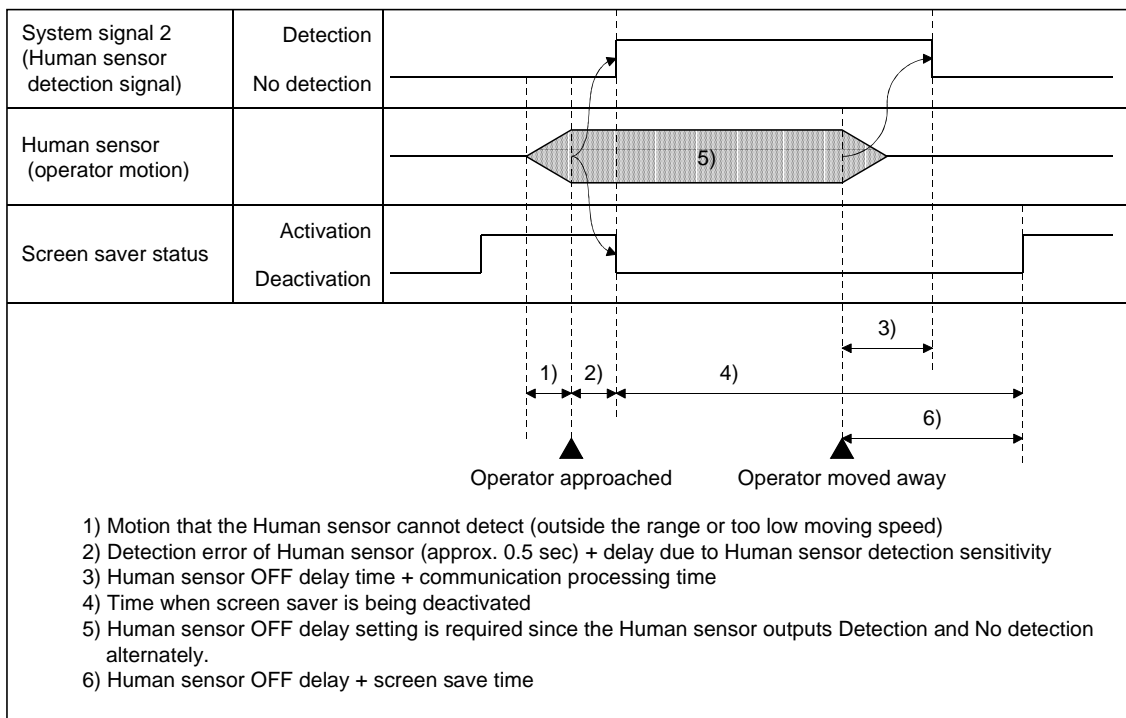

POINT



- If the touch panel is not touched within the specified time, the screen saver function switches off the display to prevent "burn-in" of the display device.
Especially for the display screen type of EL, it is recommended to use this function.
- Dedicated to the A985GOT, the Human sensor function automatically deactivates the screen saver, without any touch on the touch panel, by means of a signal detected by the Human sensor.
Using the system information function of the GOT, the signal detected by the Human sensor may also be controlled by the PLC CPU. For full information on the system information function, refer to the GT Designer HELP function.
Signal detection timings are shown below.





(3) Operation

(a) Basic operation



- Touch  or  to select the necessary item.
- When the A985GOT, A950 handy GOT is used, select the last item on Page 1/2 and touch  to show Page 2/2.
- For the setting item whose value will be changed, highlight the digit to be set by touching  , and set the value by touching  or .

(If you are going to select another setting item after that, return the highlight to the setting item by touching , and make selection by touching  or .)

- After setting, touch .

After touching , the GOT is automatically reset and the monitor screen appears.

(b) Return to each screen

- If any change has been made to the Setup settings, touching  resets and restarts the GOT.
- If any change has been made to the Setup settings, touching  resets and restarts the GOT.

The display returns to the utility menu or monitor screen.

4.6 Running diagnostic checks on GOT hardware (self-test)

(1) Display screen

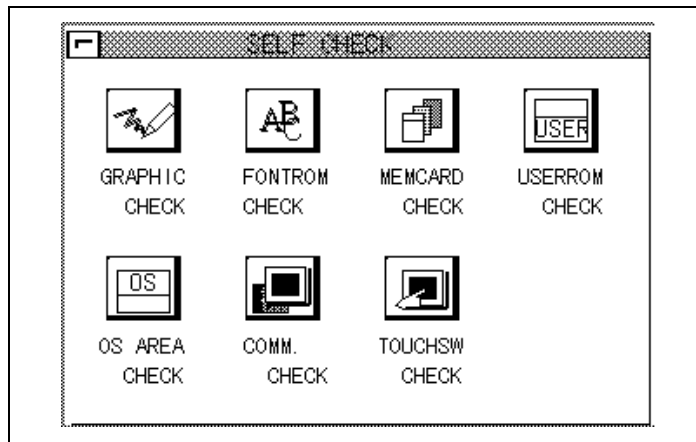

(2) Features

Diagnostic checks on GOT hardware include the following options:

- Graphic Check.....Allows you to perform visual inspection on screen display for discoloration and lack of display.
- Fontrom Check.....Allows you to perform visual inspection for deformation in font size.
- Memcard CheckAllows you to make a check on the hardware of a memory card. After checking, a memory card are initialized.
- Userrom CheckAllows you to check for user space in the internal memory. The password must be entered to check the user area of the built-in memory. The password is "1111" (fixed). (The entered password is displayed as "*****" on the screen.) After checking, user space is cleared to delete any data contained in the user space.
- OS Area CheckAllows you to check for OS space in the internal memory.
- Comm. Check.....Allows you to check for GOT-to-PLC CPU communications.
- Touchsw Check.....Allows you to check for touch keys.

The GOT performs these checks.

(3) Procedure

(a) Basic operation

- Select the desired button to perform a diagnostic check.
- Select options as instructed on-screen.
- You will see a message indicating that the selected diagnostic check was successfully completed.
- If an error is detected, you will see a message indicating the occurrence of the error.
- The Image Check allows you to view the following elements:
 - 1) The entire screen is displayed in one color. Display colors are changed in the order of red-green-blue.
 - 2) Basic figures are displayed, including circles and squares.
 - 3) Ellipses and checkered patterns are tiled or cascaded on-screen.

4.7 Displaying GOT memory information (memory information)

(1) Display screen

Sample screen

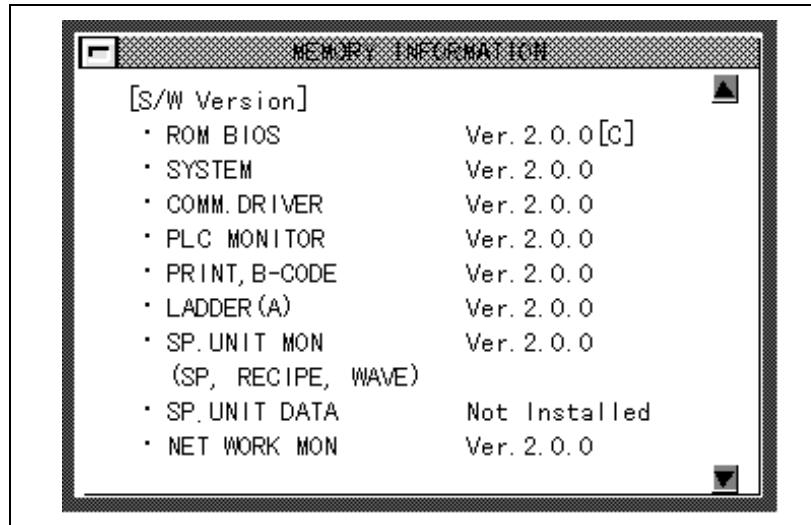

(2) Features

The contents of GOT memory information include:

- OS version number
- Status of communications with the PLC CPU
- Available space in the internal memory
- Availability of memory cards and available space in a memory card
- Availability of the ladder monitor function

(3) Procedure

(a) Basic operation

Touch ▲ ▼ to scroll screens.

(b) To return to the Utility Menu screen

Touch □ to return to the Utility Menu screen.

4.8 Setting the Clock (Clock)

(1) Display screen

Sample screen

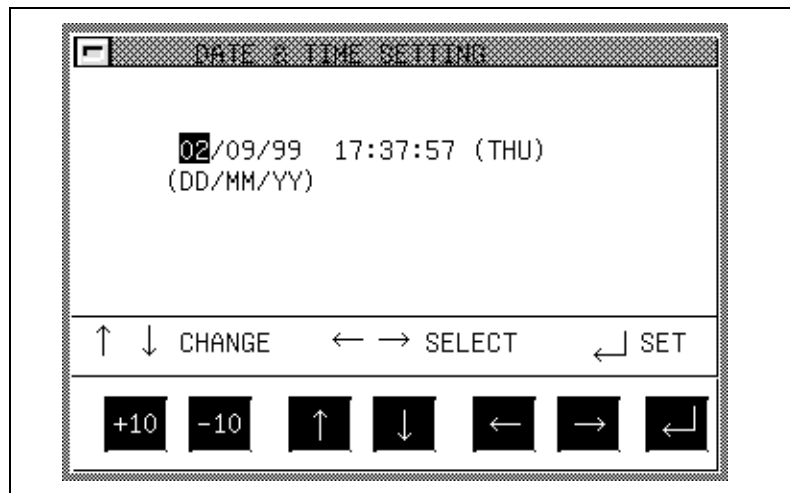

* The time when the Clock Settings screen was displayed is shown in the window panel. The time indicator in the upper-right corner of the screen shows the current time. After correcting the date or time, check the clock for the current time.

(2) Features

- The date, time, and a day of the week can be set to adjust the clock of the PLC CPU and the A9GT-RS2T.

(3) Procedure

(a) Basic operation

- Touch to select the desired option.
- Touch or to change numeric values.
- Touch or to to change the numerical values in increments of 10.
- Touch to set the clock of the PLC CPU.

(b) To return to the Utility Menu screen

- Touch to return to the Utility Menu screen.

POINTS

- Adjust the clock when you start up the system.
- The clock cannot be properly adjusted while reading or writing clock data by running sequence programs on the PLC CPU side (or when M9028 is turned on by sequence programs in the case of the ACPU).
- This option is not selectable from the Utility Menu screen when connected to the PLC CPU that has no clock function.
- This option is not selectable when the A9GT-RS2 is used for microcomputer connection.
- For MELSECNET/10 connection, the function is unavailable when the connection target CPU is the Q00JCPU, Q00CPU or Q01CPU.

4.9 Displaying the display area cleanup screen (screen cleanup)

(1) Display screen



(2) Features

- A black screen is displayed when cleaning up the display area. This makes the screen easy to view.

(3) Procedure

(a) Basic operation

- Touch the upper right and left corners of the screen at the same time to return to the Utility Menu screen.

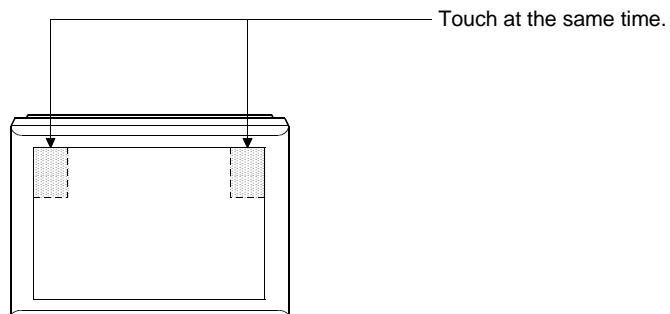



4.10 Changing security levels (security password)

(1) Screen display









(2) Features

- If objects (numeric input or touch keys, etc.) are secured by using GT Designer, their security levels can be changed by entering a password.
- If the characters entered match a password, a message appears on-screen, telling that the security levels have been properly changed. Touching  will return to the Utility Menu screen.
- If the characters entered do not match a password, an error message appears on-screen. Touching  will return to the Utility Menu screen.
- Numerical numbers and alphabets [A] to [F] can be used for a password.
- Details about security levels, see GT Works Version5/GT Designer Version5 Reference Manual

(3) Procedure

(a) To enter a password, follow these steps:

- Touch  to  and  to  to enter a password.
- Touch  to confirm the password entered.
- To correct the password entered, touch  to delete wrong characters and enter correct characters again.

(b) To quit entering a password:

- Touch  to return to the previous monitor screen.

4.11 Controlling limited access to the utility menu (password)

(1) Screen display



(2) Features

- Password protection can be set on the GOT by using GT Designer. If access to the Utility Menu screen is password-protected, a screen asking you to enter a password is displayed when you touch the upper right and left corners of the screen or when you touch a touch key on the screen. A dialog box for defining a password is contained in the common settings menu of GT Designer.
- If the characters entered match a password, the Utility Menu screen appears.
- If the characters entered do not match a password, an error message appears on-screen. Touching **Exit** will return to the previous monitor screen.
- Numerical numbers and alphabets **A** to **F** can be used for a password.

(3) Procedure

(a) To enter a password, follow these steps:

- Touch **0** to **9** and **A** to **F** to enter a password.
- Touch **Enter** to confirm the password entered.
- To correct the password entered, touch **DEL** to delete wrong characters and then enter correct characters again.

(b) To quit entering a password:

- Touch **Exit** to return to the previous monitor screen.

4.12 Adjusting the brightness of the monitor screen on the dedicated screen (Brightness adjustment)

(1) Display screen

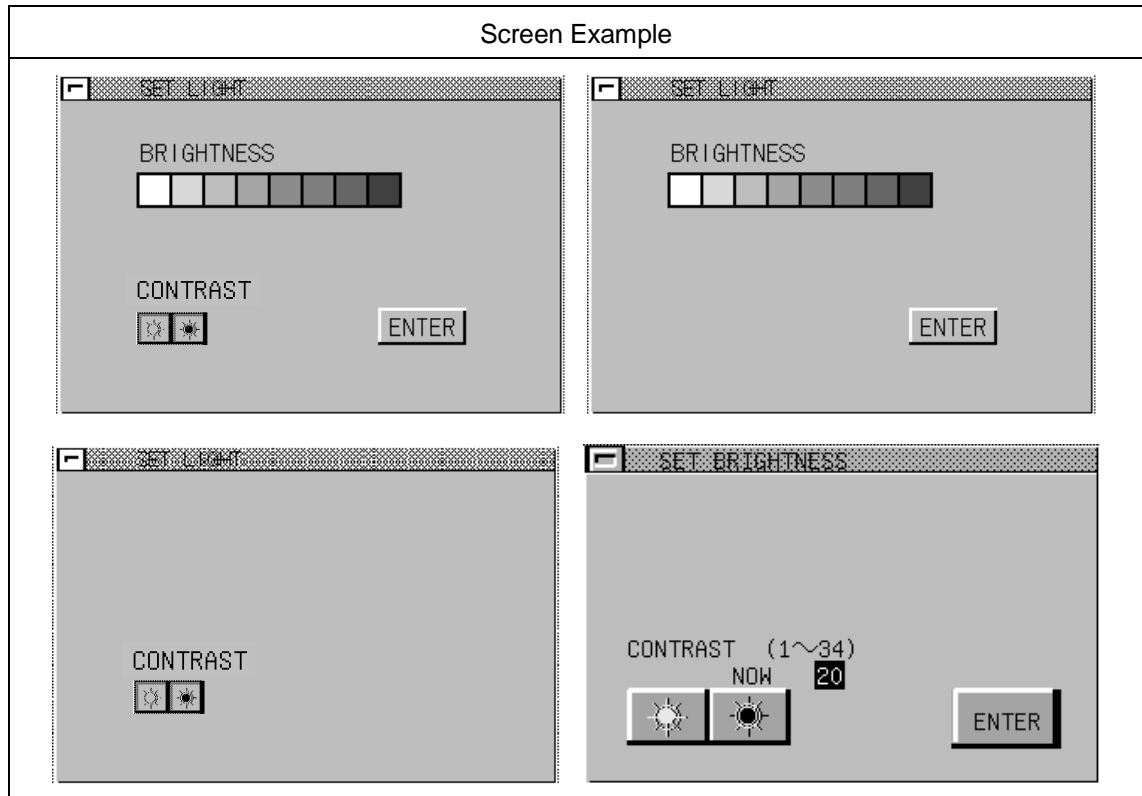

(2) Function

- Used to adjust the brightness of the monitor screen.

(3) Operation

(a) Basic operation

- Touch any of to to select the brightness.
- Touch and at top of the screen to make contrast adjustment.
You can adjust the contrast in about 20 steps.
- Touch to store the settings into the GOT.

(b) Return to the utility menu screen

- Touching returns to the utility menu screen.

POINT

Some GOTs display the brightness adjustment switch on the screen though they cannot use the brightness adjustment function.

The brightness adjustment switch can be hidden in the following method.

(1) Corresponding GOTs

Type : A975GOT-TBA, A970GOT-TBA

Serial number : 9806AA to 9807AA

Confirm the serial number in the DATE field of the product rating plate.

(2) Method

Install the system programs into the GOT.

Install all system programs (except ROM_BIOS) that have been installed into the target GOT. The system programs installed in the GOT can be confirmed in the following method.

1) Confirmation on the GOT

You can confirm the system programs in the memory information of the utility function.

2) Confirmation from GT Designer

You confirm the system programs in the built-in memory information of GT Designer.

Refer to Help of GT Designer for details of the built-in memory information.

CHAPTER5 OPERATION PROCEDURES FOR THE LADDER MONITOR FUNCTION

The operation procedures to follow when using the ladder monitor function are explained in the following section.

5.1 Operation procedures before starting ladder monitoring

This section contains a summary of the procedures for transmitting the system program (OS) for the ladder monitor function from the personal computer to the GOT until it is installed in the built-in memory.

For details, please refer to the Help in GT Designer. Details of the screen display and key operation are shown in the Help.

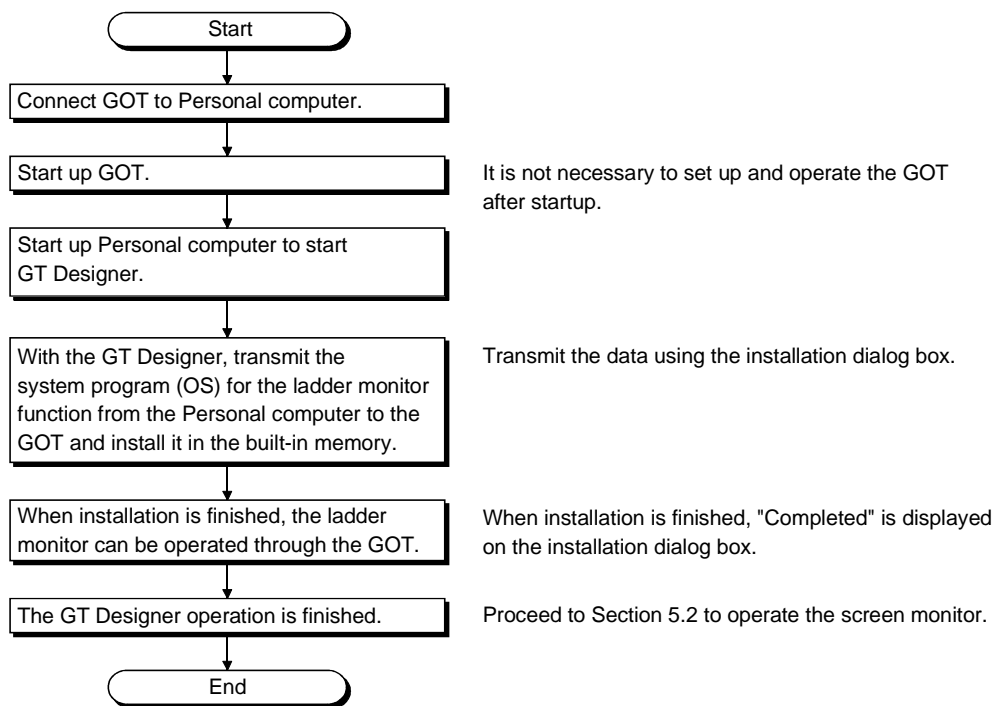

5.2 Operation procedures from display of user-created monitor screen to start of ladder monitoring

This section shows the operation procedures for the GOT when starting each operation of the ladder monitor function after the ladder monitor function system program (OS) has been installed in the GOT built-in memory.

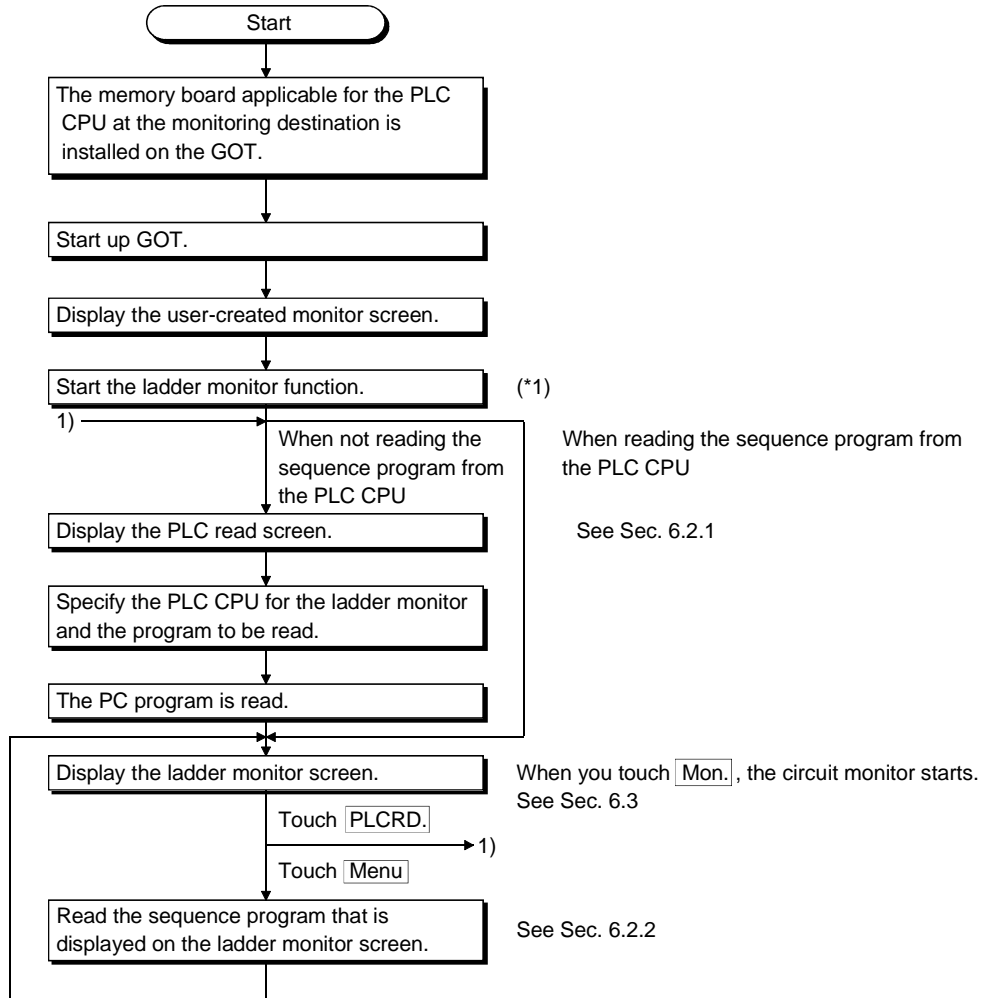

*1 The ladder monitor function can be started in either of the following two methods.
 Starting from the touch key Touch the touch key where the extension key (ladder monitor) has been set.
 Starting from the utility menu of the GOT Touch [LADDER MON.] in the utility menu.

5

CHAPTER6 OPERATING THE VARIOUS LADDER MONITOR SCREENS

The following sections describe each screen operation when using the ladder monitor function.

The screens used for explanations in this chapter are mainly those of the A975GOT. The ladder monitor display screen varies slightly with the GOT used. Refer to Section 6.1 for differences between the display screens.

6.1 Display screens

The ladder monitor display screen varies with the used GOT and target PLC CPU.

(1) MELSEC-A/FX ladder monitor

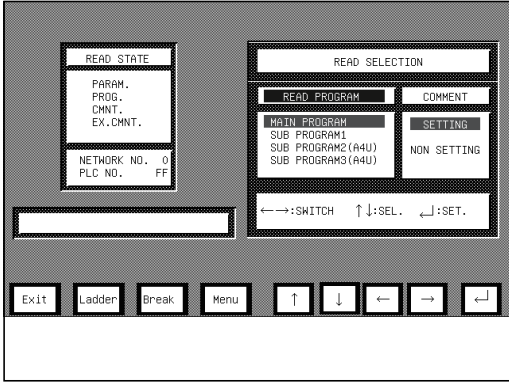
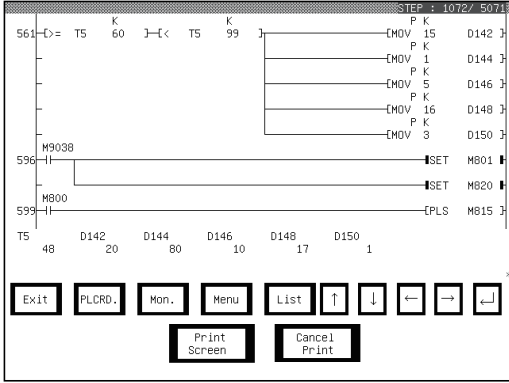
<p>Used GOT</p> <p>A985/A97*/960GOT</p>	<p>PLC read screen</p> 	<p>Ladder monitor screen</p>  <ul style="list-style-type: none"> • Sequence program : Max. 8 lines (1 line: Max. 11 contacts) displayed • When the display screen type is the EL, the [Print Screen] and [Cancel Print] keys are not displayed.
---	---	--

(2) MELSEC-QnA ladder monitor

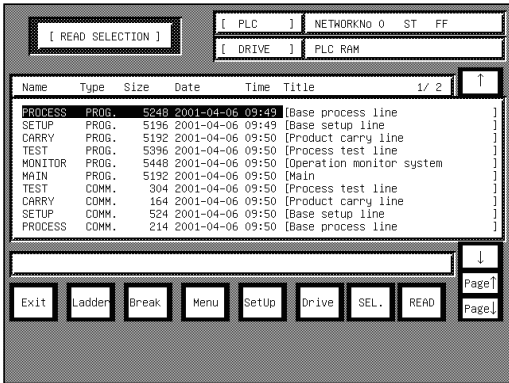
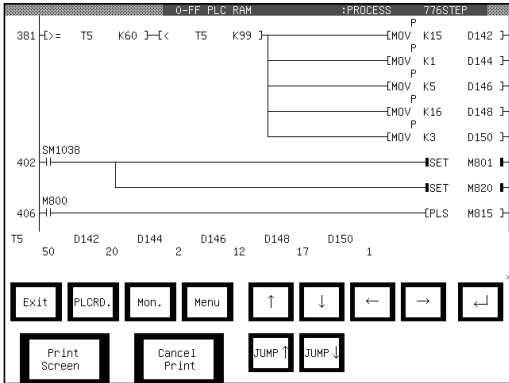
<p>Used GOT</p> <p>A985/A97*/960GOT</p>	<p>PLC read screen</p> 	<p>Ladder monitor screen</p>  <ul style="list-style-type: none"> • Sequence program : Max. 8 lines (1 line: Max. 11 contacts) displayed • When the display screen type is the EL, the [Print Screen], [Cancel Print], [JUMP ↑] and [JUMP ↓] keys are not displayed.
---	--	---

(3) MELSEC-Q ladder monitor

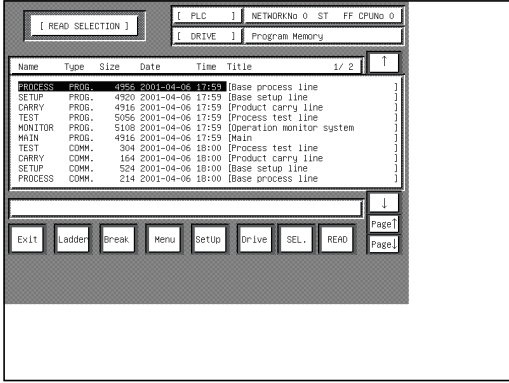
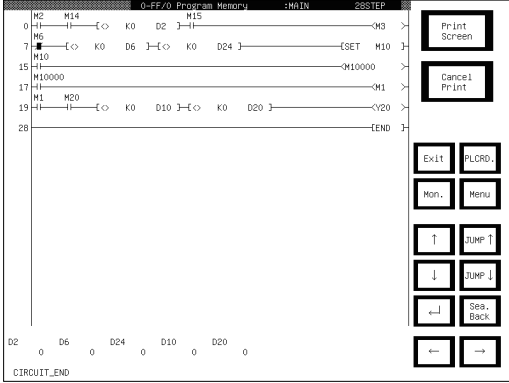
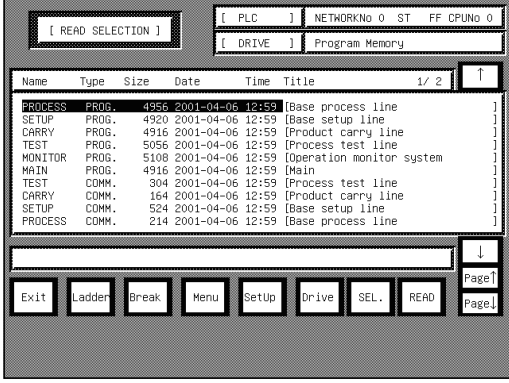
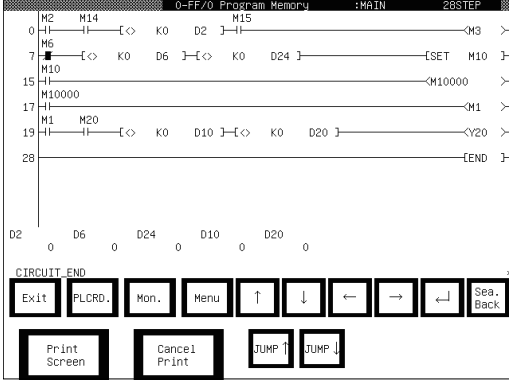
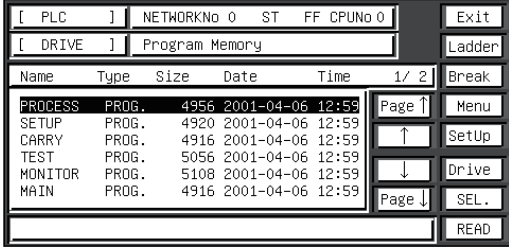
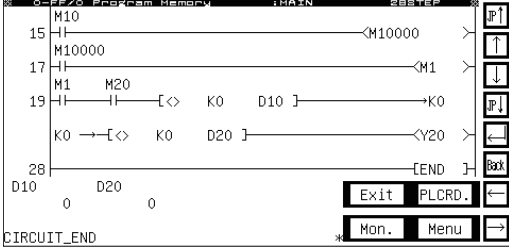
Used GOT	PLC read screen	Ladder monitor screen
A985GOT		 <ul style="list-style-type: none"> • Sequence program : Max. 15 lines (1 line: Max. 11 contacts) displayed
A97*/960 GOT		 <ul style="list-style-type: none"> • Sequence program : Max. 8 lines (1 line: Max. 11 contacts) displayed • When the display screen type is the EL, the [Print Screen], [Cancel Print], [JUMP ↑] and [JUMP ↓] keys are not displayed.
A956WGOT	 <ul style="list-style-type: none"> • Headings are not displayed in the file list. 	 <ul style="list-style-type: none"> • Sequence program : Max. 5 lines (1 line: Max. 7 contacts) displayed • The [Print Screen] and [Cancel Print] keys are not displayed.

6.2 Screen operation and screen changes when monitoring

This section includes an explanation of the PLC read operation that reads out the sequence program from the PLC CPU when executing the ladder monitor, the ladder read operation that specifies the sequence program to be displayed on the ladder monitor screen, and the screen movement when executing the ladder monitor.

6.2.1 Reading data from the PLC

The operation of reading the sequence program for the ladder monitor from the PLC CPU is described below.

The operation procedures vary depending on the PLC CPU to be monitored.

All of the keys used with the operation are touch keys displayed on the screen.

Touch the position where the object key is displayed and enter the data.

(1) When the MELSEC-A/FX ladder monitor is executed

[Operation procedure]

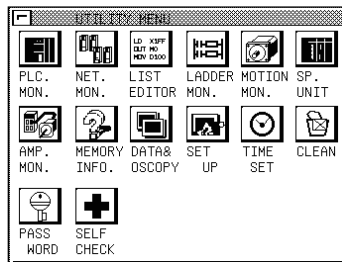

1) Touch the ladder monitor starting touch switch on the monitor screen prepared by the user or touch the **LADDER MON.** on the utility screen to start the ladder monitor function.

LADDER MON. (Touch)

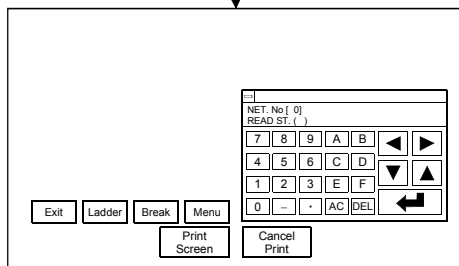

To the following page

2) Specify the network No. and station No. for the object PLC CPU.

(For data link system, CC-Link system)

NET NO : 0
 READ ST. : FF (Own station)
 0 (Master station)
 1 to 64 (Local stations)

(For network system)

NET NO : 1 to 255 (Host Net)
 0 (Master station)
 READ ST. : FF (Own station)
 1 to 64 (Control station)
 1 to 64 (Normal station)

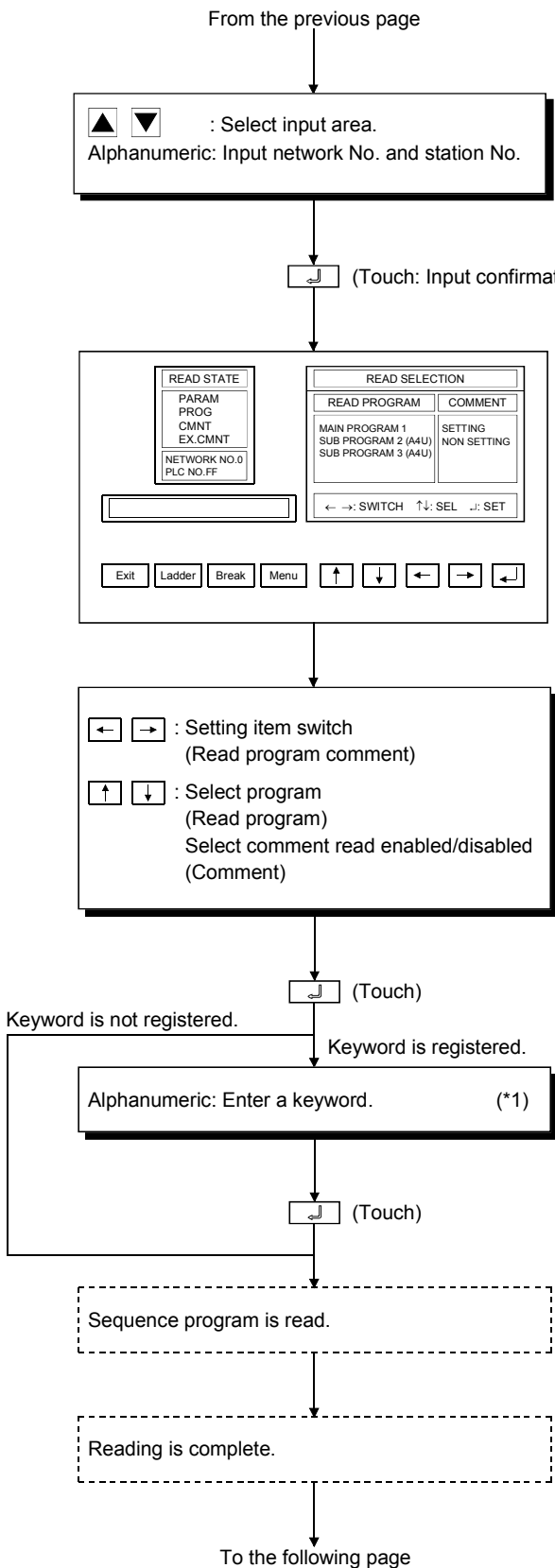

3) In "Read Selection", specify the sequence program to be read from the object station. Specify whether or not to perform comment read.

4) Input the keyword that is registered to that station. If no keyword has been registered, nothing has to be entered.

5) The contents and capacity of the read procedure are displayed. When you touch **Break**, the read procedure is interrupted. When reading resumes, it starts at the beginning.

6) "Completed" is displayed.

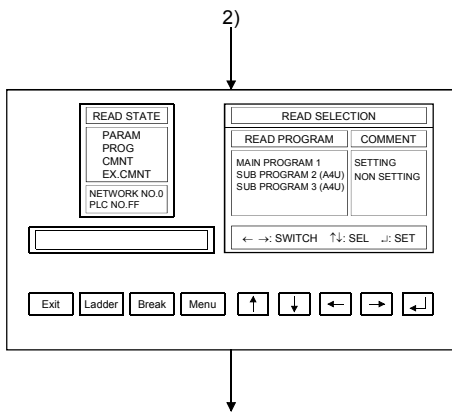

Change screen.

- Exit** : Moves to screen where ladder monitor function starts.
- Ladder** : Moves to ladder monitor screen.
- PLCRD.** : Moves to PLC read screen.

*1 Data being entered can be cleared by the following keys.

- AC** : Clears all data being entered to the object area.
- DEL** : Clears one character at the cursor position.

POINT

Once this data has been read from the PLC, it does not need to be read again. If data for screens created by the user is downloaded from the computer after this data has been read, however, the data will have to be read again.

(2) When the MELSEC-Q/QnA ladder monitor is executed

[Operation procedure]

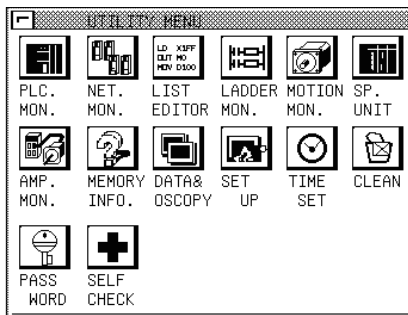

- 1) Touch the ladder monitor starting touch switch on the monitor screen prepared by the user or touch the **LADDER MON.** on the utility screen to start the ladder monitor function.

POINT

If ROM_BIOS is not installed, an error message is displayed. Touch the **END** button and install the ROM_BIOS (H version or later).

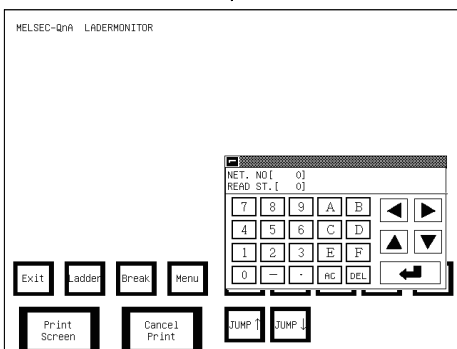

- 2) The key window is displayed. Set the network No./station No. /CPU No.*1 of the applicable PLC CPU with the following keys.

- : Select the input area.
- Alphanumeric** : Input the network No. and the station No.
- AC** : Clear all input data to the applicable area.
- DEL** : Clear one character at the cursor position.
- : Define the input.

POINT

Designate the network No./ the station No. and CPU No.*1 of the applicable PLC CPU.

(For CC-Link system)
 Network No. : 0
 Station No. : 0 (mask station)

(For network system)
 Network No. : 1 to 255 (self-loop)
 Station No. : 1 to 64 (control station)
 1 to 64 (normal station)

(For Ethernet connection)*2
 Network No. : 1 to 239
 Station No. : 1 to 64

(For multi-CPU system)
 CPU No. : 0 to 4 (CPU number)

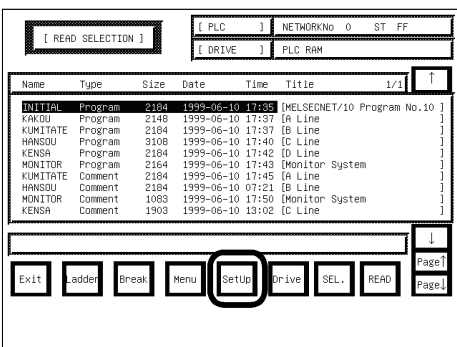

- *1 Displayed for MELSEC-Q ladder monitor only.
- *2 The monitor target must be preset using GT Designer. For MELSEC-A ladder monitor, specify the network number/station number set on GT Designer. Refer to the help of GT Designer for details of the monitor target setting for Ethernet connection.

- 3) The PLC read screen appears. First, touch the **Set Up** key to display the setting window.

To the following page

From the previous page

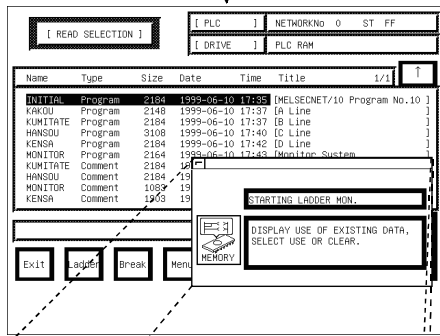

- 4) The setting window appears.
 Make the setting for initial ladder monitor start.
 Touching the **MEMORY** key changes the setting choice as indicated below.

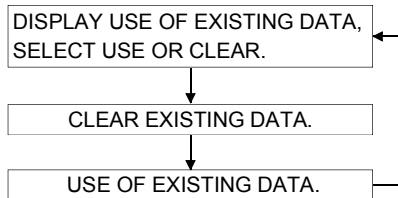

After the setting is over, touch the button.

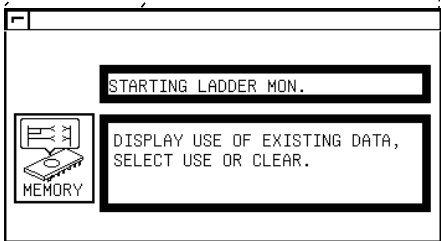

- 5) Then, touch the **Drive** key to select the drive (applicable memory) which stores the applicable ladder data to be monitored.

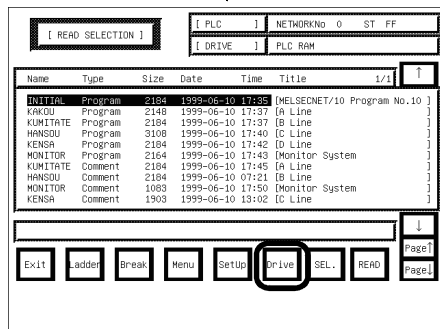

To the following page

From the previous page

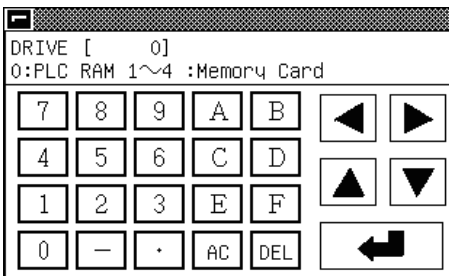

6) The Drive Selection Window is displayed. Select the drive (applicable memory) with the following keys.

- to : Input the drive number.
- : Clear all input data on the drive.
- : Define the input.

7) The file list of the selected drive is displayed. Select the ladder to be read with the following keys.

- : Move the cursor upward.
- : Move the cursor downward.
- : Display the previous page.
- : Display the next page.
- : Move the cursor and touch the key to change select (*)/cancel.
- : Start reading the selected ladder.

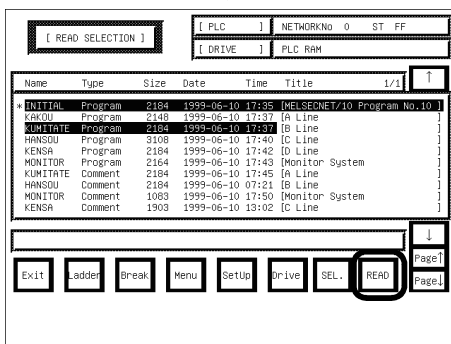

POINT

- MELSEC-Q ladder monitor
When a password is registered at the PLC CPU, a file password window is displayed at the start of reading. Input the password. (It does not have to be input if it is not registered.)
- MELSEC-QnA ladder monitor
When a keyword is registered at the PLC CPU, a key window is displayed at the start of reading. Input the keyword. (It does not have to be input if it is not registered.)

8) Contents and capacity of the reading process are displayed.

Touch to stop the reading process.

To read the ladder again, start from the beginning.

9) When the message "Completed" is displayed, reading is completed. Change the screen with the following keys.

- : Move to the screen when the ladder monitor is started.
- : Move to the ladder monitor screen.
- : Start from setting window (2) for the network No./station No.

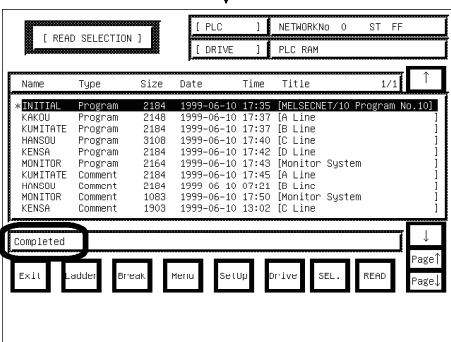

POINT

Once PLC reading is performed, operations for PLC reading are not required from the next time onward.

6.2.2 Ladder read operation

This section describes the object sequence program of the ladder monitor that is read from the PLC CPU, for the operation displayed on the ladder monitor screen.

[Operation procedure]

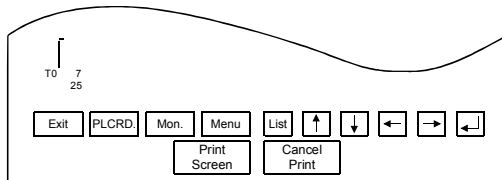

* When there is a  at the upper left of the screen, touch it to return to the original screen.

MENU (Touch)

When the screen below is currently displayed, it is not necessary to touch this.

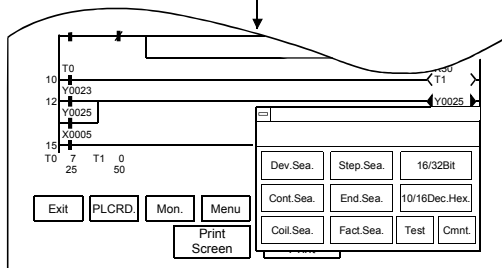

The ladder read operation is executed.

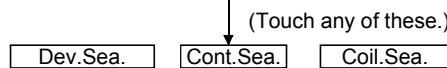

When specifying and reading the device, contact point or coil used in the program (*4)

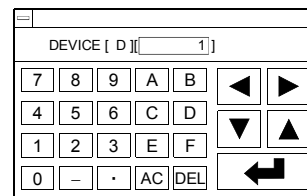
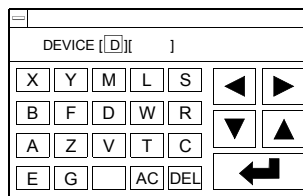

(When entering device name)

(When entering device No.)



  : Select input area.
Alphanumeric: Enter device name and device No. (*1)

1)



Move to ladder monitor screen (*2)

(Touch: Input confirmation)

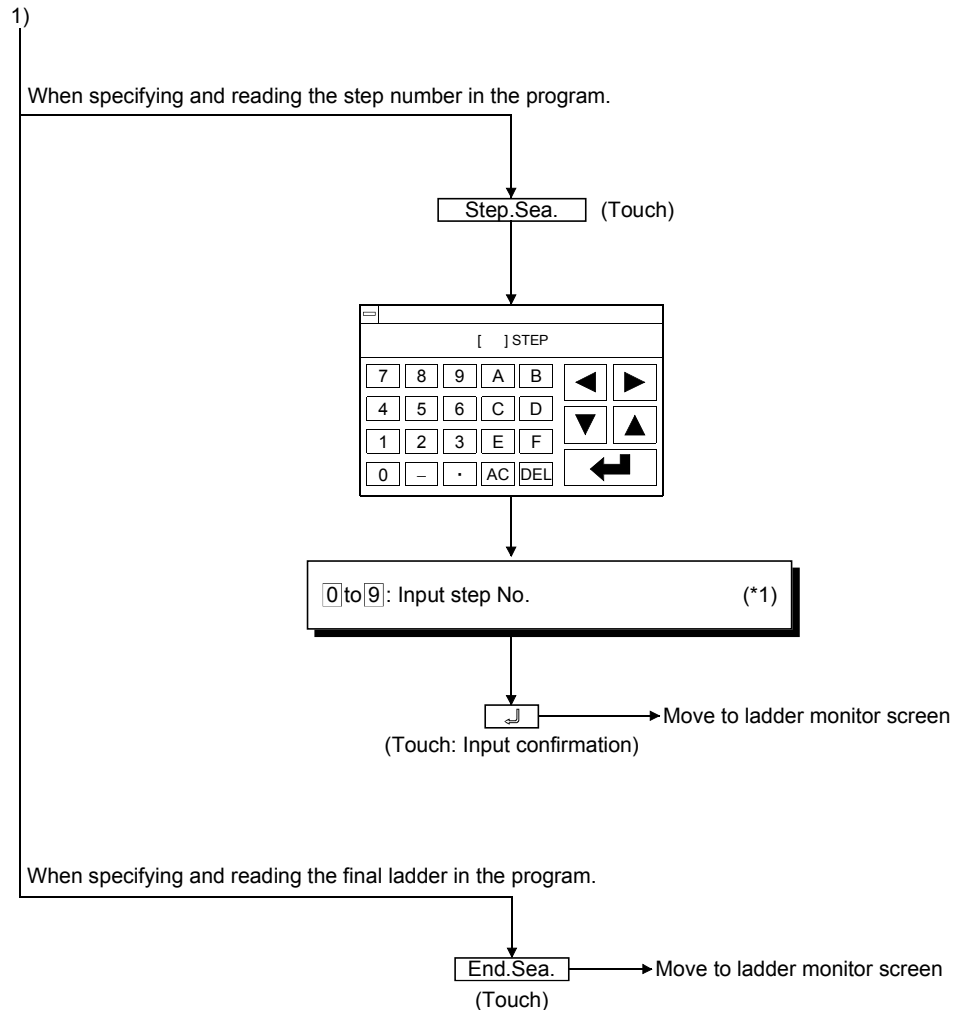

*1 Data being entered can be cleared by the following keys.

AC : Clears all data being entered to the target area.

DEL : Clears one character at the cursor position.

*2 When specifying and reading a device, contact point or coil used in the program, the search targets all programs starting from the step number displayed on the previous ladder monitor screen, to the program immediately previous to the one displayed.

After moving to the screen monitor screen, continuous reading by the same device is enabled by touching **↵** on the screen.

If you touch any other key but **↵**, the continuous read function is canceled.

*3 When device search, contact point search, or coil search is performed during ladder monitoring, only the ladder block which includes the read search device is displayed.

Example) 1) When the device name to be searched is entered as "X0001"

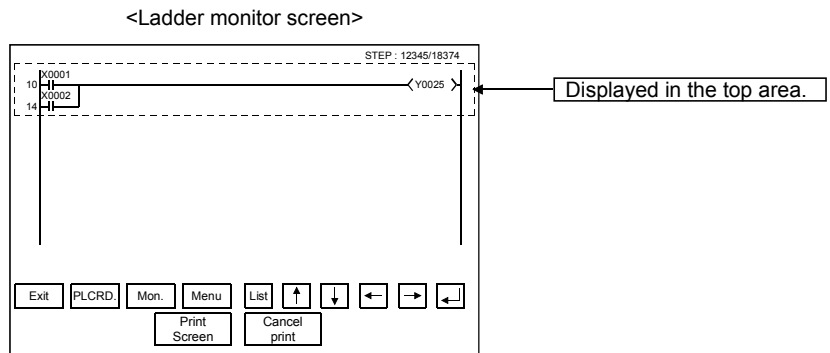

2) When the same search is repeated

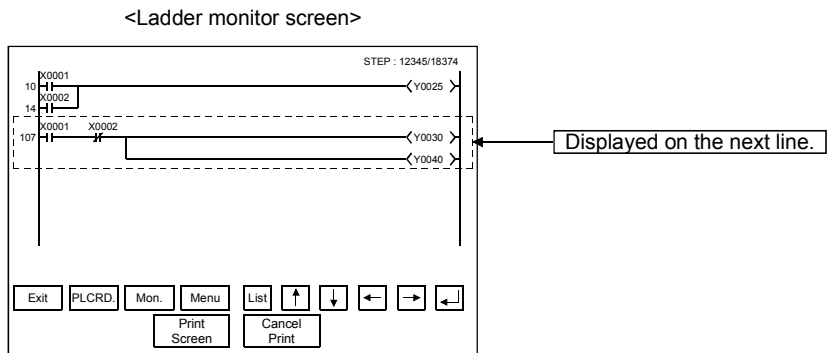

*4 Please note that the indirect specification device (index register (z)) cannot be specified and read while the MELSEC-QnA ladder monitor is executed.

6.2.3 Using the defect search

The defect search enables you to examine a ladder block that caused a failure. It helps you to search from the ladder block backward so that you can determine why any coil was turned ON or OFF during the ladder monitoring, or whether its contact is conductive or nonconductive.

POINT

While the MELSEC-QnA ladder monitor is performed, the factor search function cannot be used.
(The touch key of **Fact.Sea.** is not displayed.)

[Operation procedure]

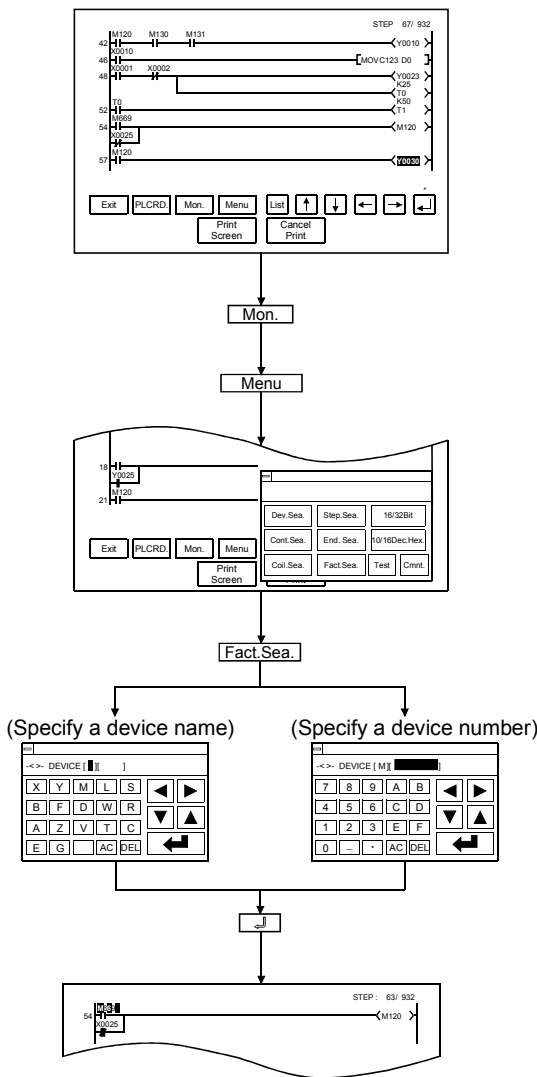

- (1) Search for and display a ladder block where a failure occurred.
Example: When a valve connected to Coil Y0030 does not operate properly, begin searching for Coil Y0030 and view its ladder block on the screen.

- (2) Touch **Mon.** to start the ladder monitoring.

- (3) Touch **Menu** and then select **Fact.Sea.** from among options that appear on-screen.

If you touch **Fact.Sea.** without executing the ladder monitor function, operation changes depending on the type of the ladder monitor used.

For MELSEC-A ladder monitor: The "No MONITORING" message appears and the following operation cannot be performed.
(Operation is enabled after execution of monitor.)

For MELSEC-Q ladder monitor: Monitor is executed automatically and the following operation is enabled.
After termination of a defect search, monitor stops automatically with the search result retained.

- (4) Another dialog box where you can specify a device name or device number is displayed on-screen. Specify any contact of which coil is not turned ON as a search device.
Example: Specify "M120" as the search device.

: Used to select a data entry field.
 Alphanumeric : Used to enter a device name or device number.*1
 : Used to stop the defect search, returning to the ladder monitor screen.

*1 Use the following touch keys if you want to delete any data entry:

: Clears all the data entered in a specific field.

: Clears one character at the cursor position.

- (5) Start searching for a device that caused a failure and view search results on the ladder monitor screen. Search from the last step number backward as displayed on the ladder monitor screen.

Please note that any touch keys other than **Esc** and **Exit** are enabled until the defect search is completed.

[Search results]

Search results reveal any occurrences of the search device. They are useful when you determine whether a defective device is conductive or nonconductive. If any occurrence of the search device is not found as a result of the search, a message appears on-screen, telling that "PROGRAM NOT FOUND."

(1) When an occurrence of the search device is found:

If an occurrence of the search device is found as a result of the search, the search for another defective device will automatically be started.

Example: After searching for Device M120 that is in the OFF state, "M669" will be displayed as a device that caused a failure.

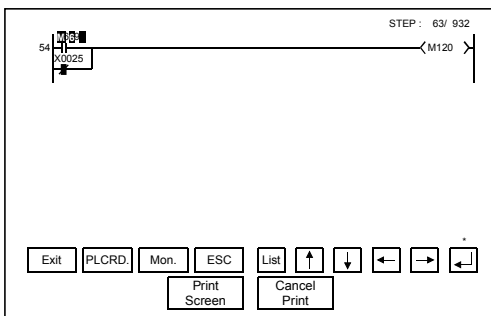

After searching for Coil M120 that is in the OFF state, "M669" is displayed as a device that is not conductive.

Example: **M669**

* After searching for a device that is in the ON state, a device that is conductive is displayed. The entire field of the device name and number is highlighted on-screen.

Example: **M669**

After searching for Coil M669 that is in the OFF state, "M111" is displayed as a device that is not conductive.

Example: **M111**

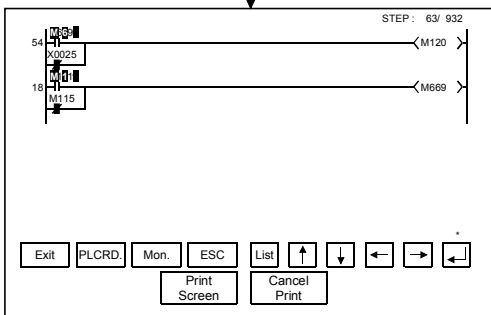

A search for another defect is repeated.

(2) When two occurrences of the search device are found.

If there are two or more devices that caused a failure, the "the defect search is interrupted" message appears and the defect search is terminated.

Example: After searching for Device M120 that is in the OFF state, "M669" and "X0025" will be displayed as devices that caused a failure.

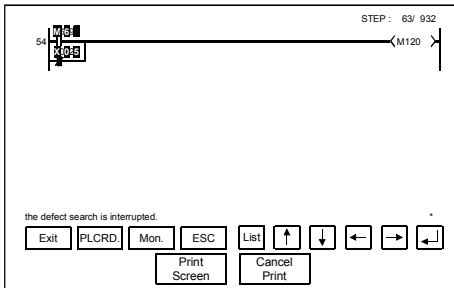

After searching for Coil M120 that is in the OFF state, "M669" and "X0025" are displayed as devices that are not conductive.

Example: **M669**, **X0025**

* After searching for a device that is in the ON state, devices that are conductive are displayed. The entire field of the device name and number is highlighted on-screen.

Example: **M669**, **X0025**

When resuming the defect search, specify either of the found contacts M669 and X0025.

(After touching **Esc** to change it into **Menu**, execute the defect search.)

(3) Precautions for making defect search

(a) If a B-contact is found defective as a result of the defect search, a search for the cause of the ON/OFF state will be automatically switched.

(b) After the end of the defect search, the GOT stops monitor and displays the search result.

Hence, the monitor screen of the GOT shows the result retained during the defect search.

(c) While the search result is displayed after the end of the defect search, the searched ladder can be displayed backwards by pressing (single ladder block scroll) or (10 ladder block jump (available for only the MELSEC-Q ladder monitor function)).

Up to 100 ladders can be displayed on-screen. The following messages will appear at the start or the end of the search results.

- When viewing the start of search results: "This is the start of search results."
- When viewing the end of the search results: "This is the end of search results."

(d) The ON/OFF of the contact and coil is displayed as described below.

1) During automatic search execution

MELSEC-A ladder monitor: Displays ON/OFF in the entire ladder displayed on the screen.

MELSEC-Q ladder monitor: Displays ON/OFF in the ladder displayed last.

2) During search result display

The ON/OFF of the ladder block searched last and the monitor results of word devices are displayed.

(e) When the defect search starts, changes into .

Touch during the defect search to stop the defect search and display the search result.

Further, touch to change into and display the normal ladder.

(f) The screen during the defect search operates as described below.

1) If the display data exceeds one screen during the defect search

The screen is scrolled automatically.

2) If the ladder step searched during the defect search exceeds one screen

MELSEC-A ladder monitor: The screen is scrolled automatically to the last line of the ladder step.

MELSEC-Q ladder monitor: The screen is not scrolled automatically to display the ladder step.

(g) Touching can stop the defect search. Search results are continuously displayed on-screen until is touched.

The ladder step searched last is displayed as described below.

- MELSEC-A ladder monitor: ON/OFF display is not provided.
- MELSEC-Q ladder monitor: ON/OFF display is provided.

6.2.4 Touch search operation

A touch search is the function designed to search for the coil of a device when its contact displayed in the ladder monitor is touched and to search for the contact of a device when its coil is touched.

A search can be made from the beginning of a ladder to its last step.

This function is always valid when a normal ladder is displayed.

POINT
<ul style="list-style-type: none"> • The touch search function cannot be used when MELSEC-A/FX/QnA ladder monitor is executed. • The function cannot be used for instructions other than contacts and coils and for word devices. • When the defect search function is in use, the touch search function cannot be used. (Touch [Esc] to terminate the defect search.)

[Operation procedures (when contact is touched to search for coil)]

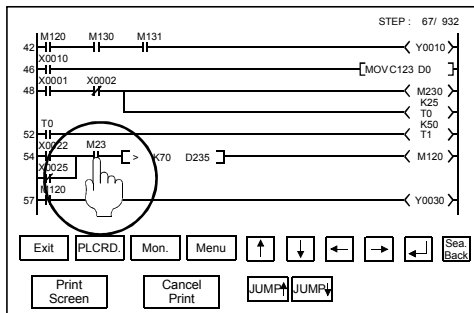

(1) Touch the contact on the ladder monitor screen.

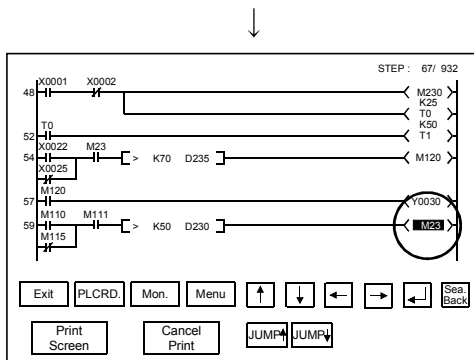

(2) The coil of the device whose contact was touched is searched for, and the single ladder block including the coil found is added to the display. (The found device is highlighted.)

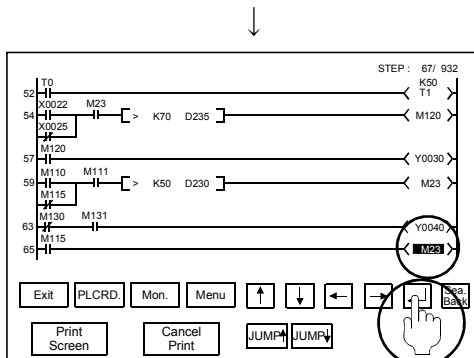

(3) Touch **[Sea/Back]** to search the ladder downward continuously.

[Operation procedures (when coil is touched to search for contact)]

(1) Touch the coil on the ladder monitor screen.

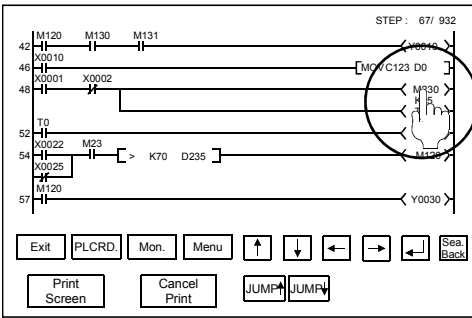

(2) The contact of the device whose coil was touched is searched for, and the single ladder block including the contact found is added to the display.
(The found device is highlighted.)

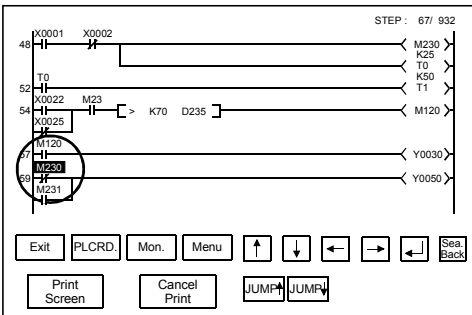

(3) Touch  to search the ladder downward continuously.

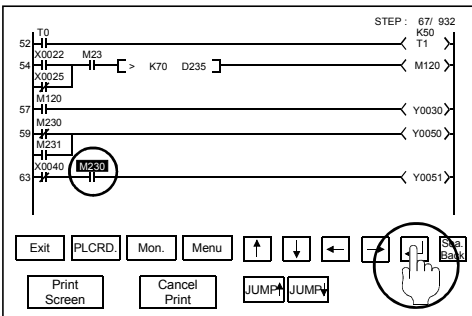

6.2.5 Changing from one screen to another

This section describes the screen movements when executing the ladder monitor from the status where the user-created monitor screen is displayed.

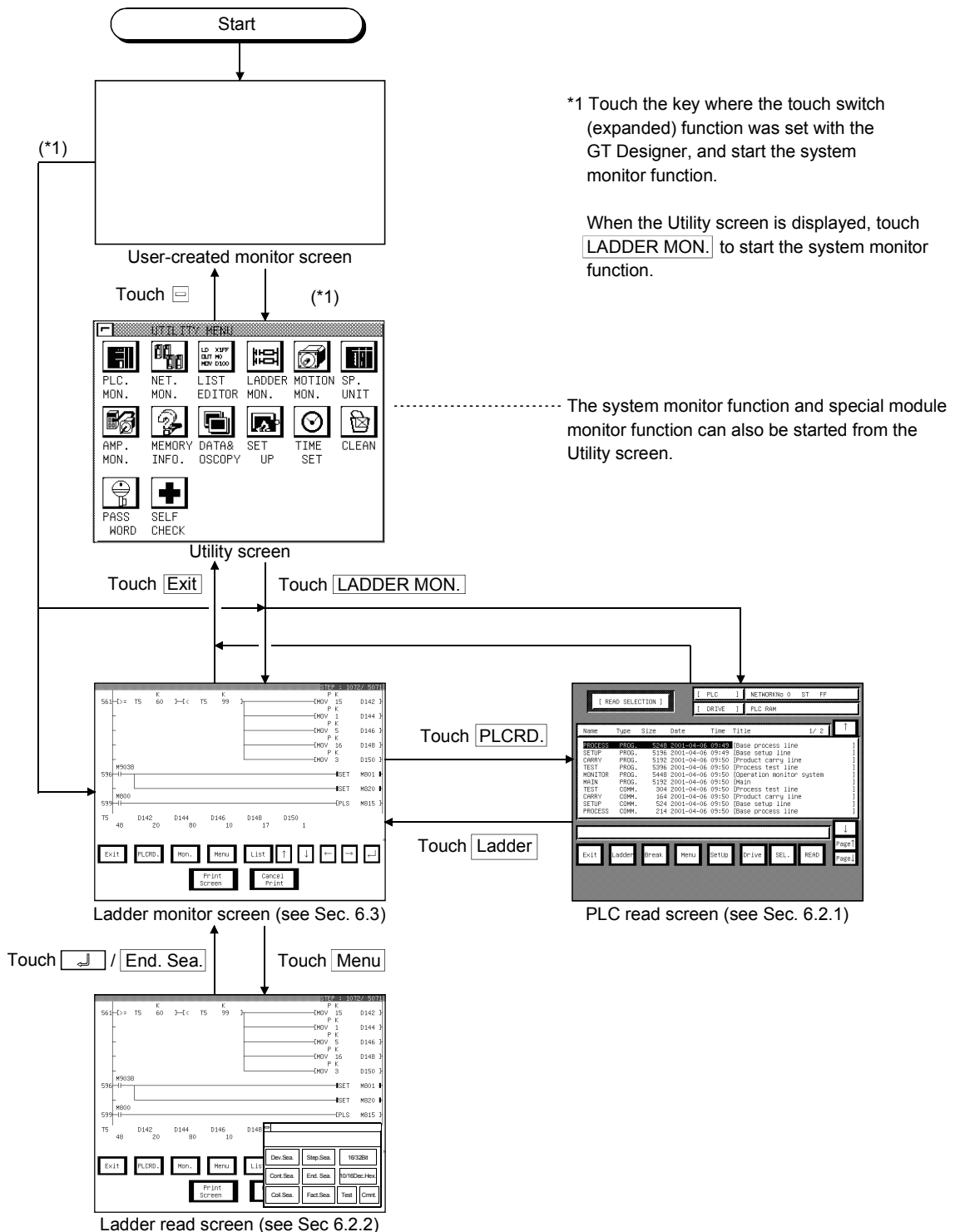

6.3 Ladder monitor

The ladder monitor screen display and the keys that are shown at the top of the screen are explained in this section.

6.3.1 Ladder monitor screen display and key functions

The ladder monitor screen varies depending on the type of PLC CPU to be monitored.

POINT
 After executing PLC read, if the PLC CPU comment or comment capacity is changed, the comment may not be correctly displayed on the ladder monitor screen. When changing the comment or comment capacity, re-start the GOT.

(1) When MELSEC-A/FX ladder monitor is executed

(a) Display

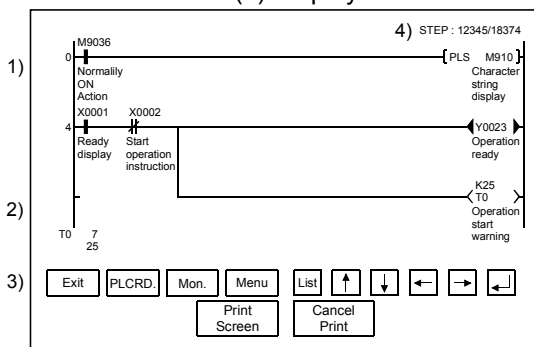

When comment is not displayed : maximum 8 lines
 When comment is displayed : maximum 3 lines

ON/OFF status display for ladder monitor

- ON status
- OFF status

* The MCR command is normally displayed as

1)	Sequence program is displayed. A maximum of 11 contact points is displayed in one line of a ladder; for 12 contact points or more, move to the next line. When a comment display is specified, a comment is also displayed; expanded comments are given priority (For the method of displaying comments, see Sec. 6.3.3.).
2)	A maximum of eight devices is displayed for the word device current value, timer and counter current value (upper row), and set value (lower row). When the set value is an indirect specification, the value of the indirectly specified device is displayed. (To switch between decimal and hexadecimal for the displayed value, see Sec. 6.3.3.).
3)	Display the keys used with the operation on the ladder monitor screen shown in (b) (Touch input).
4)	The display step number (left) and the remaining step number (right) are displayed.

(b) Key functions

This table shows the key functions used with the operations on the ladder monitor screen.

Key	Function
	Return to screen where ladder monitor function starts.
	Move to PLC read screen to read sequence program being monitored from PLC CPU (PLC read).
	Move to ladder monitor menu screen, to specify sequence program to be displayed on ladder monitor screen (Ladder read).
	Start monitoring of sequence program that is displayed on ladder monitor screen.
	Activates the List editor function. (For details of the List editor function, see Chapter 19.)
	Switch display device when there are nine or more devices displaying current values and set values.
	Display one ladder; scroll up or down.
	When reading ladder with device specification, read next program with same device specification (see *2 in Sec. 6.2.2.).

(2) When MELSEC-Q/QnA ladder monitor is executed
(a) Display

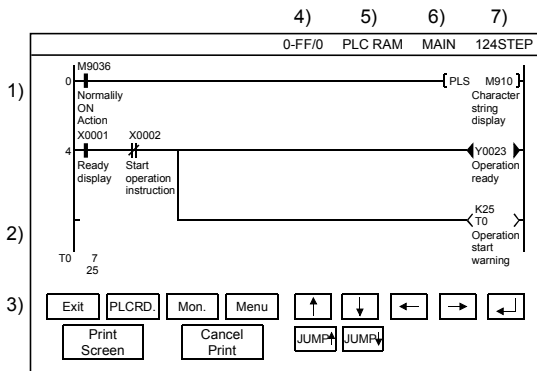

When comment is not displayed : maximum 8 lines
When comment is displayed : maximum 3 lines

ON/OFF status display for ladder monitor

- ON status
- OFF status

* The MCR command is normally displayed as

1)	Sequence program is displayed. A maximum of 11 contact points is displayed in one line of a ladder; for 12 contact points or more, move to the next line. *1 When a comment display is specified, a comment is also displayed; expanded comments are given priority (For the method of displaying comments, see Sec. 6.3.3.).
2)	A maximum of eight devices is displayed for the word device current value, timer and counter current value (upper row), and set value (lower row). When the set value is an indirect specification, the value of the indirectly specified device is displayed. (To switch between decimal and hexadecimal for the displayed value, see Sec. 6.3.3.).
3)	Display the keys used with the operation on the ladder monitor screen shown in (b) (Touch input). *2
4)	The network No., the station No. and CPU No. are displayed.
5)	The drive is displayed.
6)	The file name of the PLC program is displayed.
7)	The total number of steps in the current monitor PLC program is displayed.

*1 Depending on the GOT model, a display is provided on the MELSEC-Q ladder monitor screen as indicated below.









- A985GOT: Max. 15 lines displayed (1 line: Max. 11 contacts)
- A956WGOT: Max. 5 lines displayed (1 line: Max. 7 contacts)

*2 When the A985GOT or A956WGOT is used, the operation keys appear on the right side of the MELSEC-Q ladder monitor screen.

(b) Key functions

This table shows the key functions used with the operations on the ladder monitor screen.

Key	Function
	Return to screen where ladder monitor function starts.
	Move to PLC read screen to read sequence program being monitored from PLC CPU (PLC read).
	Move to ladder monitor menu screen, to specify sequence program to be displayed on ladder monitor screen (Ladder read).
	Start monitoring of sequence program that is displayed on ladder monitor screen.
	Switch display device when there are nine or more devices displaying current values and set values.
	Display one ladder; scroll up or down.
	When reading ladder with device specification, read next program with same device specification (see *2 in Sec. 6.2.2.).
	Displays the search history of the device/contact/coil search or touch search one place backward.
	Scrolls the display up or down by ten ladders.

POINT
<p>About the  key</p> <ul style="list-style-type: none"> • Immediately after the  key has been pressed to go back in the history, a continuous device search using the  key cannot be executed. • Using the  key, you can go back into the history up to 100 ladders. • When any of the following operations is performed, the search history is cleared to return to the normal ladder display. <ol style="list-style-type: none"> 1. When the   key is touched (When a single ladder block takes up more than one screen, scrolling can be made within the block.) 2. When the   key is touched 3. When a step search, END search or defect search is executed 4. When a comment display is changed 5. When a new ladder is read by touching .

6.3.2 Precaution during ladder monitoring

(1) When making connection to the FXCPU

- (a) The comment display is kana comments only.
- (b) During PLC read operation, the PLC read can only be performed for own station only.
- (c) STL (step ladder), the FXCPU exclusive instruction, is not a contact point, but treated as an instruction and displayed in the following manner:

When monitoring with the peripheral device for FX

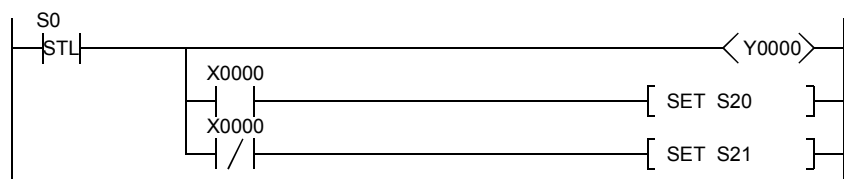

When ladder monitoring with GOT

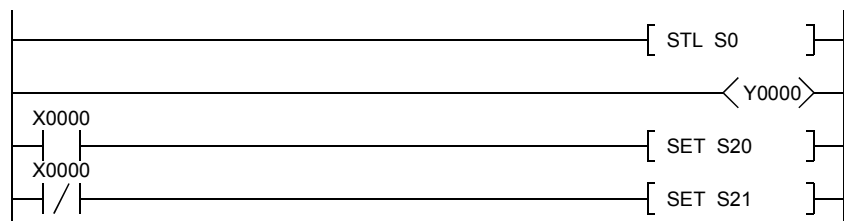

- (d) When searching for STL instruction, search for "S (state)" in the device search.

(e) The ladder data in which the following instructions are used cannot be displayed on the GOT.

Do not use the following instructions when executing the ladder monitoring on the GOT.

FNC No.	Instruction	FNC No.	Instruction	FNC No.	Instruction
External device SER		Clock operations		Data table processing	
87	RS2	164	HTOS	256	LIMIT
Floating point		165	STOH	257	BAND
112	EMOV	Other instructions		258	ZONE
116	ESTR	184	RND	259	SCL
117	EVAL	188	CRC	External device communication (inverter communication)	
124	EXP	189	HCMOV		
125	LOGE	Character string control		270	IVCK
126	LOG10	202	\$+	271	IVDR
128	ENEG	203	LEN	272	ICRD
133	ASIN	204	RIGHT	273	ICWR
134	ACOS	205	LEFT	274	IVBWR
135	ATAN	206	MIDR	External device communication (inverter communication)	
136	RAD	207	MIDW		
137	DEG	208	\$MOV	280	HSCT
Positioning		Data processing 3		Extension file register control	
150	DSZR	212	POP	290	LOADR
151	DVIT	213	SFR	291	SAVER
—	—	214	SFL	292	INITR
—	—	—	—	293	LOGR

(2) When making connection with the motion controller CPU

(a) When the OS version is "SV5***" in the SVST instruction, "J***" appears as the tag name of MC.

6.3.3 Switching the display form (decimal/hexadecimal) and turning the comment display on/off

You can switch the display form (decimal/hexadecimal) of the word device value or the timer/counter value that is displayed on the ladder monitor screen. You can also specify whether or not to display a comment for the object device.

1) Switching the display form (decimal/hexadecimal)

When monitoring, display the word device current value, the timer/counter current value (upper row) or the set value (lower row) in decimal or hexadecimal (When decimal is displayed, the display changes to hexadecimal.).

2) Switching the comment display on and off

Display the comment that is written in the object PLC CPU (When no comment is displayed, this turns on the comment display). Comment display priority order: expanded comment > Japanese character comment or Japanese kana comment

The display change operation is explained below.

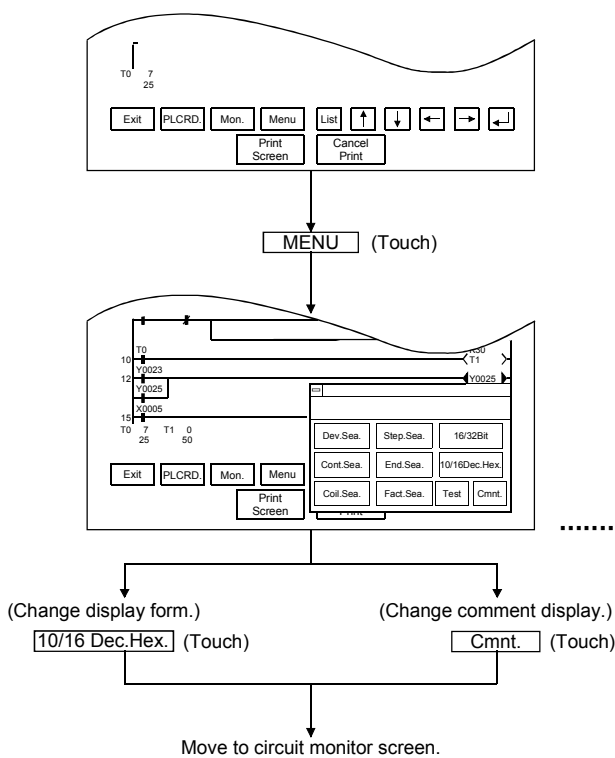

[Operation procedure]



* When there is a  at the upper left of the screen, touch it to return to the original screen.

When the screen below is currently displayed, it is not necessary to touch this.

Touch the appropriate display position on the ladder monitor menu.

..... After moving to the ladder monitor screen, the word device value is  when you touch .

(When changing to hexadecimal display)

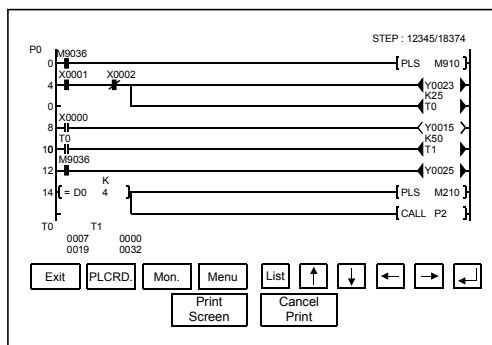

(When changing to comment display)

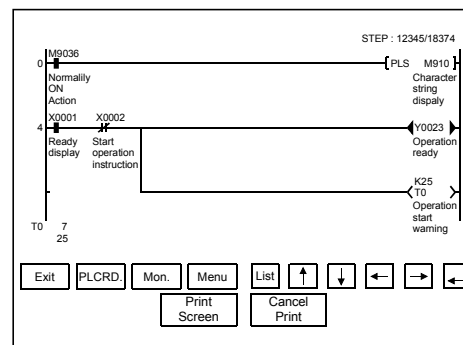

6.3.4 Changing the device value



CAUTION

- Read the manual carefully and fully understand the operation before the test operation (ON/OFF of bit devices, modifying current value of a word device, modifying timer/counter setting, modifying the current value, or modifying the current value of a buffer memory) of ladder monitor.
- In addition, never modify data in a test operation to a device, which performs a crucial operation to the system.
- It may cause an accident by a false output or malfunction.

Changing the device value on the screen during ladder monitoring is described. Switches for the timer/counter value display format (decimal/hexadecimal), and the comment display for the corresponding device (on/off) can be performed.

(1) Device value changing method

The device value changing method during ladder monitoring is described below:

<Circuit monitor Screen>

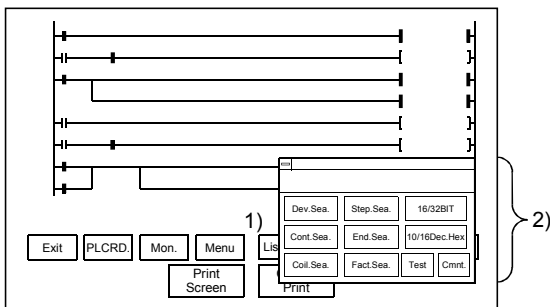

Display the ladder monitor screen by touching

LADDER MON.

- 1) Display the screen shown in 2) by touching **Menu**.
- 2) Display the test window by touching **Test**.

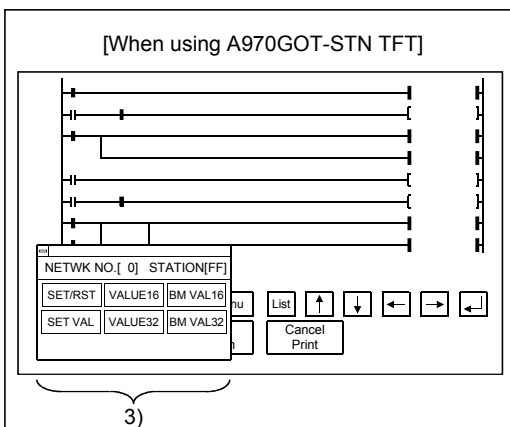

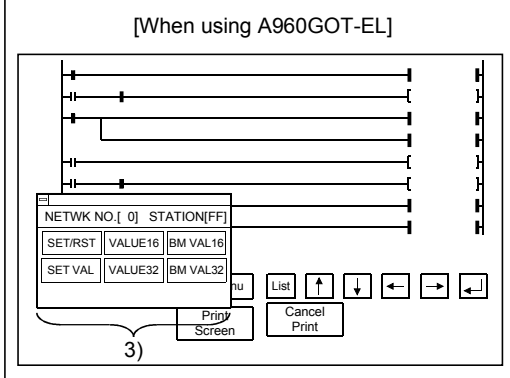

- 3) As the test window will open, perform the operation by seeing Sec. 9.6.

After the device change is complete, the changed contents can be verified in the ladder monitor.



NOTE

The current value display of the word device becomes hidden from view due to the test window.

Using the   key entries, the hidden current value display can be displayed by scrolling to the right/left.

6.3.5 About Hardcopy Output

This section describes the way to print the ladder monitor screen with the printer or to save it in the PC card in the BMP/JPEG file format during ladder monitor.

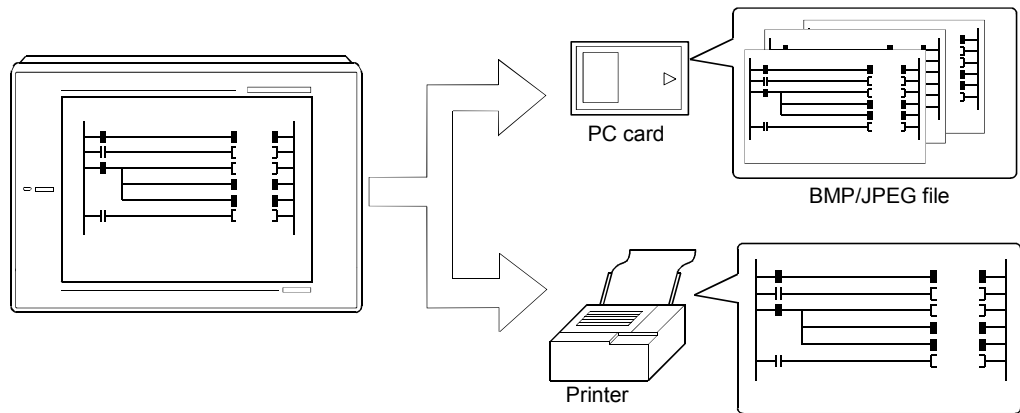

Depending on the used GOT, output the hardcopy in the following corresponding method.

(1) When A985GOT or A97*GOT is used

Touch the **Print Screen** or **Cancel Print** key displayed on the ladder monitor screen to output the hardcopy.

(2) When A95*GOT or A956WGOT is used

Set the start/stop triggering device of the hardcopy function on GT Designer and turn that device ON/OFF to output the hardcopy.

POINT

- When printing out the ladder monitor screen, always install the option driver into the GOT.
- Set the output destination (PC card/printer) of the hardcopy in the hardcopy setting of GT Designer.
Refer to Help of GT Designer for details of the hardcopy setting.

MEMO

CHAPTER7 ERROR DISPLAY AND HANDLING WITH LADDER MONITORING

The following chart shows the error messages that are displayed during the ladder monitor operation and the method of handling them.

Error Message	Description	Method of Handling
ENTRY CODE MISMATCH	The specified keyword is different from the keyword that is registered in the object PLC CPU.	Check the keyword that is registered in the object PLC CPU and specify again.
FILE NOT FOUND	(1) An attempt was made to switch to the ladder monitor screen when a sequence program had not been read. (2) When the file is selected and the Read key is pressed, the selected file does not exist in the PLC drive.	Read the sequence program that is written in the object PLC CPU. (Ex.) A sub-sequence program can only be specified as A3[] CPU/A4UCPU.
PLC COMMUNICATION ERROR	(1) Cannot communicate with PLC CPU of the specified network No. or station No. (2) The specified drive does not exist.	Check and correct the following: (1) Does the specified PLC CPU exist? (2) Is it online? (Data communication status?) (3) Has an error occurred?
LOCK ON OTHER MACHINE. PLEASE CANCEL	File is locked with the peripheral equipment (GX Developer, GPPQ).	After reading and writing with the peripheral equipment (GX Developer, GPPQ), read the file again.
NOT EXISTING DRIVE, DRIVE ERROR	(1) The specified drive does not exist. (2) The specified drive is faulty.	(1) Check whether the specified drive exists or not. (2) Check whether the specified drive is faulty or not.
ENTRY CODE MISMATCH	The specified file password differs from the one registered as the file password of the corresponding PLC CPU.	Confirm the file password registered to the drive of the corresponding PLC CPU, and specify it again.
FILE NOT FOUND	When you selected the file and pressed the Read key, the selected file did not exist in the PLC CPU drive.	(1) Perform read from the PLC on the network No./station number input screen, and update the file list. (2) Change the specified drive (corresponding memory).
USE BY OTHER MACHINE. PLEASE CANCEL	The sequence or comment is being used by the peripheral device (GX Developer).	Perform file read again after completion of read/write from/to the peripheral device (GX Developer).
2M bytes of comments were read since they exceeded 2M bytes.	Only 2M bytes of the comment file was read because its size is greater than 2M bytes.	—————
Outside CPU reset/device range/special module illegal access	The accessed special module is faulty or does not exist.	Check the system configuration.

MEMO

CHAPTER8 OPERATION PROCEDURES FOR THE SYSTEM MONITOR FUNCTION

The operation procedures for using the system monitor function are explained in this section.

8.1 Operation procedures before starting system monitoring

This section contains a summary of the procedure for transmitting the system program (OS) for the system monitor function from the Personal computer to the GOT until it is installed in the built-in memory.

For details, please refer to the Help in the GT Designer.

Details of the screen display and key operation are shown in the Help.

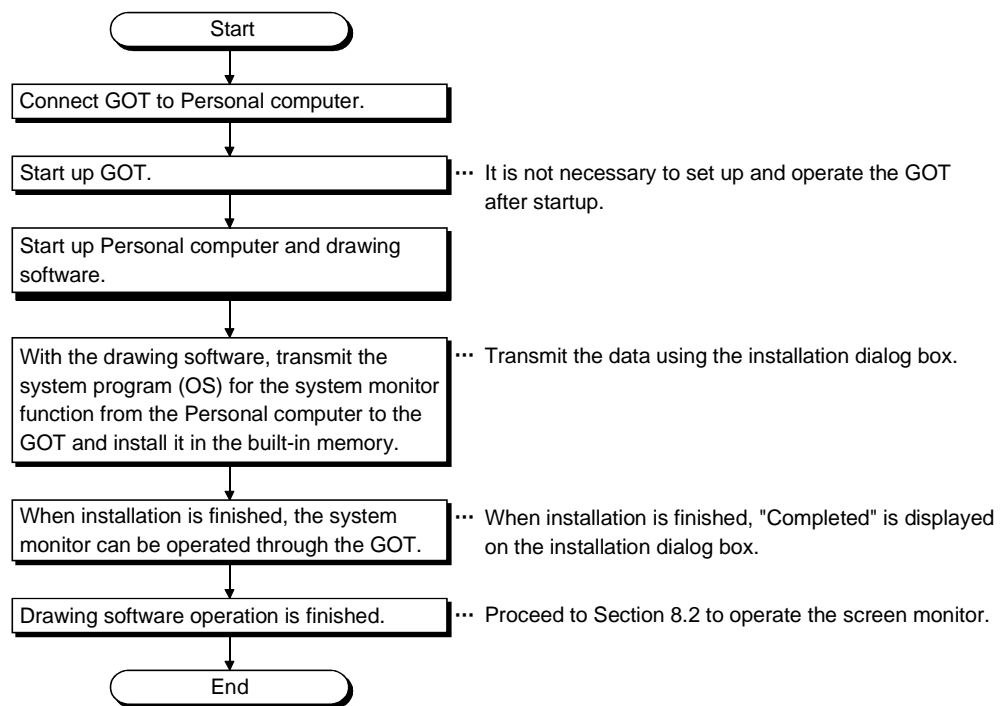

8 OPERATION PROCEDURES FOR THE SYSTEM MONITOR FUNCTION MELSEC-GOT

8.2 Operation procedures from user-created monitor screen display to start of system monitoring

This section explains the operation procedure for the GOT when starting each operation of the system monitor function, after the system program (OS) of the system monitor function has been installed in the GOT built-in memory.

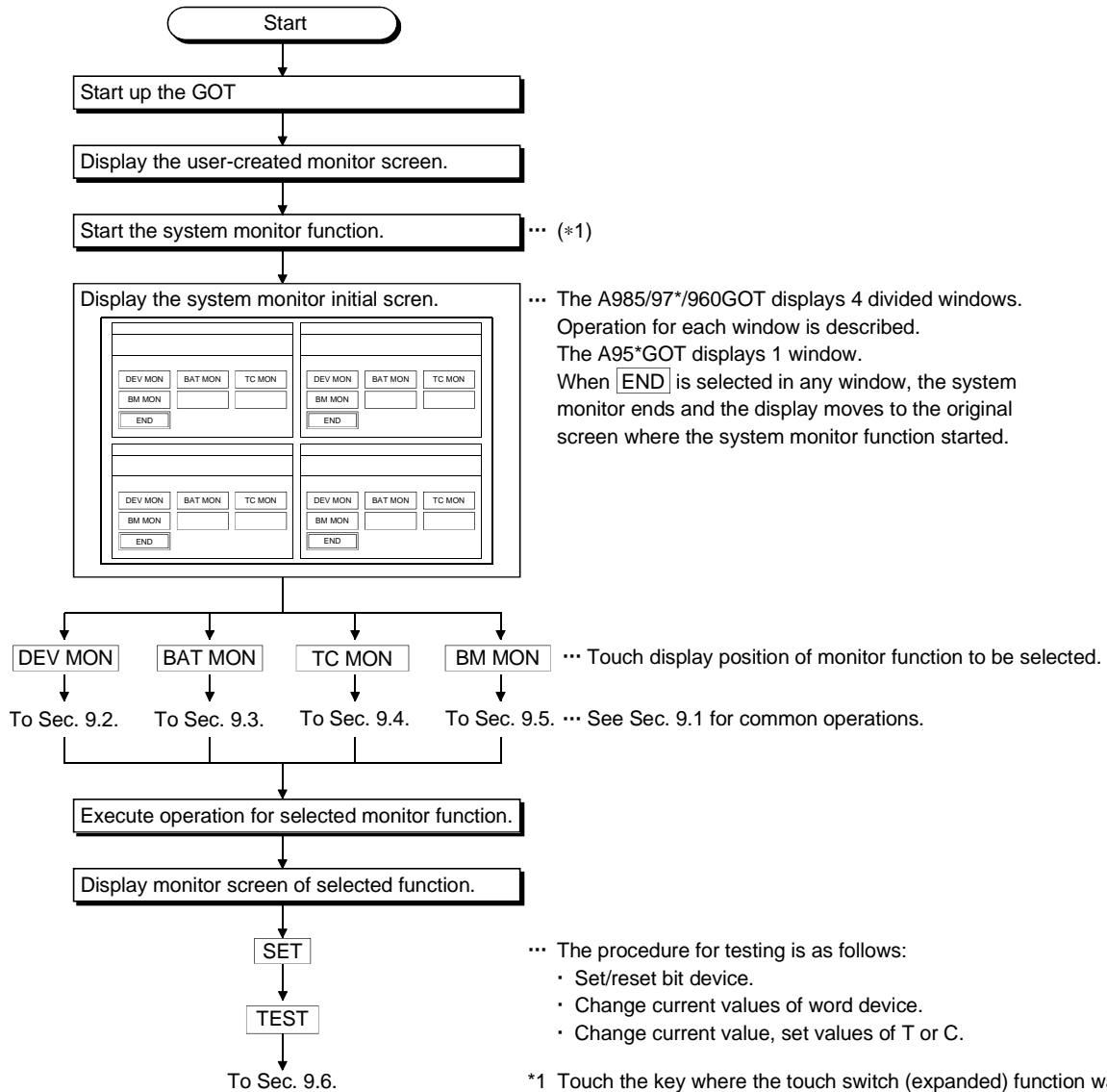

CHAPTER9 OPERATION OF THE VARIOUS SYSTEM MONITOR SCREENS

This chapter contains an explanation of each screen operation when using the system monitor function.

POINT	With any of the four windows, when changing the station/monitor device or executing the test operation, it is not possible to do an operation with another window until that series of operations is finished.
-------	--

9.1 Screen configuration, common operations and changing screens when monitoring

The common operations of each monitor function such as screen configuration and target PLC CPU specification when executing system monitoring are described below.

9.1.1 Basic screen configuration and key functions (menu)

The basic screen configuration displayed in the windows and the key functions displayed on the screen are shown below.

(1) Display

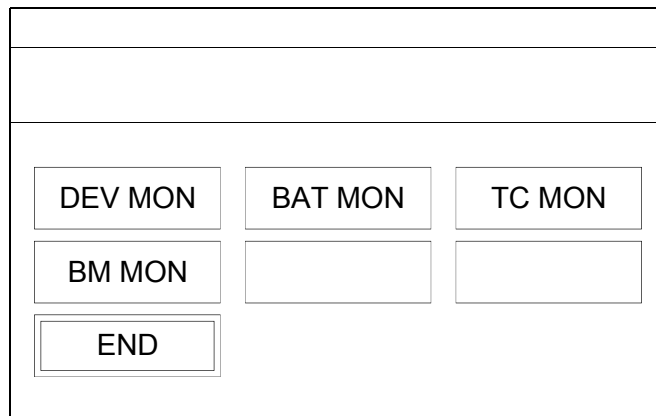

(2) Key functions

The functions of keys that are used with the basic screen operation are shown in the chart below.

Key	Function
DEV MON	The entry monitor is executed with the applicable window (see Sec. 9.2.).
BAD MON	The batch monitor is executed with the applicable window (see Sec. 9.3.).
TC MON	The timer/counter monitor is executed with the applicable window (see Sec. 9.4.).
BM MON	The buffer memory monitor is executed with the applicable window (see Sec. 9.5.).
END	System monitoring ends; display returns to the screen where system monitors function started.

9.1.2 Switching the display form (decimal/hexadecimal) and turning the comment display on/off (FORM)

(1) Switching the display form (decimal/hexadecimal)

Display the word device present value or the timer/counter present value or set value in decimal or hexadecimal.

(2) Switching the comment display on and off

Display the comment that is written in the object PLC CPU (Comment display priority order: expanded comment > Japanese character comment or Japanese kana comment).

(When changing to hexadecimal display)

DEVICE MONITOR	TEST	MENU	FORM	SET
NETWK No.[0]	STATION[FF]			
D 15	H	80000000		
D 10	H	8001		
X 001	●			
M 25	○			
Y 70	●			
W 200	H	002B		
R 50	H	04135		
C 200	H	7000		

(When changing to comment display)

DEVICE MONITOR	TEST	MENU	FORM	SET
NETWK No.[0]	STATION[FF]			
D 200	50			▲
	[Production line A]			
W 200	43			
	[Production quantity]			
R 50	68378428	DW		
	[link status]			
X 10	100			▼
	[Production line B]			

(3) Precautions for comment display

(a) When any of the following CPUs is being monitored, comments are not displayed.

- 1) FXCPU
- 2) Motion controller CPU (Q172CPU, Q173CPU)
- 3) QnACPU whose serial number indicated in the DATE field of the rating plate is earlier than 9707B

(b) When any of the following devices is being monitored, comments are not displayed.

- 1) Internal device (GB, GD, GS) of GOT
- 2) Host device (B, W, SB, SW) at the time of MELSECNET connection
- 3) Host device (X, Y, WW, WR) at the time of CC-Link connection

(c) When monitoring the QCPU (Q mode) or QnACPU, comments are not displayed if any of the following settings has been made in the PLC parameter setting (PLC file setting).

- 1) "Not used" has been selected for the comment file.
- 2) "Use the same file name as the program" has been selected for the comment file.
- 3) Password has been set to the comment file for the QCPU (Q mode).
- 4) Keyword has been registered to each memory for the QnACPU.
 - * Comments are displayed if the setting is changed using GX Developer or like.

(d) When the Q00J/Q00/Q01CPU is being monitored, comments are not displayed if the comment file "MAIN" does not exist in the program memory.

Below is an explanation of the operation for changing the display, using the Entry Monitor window as an example.

The operation procedure is the same for changing the display when selecting windows other than Entry Monitor.

[Operation procedure]

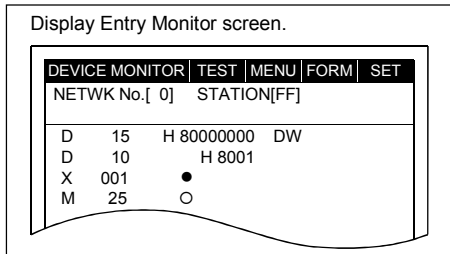

FORM (Touch)

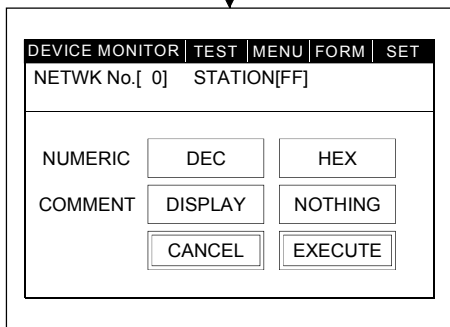

(Change display form.)

(Change comment display)

DEC HEX

YES NO

EXECUTE (Touch)

(Return)
Monitor screen

When you touch **MENU** you return to the basic screen.

When you touch **SET**, the monitor station and device) can be specified. (See Sec. 9.1.3)

When you touch **FORM**, you can change this display.

The selected **FORM** display is also found on the screen displayed after selecting the monitor function with the basic screen and on each menu screen, in addition to each monitor screen.

) Display monitor station network no. and station

* When you touch **CANCEL**, the display change is interrupted and the display returns to the monitor screen.

(1) Touch the display position of the selected menu.

POINT
<p>After starting the system monitor, if the PLC CPU comment or comment capacity is changed, the comment may not be correctly displayed on each monitor screen.</p> <p>When changing the comment or comment capacity, re-start the GOT.</p>



9.1.3 Specifying the monitor station and device (SET)

An explanation of the procedure for specifying the monitor station and the device for executing the system monitor is explained below, using the Entry Monitor window as example.

The operation procedure is the same for specifying the monitor station and device when selecting windows other than Entry Monitor.

* When there is a  (keywindow), touching it to returns to the monitor screen.

[Operation procedure]

Select monitor function with basic screen.
Or, display  monitor screen or  menu screen.

.....See Sec. 9.1.1.

.....See the explanatory section for each monitor screen and the menu screen.

DEVICE MONITOR		TEST	MENU	FORM	SET
NETWK No.[0]		STATION[FF]			
D	15	-2147483648	DW		
D	10	-32767			
X	001	●			
M	25	○			
T	30		100	200	○
W	200		43		
R	50	68378428	DW		
C	5	300	300	■ ●	

.....When you touch **MENU** you return to the basic screen.

When you touch **FORM**, you change this display. (See Sec. 9.1.2.)

When you touch **SET**, you can specify the monitor station and device.

SET (Touch)

DEVICE MONITOR		MENU	FORM	SET
NETWK No.[0]		STATION[FF]		
ENTRY	DELETE	ALL CLR		
TEST				
CANCEL				

ENTRY (Touch)

1)

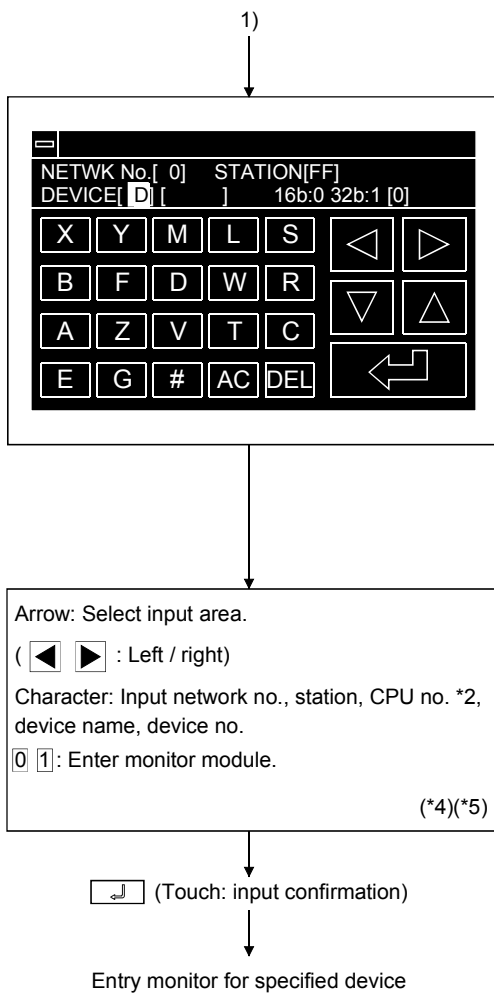

1) Specify network No., station No.*1 and CPU No.*2 of object PLC CPU.

(For data link system)

NET WK No.: 0
 STATION : FF (Host station)
 0 (Master station)
 1 to 64 (Local station)

(For network system)

NET WK No.: 0 (Host loop)
 1 to 255 (Specified loop)
 STATION : FF (Host station)
 0 (Control station)
 1 to 64 (Normal station)

(For Ethernet connection) *3

NET WK No. : 1 to 239
 STATION : 1 to 64

(For multi-CPU system)

CPU No. 0 to 4 (CPU number)

(2) Specify the device to be monitored.

(3) When specifying the word device or buffer memory as a monitor device, specify the monitor module.

0: 16-bit (1-word) module
 1: 32-bit (2-word) module

* Match the data to be entered; the touch key display at the bottom of the screen will change.

(EX.)

(When entering network no.)

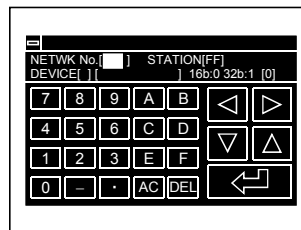

(When entering device no.)

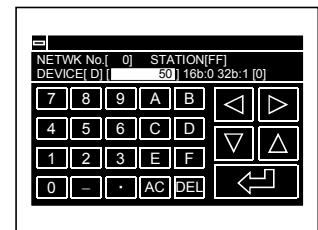

*1 For the station, with either system, specify "FF", which shows the PLC CPU to be accessed, or "0" to "64".

*2 Displayed for QCPU monitor only.

*3 The monitor target must be preset using GT Designer.
 For ACPU monitor, specify the network number/station number set on GT Designer.
 Refer to the help of GT Designer for details of the monitor target setting for Ethernet connection.

*4 Data being entered can be cleared by the following keys.

AC : Clears all data being entered to the target area.

DEL : Clears one character at the cursor position.

*5 The form of data to be entered is displayed at the right side of the screen.

DEC : Enter in decimal

HEX : Enter in hexadecimal

9.1.4 Changing screens

This section shows the screen changes when executing each monitoring operation of the system monitor function from the status where the user-created monitor screen is displayed.

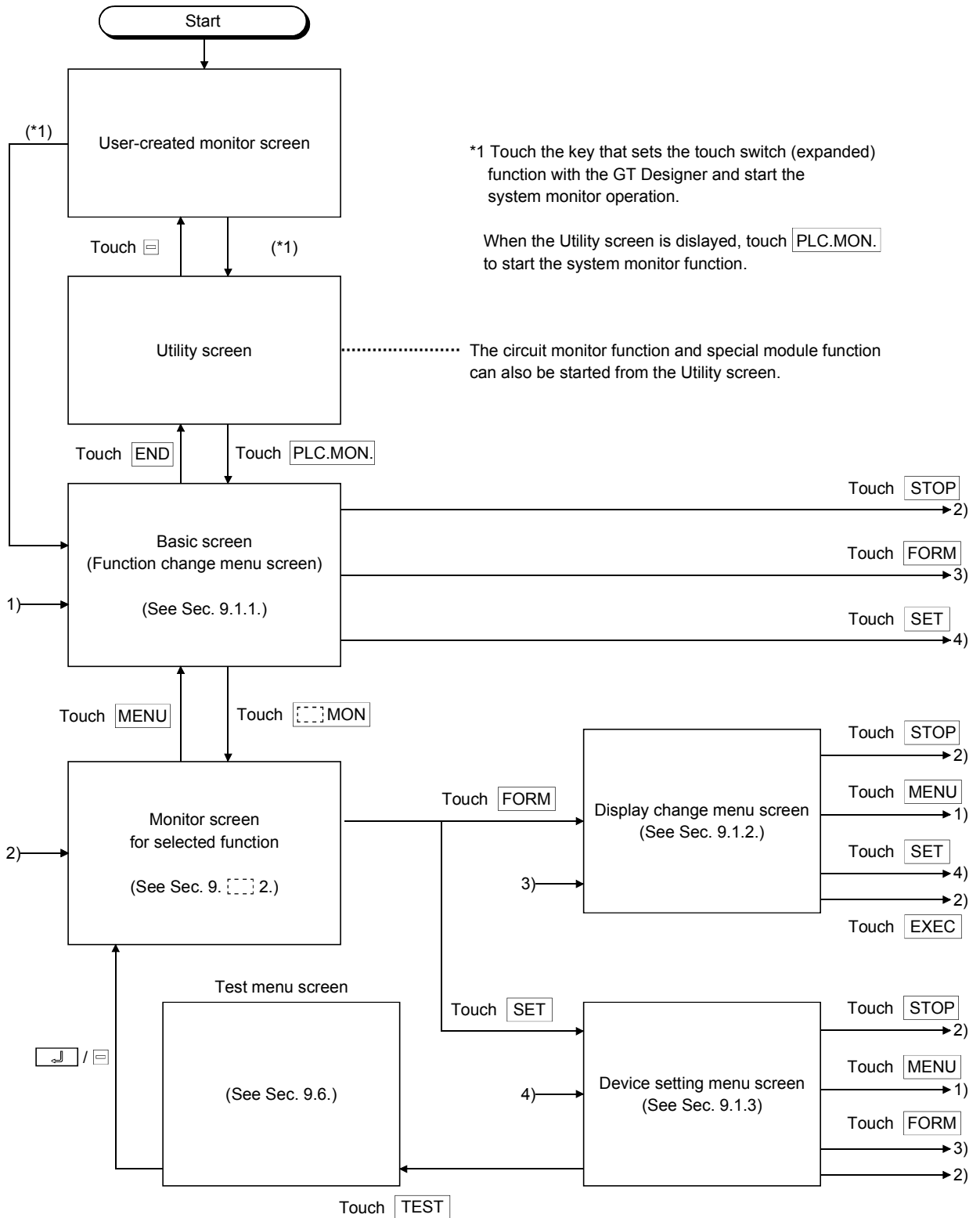

9.2 Entry monitor

Enter the device to be monitored in advance. The function that monitors only the device that was entered is called the "entry monitor".

The entry monitor operation when executing the system monitor function is explained below.

9.2.1 Basic operation

The entry monitor operation procedure is shown below.

See Sec. 9.1.1.

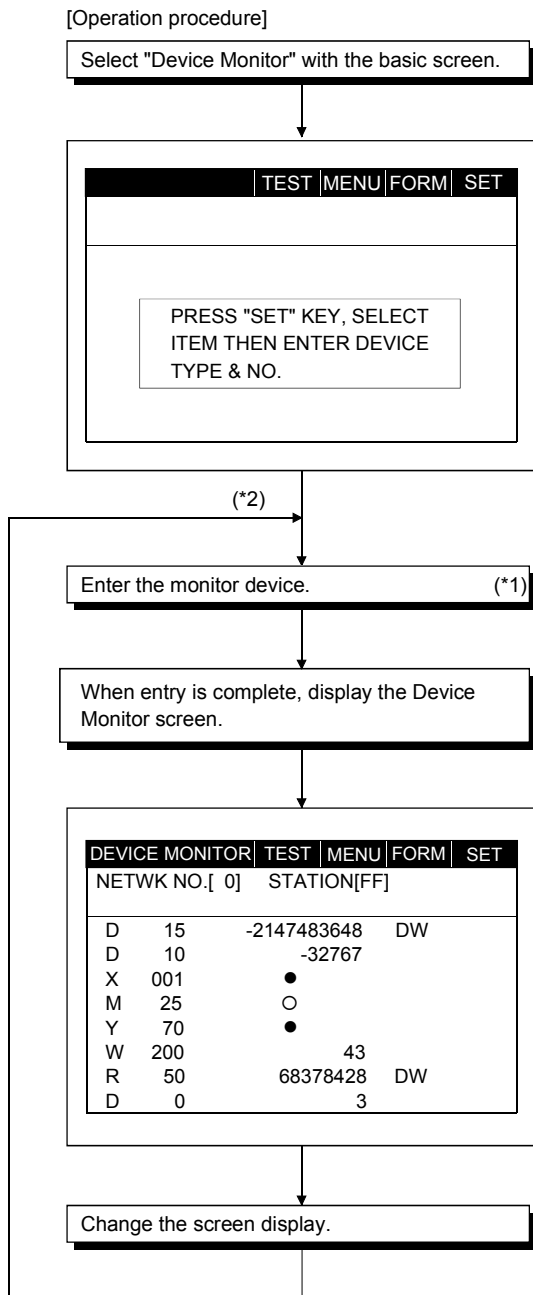

.....When a screen other than the basic screen is displayed, touch **MENU** at the top of the currently displayed screen, display the basic screen, and select Device Monitor.

.....When you touch **MENU**, you return to the basic screen. When you touch **FORM**, you can change this display (See Sec. 9.1.2.).

When you touch **SET**, you can specify the monitor station and device (See Sec. 9.1.3.).

.....Set the station and device to be monitored. For the setting method, see Sec. 9.1.3.

*1 Monitor device entry is in station modules.

If you change the station for the monitor device, all monitor devices entered before that are invalid.

*2 A maximum of 8 entry devices can be entered.

To enter more than 8, delete in order from the old entry device. The 8 most recent entry device will be monitored.

As needed, re-enter after deleting the entry device. (For the method of deletion, see Sec. 9.2.3.)

.....Do if needed.

For the display change method, see Sec. 9.1.2.

9.2.2 Entry monitor screen display and key functions

In this section, the Entry Monitor screen display and the functions of the keys displayed at the top of the screen are explained.

(1) Display

DEVICE MONITOR | TEST | MENU | FORM | SET

NETWK No.[0] STATION[FF]

D 200 30 ▲

[Line 1 current units]

W 200 43

[Production line A]

R 50 68378428 DW

[link status]

X 3 ●

[Input switch 3] ▼

1)

When comment is not displayed: max. 8 devices
 When comment is displayed : max. 4 devices
 Display when system monitoring
 Bit device..... ●: ON ○: OFF
 Word device.....Current value

1)	Displays the keys that are used with the operation of the Entry Monitor screen shown in (2) (Touch input).
2)	Displays the monitor station network No., station No. and CPU No.*1
3)	Displays the status and current value of the device.

*1 Displayed for QCPU monitor only.

(2) Key functions

The chart below shows the functions of the keys that are used with the Entry Monitor screen operation.



Key	Function
MENU	Move to basic screen (function change menu screen) to change to another monitor function or ending the system monitor (See Sec. 9.1.1.).
FORM	Move to the display change menu screen to change the numerical display on the Entry Monitor screen (decimal, hexadecimal) or changing the comment display (on/off) (See Sec. 9.1.2.).
SET	Move to device setting menu screen to enter the monitor device, delete the device, or execute a test. <ul style="list-style-type: none"> ● Entry of monitor device (See Sec. 9.1.3.) ● Deletion of entry device (See Sec. 9.2.3.) ● Test (See Sec. 9.6.)
▲ ▼	Scroll the display up or down one line, and display the monitor device that is not displayed (just before or after the current display). When five or more monitor devices are entered, operation is enabled when the monitor device comment is displayed. ▼ : Scrolls down one line. ▲ : Scrolls up one line.

9.2.3 Deleting a registered device

The operation of deleting (erasing) the entry of the device being monitored with the Entry Monitor screen is explained below.

The following two methods can be used to delete the registered device.

- Random deletionDeletes only one specified device.
- Batch deletionDeletes all devices that are currently registered.

* If there is a  at the upper left of the screen, touching the  returns to the monitor screen.

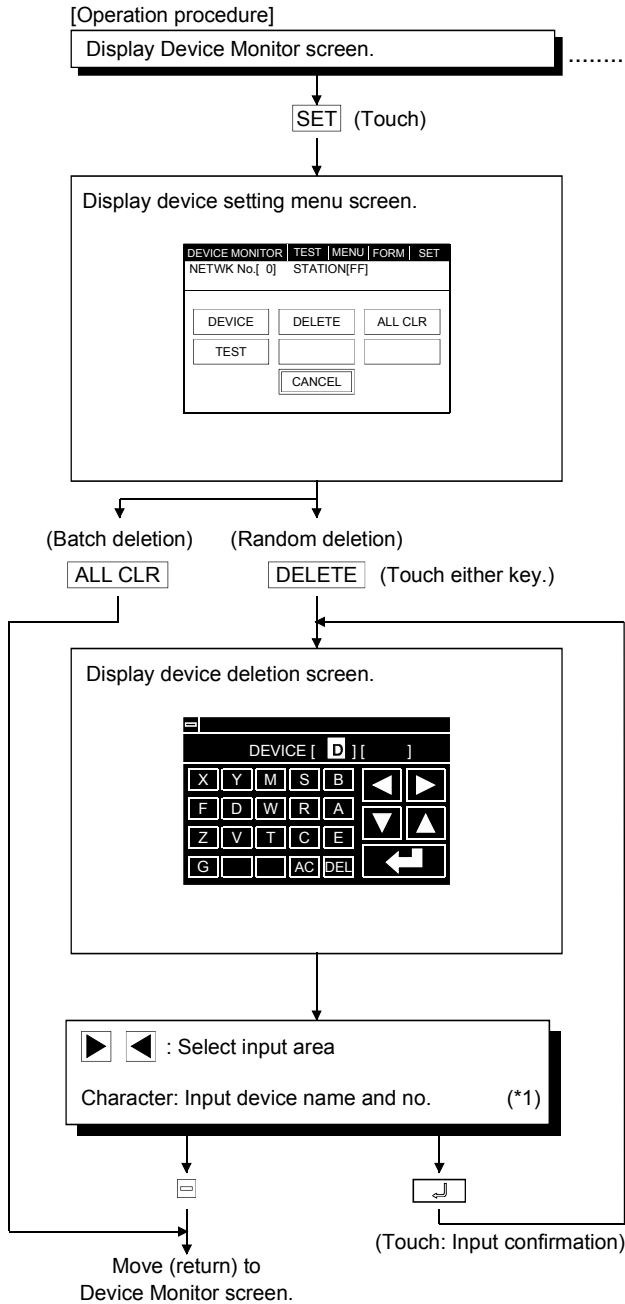

(1) Specify the device to be deleted.
 * Match the data to be entered; the touch key display at the bottom of the screen will change.

*1 Data being entered can be cleared by the following keys.

AC : Clears all data being entered to the object area.

DEL : Clears one character at the cursor position.

9.3 Batch monitor

When monitoring, the function of specifying the device at the beginning of an optional device range and monitoring it is called the "batch monitor".

The batch monitor operation when executing the system monitor is explained below.

9.3.1 Basic operation

The batch operation procedure is shown below.

See Sec. 9.1.1.

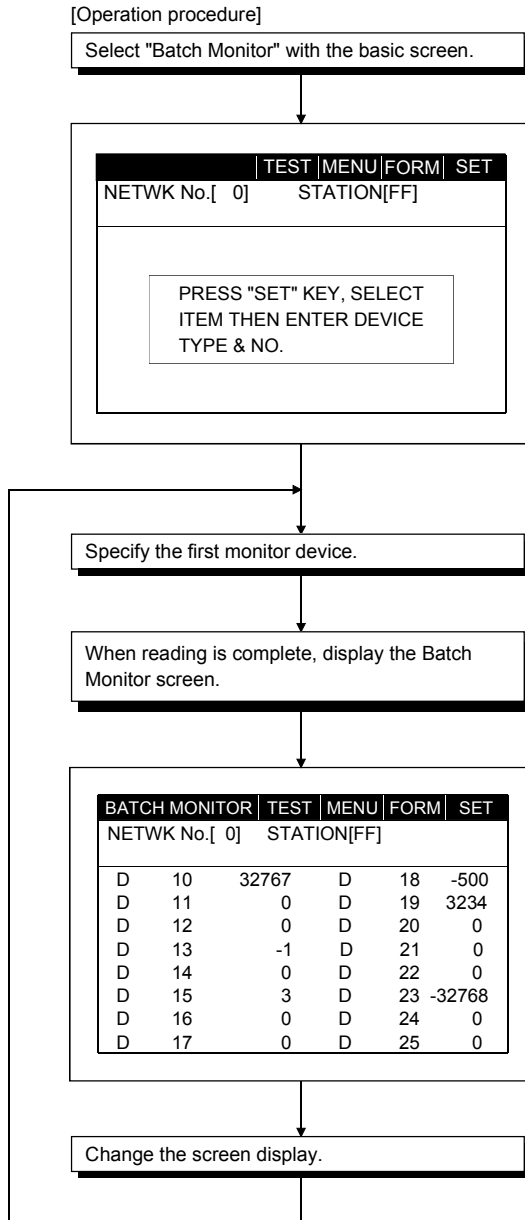

.....When a screen other than the basic screen is displayed, touch **MENU** at the top of the currently displayed screen, display the basic screen, and select "Batch monitor".

.....When you touch **MENU**, you return to the basic screen. When you touch **FORM**, you can change this display (See Sec. 9.1.2.).

When you touch **SET**, the monitor station and device can be specified (See Sec. 9.1.3.)

(1) Specify the station and device to be monitored. For the method of specifying, see Sec. 9.1.3.

.....Do if needed. For the display change method, see Sec. 9.1.2.

9.3.2 Batch monitor screen display and key functions

In this section, the Batch Monitor screen display and the functions of keys displayed at the top of the screen are explained.

(1) Display

2)

3)

BATCH MONITOR	TEST	MENU	FORM	SET
NETWK No.[0]		STATION[FF]		
D 10	32767[] ▲
D 11	0[Inventory quantity]
D 12	0[Shipment quantity]
D 13	-1[]
D 14	0[Warehouse A temperature]]
D 15	3[Warehouse B temperature]]
D 16	0[]
D 17	0[Production plan] ▼

1)

When comment is not displayed: max. 16 devices
 When comment is displayed : max. 8 devices
 Display when system monitoring
 Bit device.....● : ON ○ : OFF
 Word device.....Current value

1)	Displays the keys that are used with the operation of the Batch Monitor screen shown in (2) (Touch input).
2)	Displays the monitor station network No., station No. and CPU No.*1
3)	Displays the status and current value of the monitor device (The screen above shows when the monitor module is 16 bits.).

*1 Displayed for QCPU monitor only.

(2) Key functions

The chart below shows the functions of the keys that are used with the Batch Monitor screen operation.

Key	Function
MENU	Move to basic screen (function change menu screen) for changing to another monitor function or ending the system monitor (See Sec. 9.1.1.).
FORM	Move to display change menu screen for changing the numerical display on the Batch Monitor screen (decimal/hexadecimal) or changing the comment display (on/off) (See Sec. 9.1.2.).
SET	Move to device setting menu screen to change the monitor device or execute a test. <ul style="list-style-type: none"> • Change of monitor device (See Sec. 9.1.3.) • Test (See Sec. 9.6.)
▲ ▼	Scroll the display up or down one line, and display the monitor device that is not displayed (just before or after the current display). ▼ : Scrolls down one line. ▲ : Scrolls up one line.

9.4 TC Monitor (monitor of timer and counter)

The function that monitors only the time (T) and counter (c) when monitoring is called the TC monitor.

The TC monitor operation when executing the system monitor is explained below.

9.4.1 Basic operation

The TC operation procedure is shown below.

See Sec. 9.1.1.

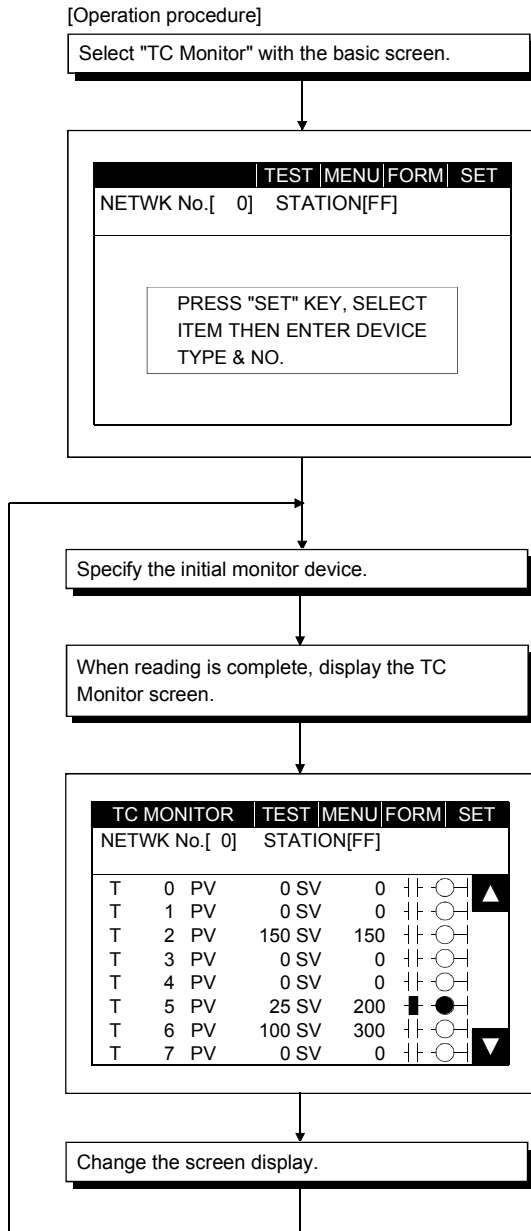

.....When a screen other than the basic screen is displayed, touch **MENU** at the top of the currently displayed screen, display the basic screen, and select "TC Monitor".

.....When you touch **MENU**, you return to the basic screen. When you touch **FORM**, you can change this display (See Sec. 9.1.2.).

When you touch **SET**, the monitor station and device can be specified (See Sec. 9.1.3.).

(1) Specify the station and device to be monitored. For the method of the specifying, see Sec.9.1.3.

.....Do if needed. For the display change method, see Sec. 9.1.2.

9.4.2 TC Monitor screen display and key functions

In this section, the TC Monitor screen display contents and the function of keys displayed at the top of the screen are explained.

(1) Display

2)

3)

	TC MONITOR	TEST	MENU	FORM	SET		
	NETWK No.[0]	STATION[33]					
	FILE [ABCDEF.PRG]						
	T 0 PV 0	SV 0	⇄	○	▲		
	[Production line A]						
	T 1 PV 0	SV 0	⇄	○			
	[Production line B]						
	T 2 PV 150	SV 150	■	●			
	[Production line C]						
	T 3 PV 0	SV 0	⇄	○	▼		
	[Production line D]						

1)

When comment is not displayed: max. 8 devices
 When comment is displayed : max. 4 devices
 Display when system monitoring
 T/Ccurrent value, set value
 (Contact point, coil) ■ ● : ON
 ⇄ ○ : OFF

1)	Displays the keys that are used with the operation of the TC Monitor screen shown in (2) (Touch input).
2)	Displays the monitor station network No., station No. and CPU No.*1 When connected to QCPU and QnACPU, the execution file name is displayed (If there are more than one file, the first file name is displayed.).
3)	Displays the current value, set value, contact point and coil status of the monitor device (The screen above shows when the monitor module is 16 bits.).

*1 Displayed for QCPU monitor only.

(2) Key functions

The chart below shows the function of the keys that are used with the operation of the TC Monitor screen.

Key	Function
MENU	Move to basic screen (function change menu screen) for changing to another monitor function or ending the system monitor (See Sec. 9.1.1.).
FORM	Move to display change menu screen for changing the numerical display on the TC monitor screen (decimal/hexadecimal) or changing the comment display (on/off) (See Sec. 9.1.2.).
SET	Move to device setting menu screen to change the monitor device or execute a test. <ul style="list-style-type: none"> • Change of monitor device (See Sec. 9.1.3) • Test (See Sec. 9.6.)
▲ ▼	Scroll the display contents up or down one line to display the monitor device that is not displayed (just before or after the current display). Operation is enabled when monitor device comment is displayed. <ul style="list-style-type: none"> ▼ : Scrolls down one line. ▲ : Scrolls up one line.

9.5 BM Monitor (monitor of buffer memory)

When monitoring, the function that monitors the buffer memory of the special function module is called the "BM monitor".

The BM monitor screen when executing the system monitor is explained below.

9.5.1 Basic operation

The BM Monitor operation procedure is shown below.

See Sec. 9.1.1.

[Operation procedure]

Select "BM Monitor" with the basic screen.

.....When a screen other than the basic screen is displayed, touch **MENU** at the top of the currently displayed screen, display the basic screen, and select "BM Monitor".

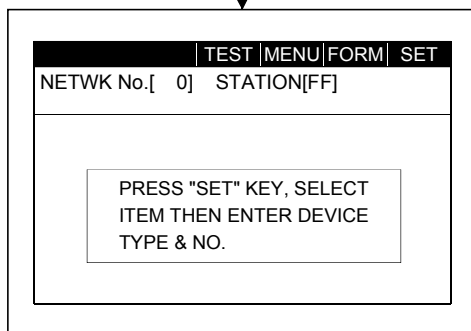

.....When you touch **MENU**, you return to the basic screen. When you touch **FORM**, you can change this display (See Sec. 9.1.2.).

When you touch **SET**, the monitor station and device can be specified (See Sec. 9.1.3.).

Specify the initial monitor device.

(1) Specify the station and device to be monitored, and the monitor module (16-/32-bit module).

When reading is complete, display the BM Monitor screen.

(2) For the method of the specifying, see Sec.9.1.3. Specify the module to be monitored and the buffer memory as follows.

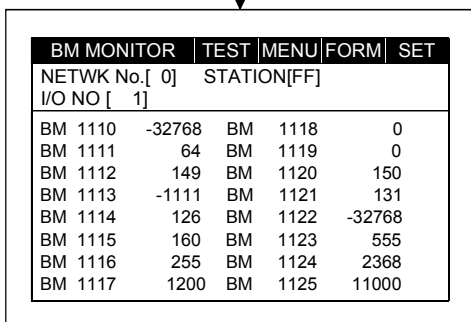

Initial Y [] []

Specify the initial address of the buffer memory in decimal.

When the initial I/O signal of module is displayed with three digits, specify the first two digits.

Change the screen display.

.....Switching between decimal and hexadecimal display is enabled. Do this as needed. For the display change method, see Sec. 9.1.2.

9.5.2 BM Monitor screen display and key functions

In this section, the BM Monitor screen display and the functions of keys displayed at the top of the screen are explained.

(1) Display

	BM MONITOR	TEST	MENU	FORM	SET
2)	NETWK No.[0] STATION[FF]		I/O NO[1]		
3)	BM 1110	-32767	BM 1118	0	
	BM 1111	64	BM 1119	0	
	BM 1112	149	BM 1120	150	
	BM 1113	-1111	BM 1121	131	
	BM 1114	126	BM 1122	-32768	
	BM 1115	160	BM 1123	555	
	BM 1116	255	BM 1124	2368	
	BM 1117	1200	BM 1125	11000	

1)

Displays current value of a maximum of 16 devices.

1)	Displays the keys that are used with the operation of the BM Monitor screen shown in (2) (Touch input).
2)	Displays the monitor station network No., station No., CPU No.*1 and the first 2 digits of the I/O signal No. of the object module.
3)	Displays the current values of the buffer memory (The screen above shows when the monitor module is 16 bits.).

*1 Displayed for QCPU monitor only.

(2) Key functions

The chart below shows the function of the keys that are used with the operation of the BM Monitor screen.

Key	Function
MENU	This moves to basic screen (function change menu screen) for changing to another monitor function or ending the system monitor (See Sec. 9.1.1.).
FORM	This moves to display change menu screen for changing the number display on the BM monitor screen (decimal/hexadecimal) (See Sec. 9.1.2.).
SET	This moves to device setting menu screen to change the monitor device or execute a test. <ul style="list-style-type: none"> • Change of monitor device (See Sec. 9.1.3.) • Test (See Sec. 9.6.)

9.6 Test

CAUTION

- Read the manual carefully and fully understand the operation before the test operation (ON/OFF of bit devices, modifying current value of a word device, modifying timer/counter setting, modifying the current value, or modifying the current value of a buffer memory) of system monitor.
- In addition, never modify data in a test operation to a device which performs a crucial operation to the system. It may cause an accident by a false output or malfunction.

When monitoring with the system monitor function, you can specify an optional station or device to be monitored and test it.

The operation of testing a bit device, word device, or special module buffer memory of the PLC CPU is explained in this section.

9.6.1 Basic operation

The operation procedure for testing when monitoring with the system monitor function is shown below.

See Sec. 9.2.

[Operation procedure]

When monitoring with the system monitor function, display any monitor screen.

DEVICE MONITOR				TEST	MENU	FORM	SET
NETWK No.[0]		STATION[FF]					
D	15	-2147483648	DW				
D	10	-32767					
X	001	●					
	25	○					

SET (Touch)

Display device setting menu screen.

DEVICE MONITOR				TEST	MENU	FORM	SET
NETWK No.[0]		STATION[FF]					
DEVICE		DELETE		ALL CLR			
TEST							
				CANCEL			

TEST (Touch)

Display test menu screen.

DEVICE MONITOR				MENU	FORM	SET
NETWK No.[0]		STATION[FF]				
SET/RST		VALUE16		BM VAL16		
SET VAL		VALUE32		BM VAL32		
				CANCEL		

1)

.....When a screen other than the monitor screen is displayed, display any monitor screen according to the explanatory section for each monitor function.

.....When Device Monitor screen is displayed.

.....When you touch CANCEL, the display moves (returns) to the previous monitor screen.

.....When you touch CANCEL, the display moves (returns) to the previous monitor screen.

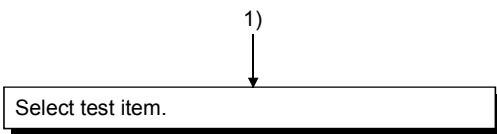

When **SET/RST** is selected.

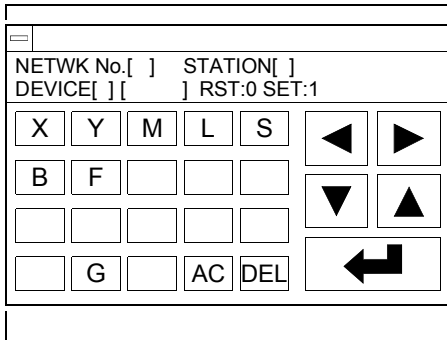

When **VALUE16** / **VALUE32** is selected.

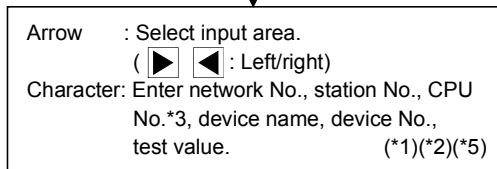
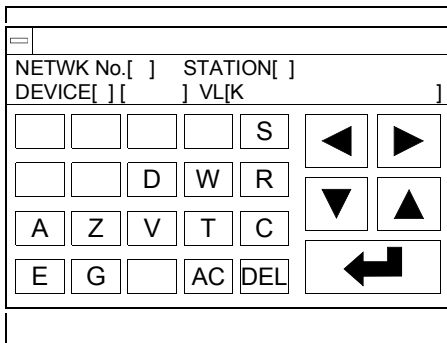

(Touch: input confirmation)

Move (return) to screen where **SET** was specified.

(1) Touch either, depending on test contents.

SET/RST

SET/RST (set/reset) bit device.

VALUE16 or **VALUE32**

Change current value of word device.

SET VALUE

Change T, or C set value.

BM VAL16 or **BM VAL32**

Change current value of buffer memory.

* With **VALUE16** or **BM VAL16**, 16 bits is the object module.

With **VALUE32** or **BM VAL32**, 32 bits is the object module.

When **SET VALUE** is selected.

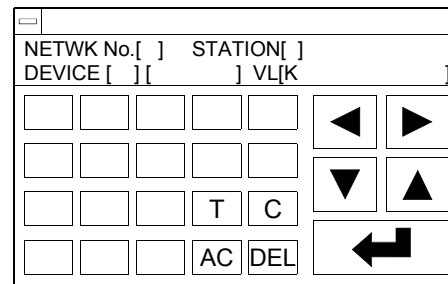

(2) Specify the network No., station No. and CPU No. of the object PLC CPU (See Sec. 9.1.3, *1.).

(For data link system)

Network No.: 0
 Station : FF (Own station)
 0 (Master station)
 1 to 64 (Local station)

(For network system)

Network No.: 0 (Host loop)
 1 to 255 (Specify loop)
 Station : FF (Own station)
 0 (Control station)
 1 to 64 (Normal station)

(For Ethernet connection)

Network No.: 1 to 239
 Station : 1 to 64

(For multi-CPU system) *

CPU No. 0 to 4 (CPU number)

* Displayed for QCPU monitor only.

(3) Specify object device.

(4) Specify test value.

· With **SET/RST** (set/reset) of bit device, specify 0 (RST) or 1 (SET).

· When changing current value of word device
 When changing T or C set value

or

When changing current value of buffer memory

Match current display form (decimal/hexadecimal) and specify change value. (*4)

*1 The data being entered can be cleared by using the following keys.

AC : Clear all data being entered in the object area.

DEL : Clear one character from the cursor position.

*2 The format for the data being entered is displayed on the right side of the screen.

DEC : Enter in decimal.

HEX : Enter in hexadecimal.

*3 The monitor target must be preset using GT Designer.

For ACPU monitor, specify the network number/station number set on GT Designer.

Refer to the help of GT Designer for details of the monitor target setting for Ethernet connection.

*4 Even when the setting value/current value is changed after the timer (T) has timed out and the counter (C) has finished counting, the time-up status/count-up status do not change. The current status is maintained.

(When the setting value is changed to a large value/when the current value is changed to a small value)

*5 When an index-qualified T/C set value is changed, only its constant part is changed. Its index-qualified part is not changed.

Example) Changing the set value of T5 from "300" to "200"

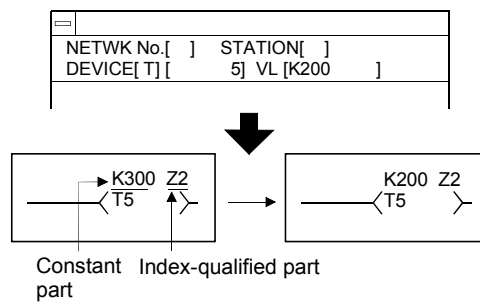

9.6.2 Quick test function

In addition to the existing tests for the direct input of device, station No., etc. during monitoring with the system monitor function, this function enables the bit device SET/RESET, word device, buffer memory data to change by a single touch.

1) Operation to set the quick test function on

To perform the quick test functions, perform the following operations:

[Operation procedure]

Display one of the system monitor screen.

DEVICE MONITOR	TEST	MENU	FORM	SET
NETWK No.[0]		STATION[FF]		
D	15	-2147483648	DW	
ZR	1042431	-32767		
X	0001	●		
M	25	○		
W	200	43		
R	50	68378428	DW	
D	0	0		
W	100	0		

.....When displaying the device monitor screen.

TEST (Touch)

DEVICE MONITOR	TEST	MENU	FORM	SET
NETWK No.[0]		STATION[FF]		
D		QUICK TEST MODE SET		
ZR	1042431			
X				
M				
W				
R				
D				
W	100	0		

.....The quick test is turned on by clicking on **OK**.

OK

DEVICE MONITOR	TEST	MENU	FORM	SET
NETWK No.[0]		STATION[FF]		
QUICK TEST				
D	15	-2147483648	DW	
ZR	1042431	-32767		
X	0001	●		
M	25	○		
W	200	43		
R	50	68378428	DW	
D	0	0		
W	100	0		

.....Status when the quick test function is on.

2) Operation to turn off the quick test function

When **TEST** is touched when the quick test function is on, a dialog box is displayed. When **OK** is touched, the quick test can be canceled.

3) Bit device quick test

DEVICE MONITOR	TEST	MENU	FORM	SET
NETWK No.[0]		STATION[FF]		
QUICK TEST				
D	15	-2147483648	DW	
ZR	1042431	-32767		
X	0001	●		
M	25	○		
W	200		43	
R	50	68378428	DW	
D	0		0	
W	100		0	

.....When the device monitor screen is displayed.

Touch the device name or device no. display position for the bit device to be SET/RESET.

DEVICE MONITOR	TEST	MENU	FORM	SET
NETWK No.[0]		STATION[FF]		
QUICK TEST				
D	15	-2147483648	DW	
ZR	1042431	-32767		
X	0001	●		
M	25	○		
W	200		43	
R	50	68378428	DW	
D	0		0	
W	100		0	

.....The device name and device no. touched is displayed highlighted.

When the on/off display (○, ●) of the highlighted display is touched, the status is SET/RESET.

* When the current bit device is ON, then it is turned OFF (RESET).

When OFF, it will be (SET).

DEVICE MONITOR	TEST	MENU	FORM	SET
NETWK No.[0]		STATION[FF]		
QUICK TEST				
D	15	-2147483648	DW	
ZR	1042431	-32767		
X	0001	○		
M	25	○		
W	200		43	
R	50	68378428	DW	
D	0		0	
W	100		0	

.....The on/off display area (○, ●) of the X0001 device is highlighted.

4) Quick test for the word device, T/C monitor, and buffer memory

.....When displaying the device monitor screen.

Touch the display position of the device to be changed.

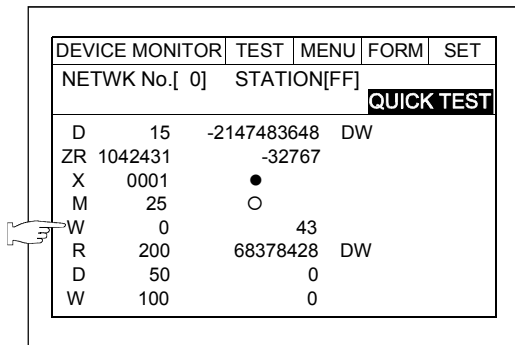

.....The change value input screen is displayed.

Enter the current value to be changed in the KEY window.

See Section 8.1.3 for the KEY window operations.

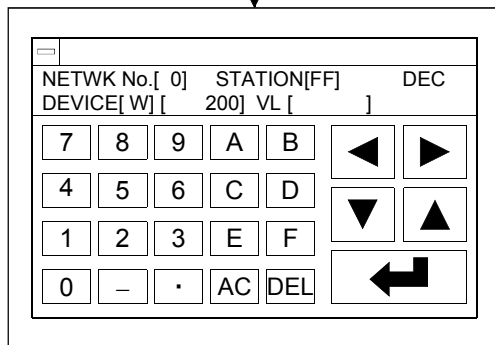

CHAPTER10 ERROR DISPLAY AND HANDLING WITH SYSTEM MONITORING

The following chart shows the error messages that may be displayed when operating the system monitor and the method of handling them.

Error Message	Description	Method of Handling
PLC communications error	Communication could not be established with the PLC CPU.	Check the following: <ul style="list-style-type: none">• Connections between the PLC CPU and the GOT (disconnected or cut cables).• Has an error occurred in the PLC CPU?

CHAPTER11 OPERATION PROCEDURES FOR SPECIAL MODULE MONITOR FUNCTION

The operation procedure when using the special module monitor function is explained in this chapter.

11.1 Operation procedures before starting special module monitoring

This section contains a summary of the procedure for transmitting the system program (OS) for the special module monitor function and the special module monitor data from the personal computer to the GOT until it is installed in built-in memory. For details, please refer to the Help in GT Designer. Details of the screen display and key operation are shown in the Help.

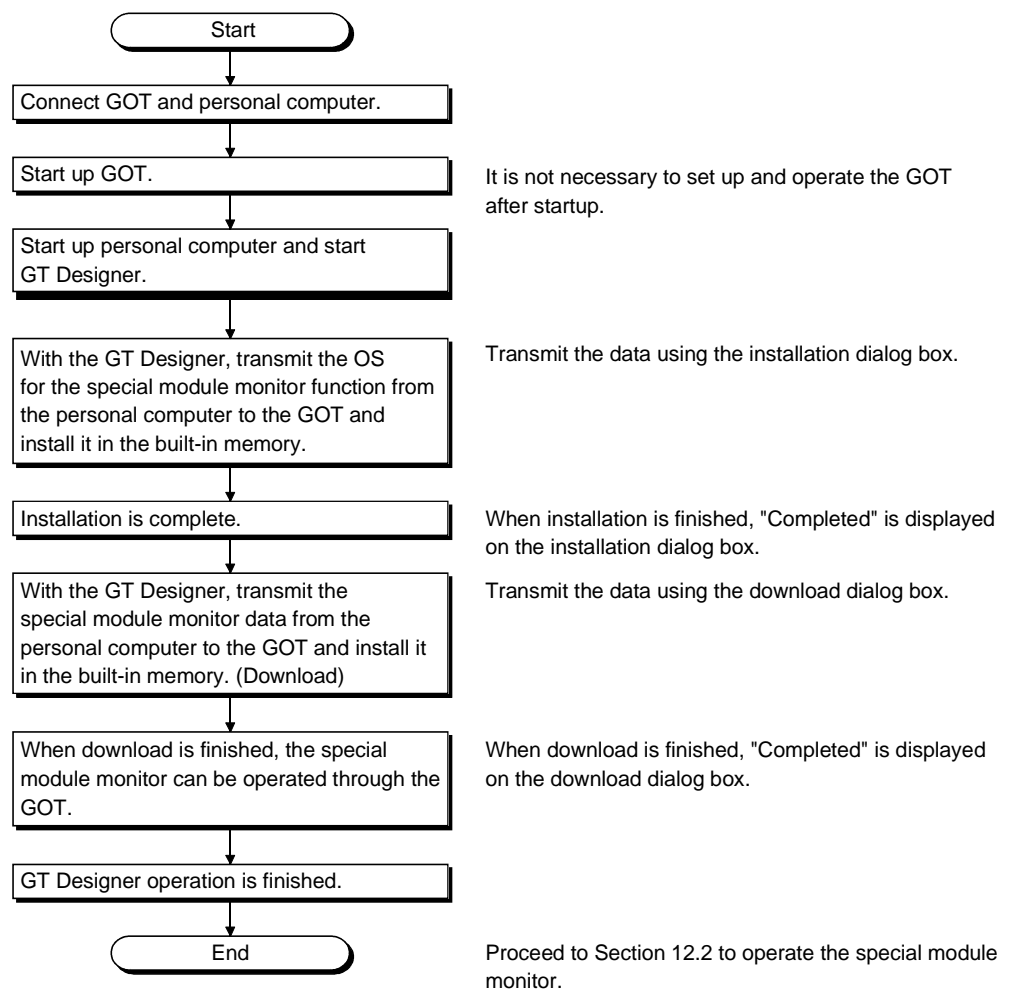

11.2 Operation procedures from user-created monitor screen display to start of special module monitor

This section describes the operation procedure for the GOT when starting each operation of the special module monitor function after the system program (OS) of the special module monitor function has been installed in the GOT built-in memory, and downloading the special module monitor data.

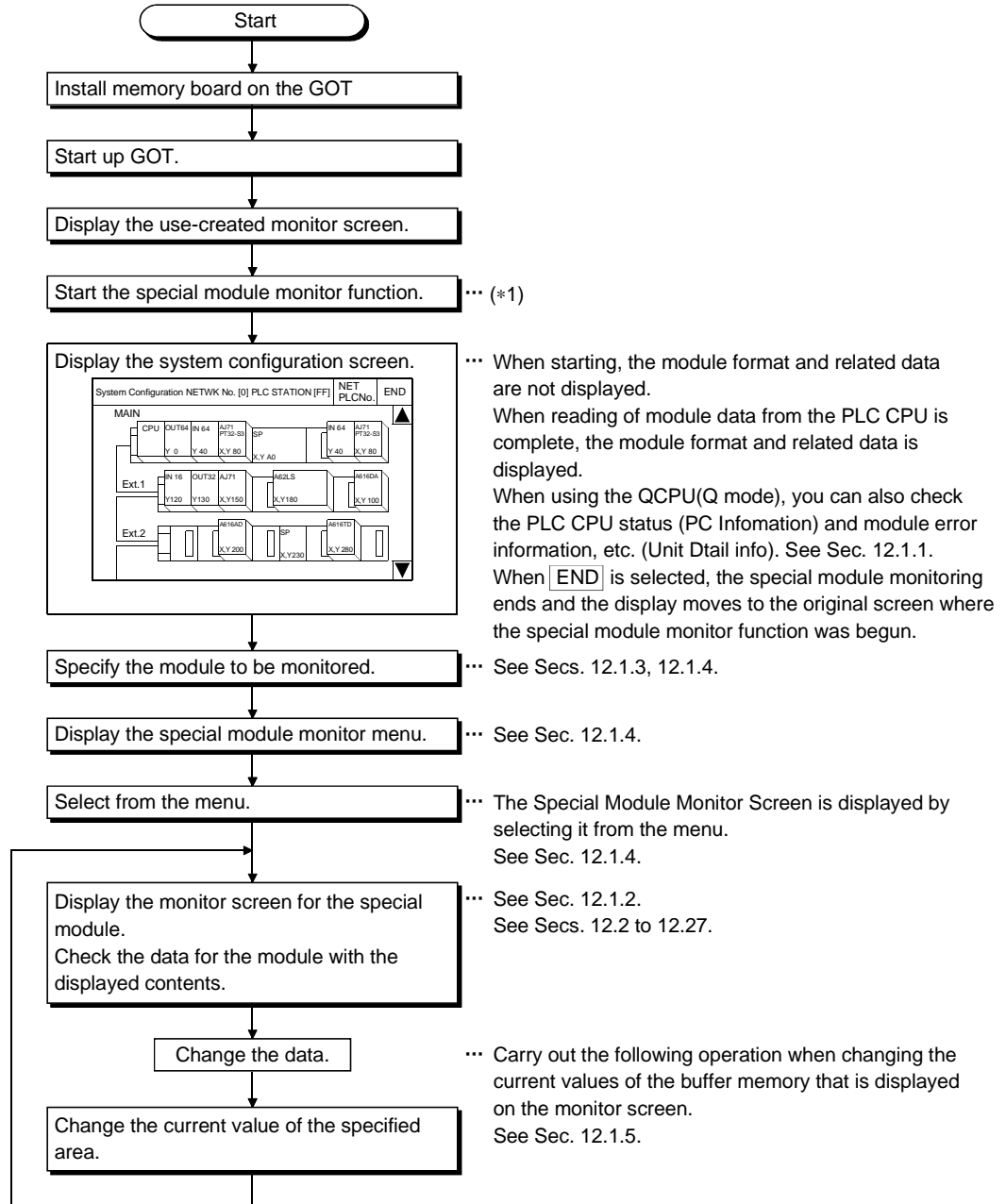

*1 Touch the key where the touch switch (expanded) function was set with the drawing software, and start the system monitor function. When the Utility screen is displayed, touch [SP.Mon.] to start the special module monitor function.

CHAPTER12 OPERATION OF EACH SPECIAL MODULE MONITOR SCREEN

Each screen operation when using the special module monitor function is explained in this chapter.

12.1 Screen configuration, common operation and changing screens when monitoring

The screen configuration and common operations used when executing the special module monitor are explained in this section.

12.1.1 Composition of system configuration screen and key functions

This section describes the structure of the system configuration screen that is displayed after starting the special module monitor function and the key functions displayed on the screen.

(1) When using the QCPU(A mode), QnACPU or ACPUCPU

(a) Display

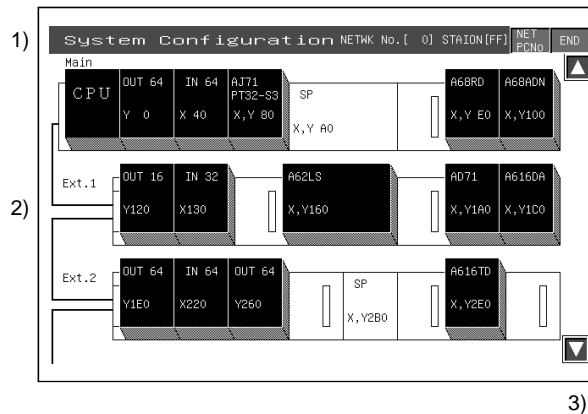

The module format and related data are displayed at the end of the module data readout from the PLC CPU. (OS executes it automatically.)
When connected to MELSECNET, the screen shown in Section 12.1.3 is displayed.

1)	Displays network No. and station No.. of monitor station.
2)	With the module installed in the monitor station, the special function module displays the format and the initial no. of the I/O signal with the sequencer CPU; the I/O module displays "Input"/"Output" and the I/O points. For a special function module that cannot be monitored, "Special" and the initial no. of the I/O signal are displayed. The display position of the module is the key for moving the special function module monitor of that module to the screen where it is executed (Touch input)
3)	The keys used for the operation with the System Configuration screen shown in (b) are displayed. (Touch input)

(b) Key functions

The chart below shows the functions of the keys that are used with the System Configuration screen operation.

Key	Function
END	Monitoring ends; and display returns to the screen where the special module monitor function was begun.
Module display position	Moves to screen where the special module monitor for that module is executed. Slots 0 through 7 are valid for each base module.
▲ ▼	Scrolls display up or down one level to display the system configuration of the level number just before or after the one that is currently displayed. Operation of these keys is enabled when the system configuration extends to three levels or more. ▼: Scrolls down one level. ▲: Scrolls up one level.

(2) When using the QCPU(Q mode)

(a) Display

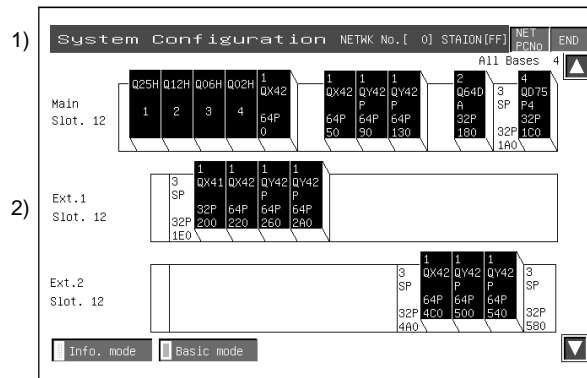

The module format and related data are displayed on completion of module data read from the PLC CPU.
(OS executes it automatically.)

1)	Displays the network number and station number of the monitor station. For the modules installed in the monitor station, their formats, I/O points and first I/O numbers are displayed. For special function modules which cannot be monitored, their formats are displayed as "Special".
2)	The module display position acts as the key to shift to the screen where the module will be monitored. (Touch input) In case of a multi-CPU system, the CPU No. is displayed for the CPU and the control CPU No. is displayed for the installed module.
3)	The keys used for the operation on the System Configuration screen shown in (b) are displayed. (Touch input)

(b) Key functions

The following table indicates the functions of the keys used to perform operation on the System Configuration screen.

Key	Function
END	Monitoring ends, and the display returns to the screen where the special module monitor function was started.
QCPU	Shifts to the PC Information screen. (Refer to Section 12.1.3)
Module display position	Basic mode: Shifts to the screen where that special module will be monitored. Info. mode: Shifts to the screen which shows the detail information of the selected module.
Basic mode	Switches the System Configuration screen to the info. mode. (Refer to Section 12.1.4)
Info. mode	Switches the System Configuration screen to the Basic mode.
▲ ▼	Scrolls the display one base up or down to display the system configuration of the currently undisplayed base immediately before/after the currently displayed base. This operation cannot be performed when the system has three or more extension bases. ▼: Scrolls one base down. ▲: Scrolls one base up.

12.1.2 Setting method for remote station monitoring

The setting method to perform remote station monitoring during special module monitoring is described below.

<Special Module Monitor>

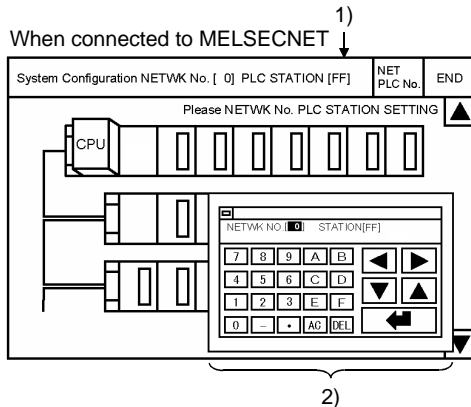

Touch **SP.UNIT** to display the system configuration screen. Depending on the connection method, the screen first displayed will be different as indicated below.

Bus connection and CPU direct connection	The base of the connection station is displayed.
Ethernet connection	The base of the station set as the host is displayed.
CC-Link (via G4) connection	The base of the master station is displayed.
MELSECNET (II), /B connection	No system configuration display
MELSECNET/10 connection CC-Link connection (Intelligent device station)	No system configuration display

for MELSECNET/CC-Link connections, the following operations will always be required:

- 1) Touch **NETPCNo.** to display the window shown in 2)
- 2) Touch **Alphanumeric** to specify the network No. and PLC station No..

- Alphanumeric** .. Enter the network No. and PLC station No..
- ◀ ▶** Select the input area.
- ←** Set the area value.

In the case of data link systems	
NETWK NO. :	0
STATION :	FF (Host)
	: 0 (Master station)
	: 1 to 64 (Local station)

In the case of network systems	
NETWK NO. :	0 (Host loop)
	: 1 to 255 (Specified loop)
STATION :	FF (Host)
	: 0 (Station number of management station)
	: 1 to 64 (Normal station)

For Ethernet connection *1	
NETWK NO. :	1 to 239
STATION :	1 to 64

CC-Link system	
NETWK NO. :	0
STATION :	0 (master station)

*1 The monitor target must be preset using GT Designer.
 For ACPU monitor, specify the network number/station number set on GT Designer.
 Refer to the help of GT Designer for details of the monitor target setting for Ethernet connection.

When the setting is finished, the system configuration of the specified station is displayed.

See Sec. 12.1.6 for operations which come after these operations.

12.1.3 Composition of PC Information screen and key functions (only when QCPU(Q mode) is used)

This section describes the structure of the PC Information screen that is displayed by specifying the QCPU(Q mode) on the System Configuration screen, and the key functions displayed on the screen.

(1) Display

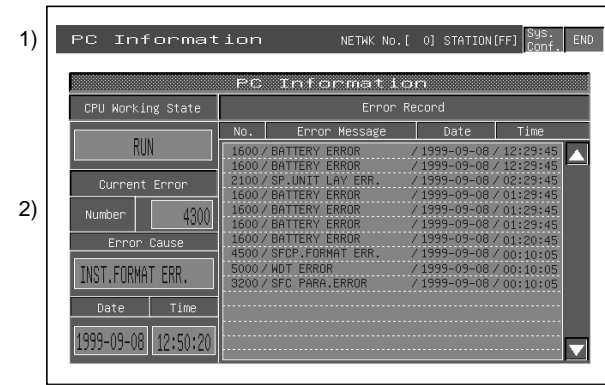

3)

1)	Displays the network number and station number of the monitor station.
2)	Displays the operating status, error information and the like of the corresponding PLC CPU.
3)	The keys used for the operation on the System Configuration screen shown in (2) are displayed. (Touch input)

(2) Key functions

The following table indicates the functions of the keys used to perform operation on the System Configuration screen.

Key	Function
END	Monitoring ends, and the display returns to the screen where the special module monitor function was started.
Sys. Conf.	Shifts to the System Configuration screen. (Refer to Section 12.1.1)
▲ ▼	Scrolls the display one page up or down. ▼: Scrolls one page down. ▲: Scrolls one page up.

12.1.4 Composition of Unit Detail info screen and key functions (only when QCPU(Q mode) is used)

This section describes the structure of the Unit Detail info screen that is displayed by specifying the module in the info. mode of the System Configuration screen, and the key functions displayed on the screen.

(1) Display

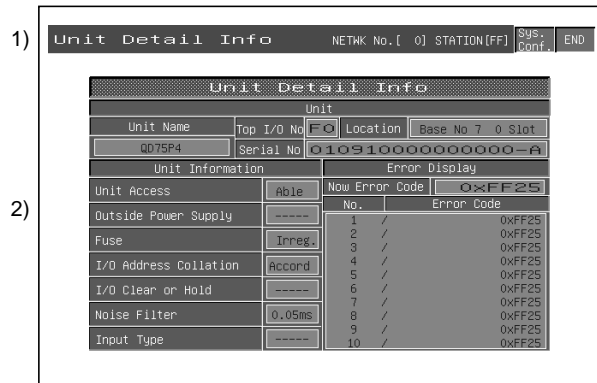

1)	Displays the network number and station number of the monitor station.
2)	Displays the module information, error information and the like of the corresponding module.
3)	The keys used for the operation on the System Configuration screen shown in (2) are displayed. (Touch input)

(2) Key functions

The following table indicates the functions of the keys used to perform operation on the System Configuration screen.

Key	Function
END	Monitoring ends, and the display returns to the screen where the special module monitor function was started.
Sys. Conf.	Shifts to the System Configuration screen. (Refer to Section 12.1.1)
▲ ▼	Scrolls the display one page up or down. ▼ : Scrolls one page down. ▲ : Scrolls one page up.

12.1.5 Monitor screen configuration and key functions

This section describes the structure of the monitor screen that is displayed by specifying the module on the system configuration screen (in the Basic mode when the QCPU(Q mode) is used), and the key functions displayed on the screen.

(1) Display (with A68RD)

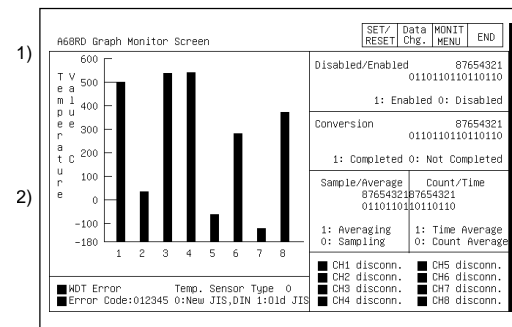

3) All types of data are displayed when the readout from the special function module is complete.
(OS executes it automatically.)

1)	Displays format of module being monitored.
2)	Displays buffer memory data of object module in its current form, or in a graph. Display status of I/O signal with the PLC CPU. When testing, tests after moving the cursor to the display position of the target data.
3)	The keys used for the operation with the monitor screen shown in (2) are displayed. (Touch input)

(2) Key functions

The chart below shows the functions of the keys that are used with the System monitor screen operation.

Key	Function
END	Monitoring ends; and display returns to the screen where the special module monitor function was begun.
MONIT MENU	Ends current monitoring and moves to screen that shows monitor menu. Operation can be used only if the special function module has a Monitor menu.
Data Chg.	Starts change of current values for buffer memory of special function module displayed on screen.
SET/ RESET	Starts test set/reset for I/O signal between PLC CPU and special function module.

12.1.6 Specifying monitor module and selecting monitor menu

The operation when starting the special module monitor for an optional module is explained, using the positioning module (AD71) as an example.

[Operation procedure]

Display System Configuration screen. ... See Sec. 12.1.1.

[Specify module to be monitored] (Touch display position of module.)

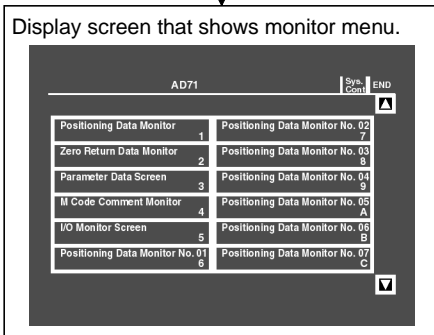

[Specify menu to be monitored] (Touch display position of menu.)

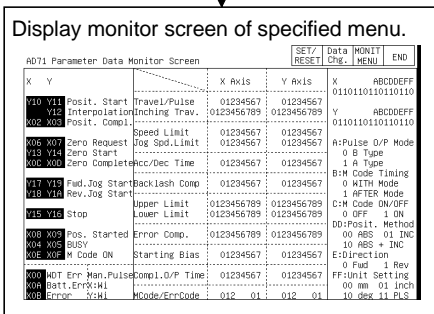

Proceed to Sec. 12.1.7 and Secs. 12.2 to 12.31.

- (1) From among the modules installed in the corresponding base unit, specify the special function module whose format is displayed.
* For modules where the format is not displayed, monitor with the system monitor function (See Sec. 9.5.).
Specify input/output modules according to Sec. 13.1.
- (2) Specify the menu corresponding to the type of data to be monitored.
- (3) With modules for which the monitor menu cannot all be displayed in one screen, touch the ▲ ▼ keys at the right of the screen to scroll the display menu.
- (4) Check the contents of the display. Carry out the subsequent operation according to Sec. 12.2 to 12.31.
- (5) Carry out tests for the displayed data according to Sec. 12.1.7.
 - Change current value of buffer memory
 - Turn output signal from PLC CPU on and off

12.1.7 Test for special function module



CAUTION

- Read the manual carefully and fully understand the operation before the test operation (modifying the current value of a buffer memory) of special function module monitor.
- In addition, never modify data in a test operation to a device which performs a crucial operation to the system. It may cause an accident by a false output or malfunction.

Testing can be performed for all buffer memory data displayed on the current monitor screen. This section describes the operation for changing the current value of the buffer memory and turning the output signal from the PLC CPU to the special module on and off.

POINTS

- (1) When testing, test for the buffer memory to be written in from the PLC CPU and the output signal that is output from the PLC CPU.
- (2) Be sure to carry out the test operation with the PLC CPU in STOP status. If the PLC CPU is tested during RUN status, it returns to the output values and output status from the sequence program.

[Operation procedure]

Display monitor screen.

AD71 Parameter Data Monitor Screen				SET/	Data	MONIT	END
				RESET	CHG.	MENU	
X	Y	X Axis	Y Axis	X	ABCD00FF		
V10	V11	Posit. Start	Travel/Pulse	01234567	01234567	01101101	01101101
V12		Interpolation	Inching Trav.	0123456789	0123456789	Y	ABCD00FF
W02	W03	Posit. Compl.	Speed Limit	01234567	01234567	01101101	01101101
W06	W07	Zero Request	Jog Spd.Limit	01234567	01234567	A:Pulse D/P Mode	
V13	V14	Zero Start	Acc/Dec Time	01234567	01234567	0 B Type	
W0C	W0D	Zero Complet.	Backlash Comp.	01234567	01234567	1 A Type	
V17	V18	Fwd.Jog Start	Upper Limit	0123456789	0123456789	B:M Code Timing	
V19	V16	Rev.Jog Start	Lower Limit	0123456789	0123456789	0 WITH Mode	
V15	V16	Stop	Error Comp.	0123456789	0123456789	C:M Code ON/OFF	
W08	W09	Pos. Started	Starting Bias	01234567	01234567	0 OFF	1 ON
W04	W05	BUSY				DD:Posit. Method	
W0E	W0F	M Code ON				00 ABS	01 INC
W0A	W0T	Err Man.Pulse				10 ABS + INC	
W0B	W0T	Err Man.Pulse				E:Direction	
W0D	W0T	Err Man.Pulse				0 Fwd	1 Rev
W0E	W0T	Err Man.Pulse				FF:Limit Setting	
W0F	W0T	Err Man.Pulse				00 mm	01 Inch
W0B	W0T	Err Man.Pulse				10.000	11 PLS

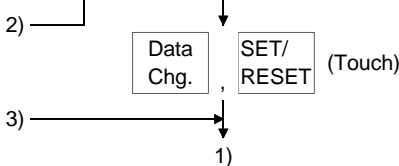

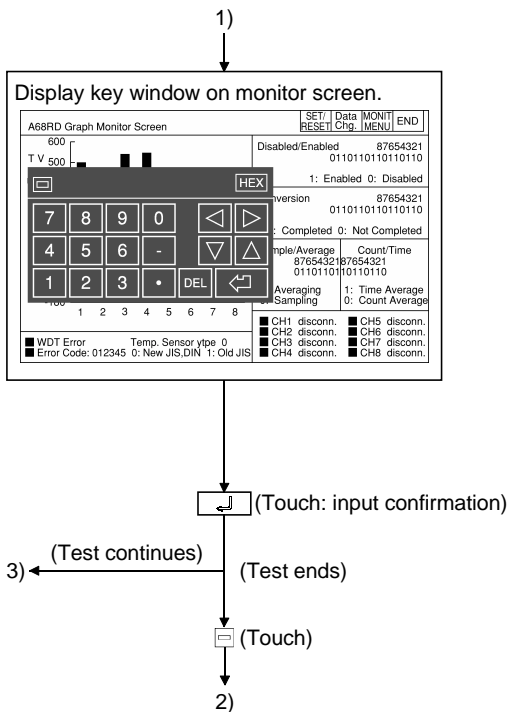

When **Data Chg.** is touched (changes current value of buffer memory)

- All of the following operations can be carried out by touching the keys in the displayed key window.
- When you touch  at the upper left of the key window, the key window closes and the display returns to the monitor screen.

(1) Move the cursor to the position where the data to be tested is displayed. (*1)

(▲ ▼ : Up/down ▶ ◀ : Left/right)

(2) Use the numeric keys to specify the value to be changed. (*2)

The **DEL** key can be used to clear individual characters among those input.

When **SET/RESET** is touched (tests the I/O signal)

- All of the following operations can be carried out by touching the keys in the displayed key window.
- When you touch  at the upper left of the key window, the key window closes and the display returns to the monitor screen.

(1) Use the alphabetic character keys to specify the name of the device to be tested, and then touch . (*1)

(2) Use the numeric keys to specify the device number, and then touch .

(3) Use the numeric keys to specify "Set" or "Reset".

0 : OFF **1** : ON

*1 Do not perform the following tests.

When testing, the module may not operate correctly or the buffer memory/input signal may return to the output value/output status from the special function module.

- 1) Test the buffer memory for reading-only from the PLC CPU.
- 2) Test the input signal to the PLC CPU from the special function module.

*2 When testing buffer memory data, specify the change value in the following way.

- 1) For data where 16/32 bits is displayed with one number, specify the change value in decimal.
- 2) For data where one number of 16/32 bits is displayed as a percent, such as with an A/D conversion module, specify the change value corresponding to the percentage in decimal.

Example:

When the set value of the offset or gain is 0 to 2000, when specifying a change value of 50%, input 1000.

- 3) For data where 16 bits is displayed one bit at a time as "0" and "1", specify the change value of 16 bits in decimal.

12.1.8 Changing the screen

This section describes how to change the screen when executing each monitor function of the special module monitor function from the status where the user-created monitor screen is displayed.

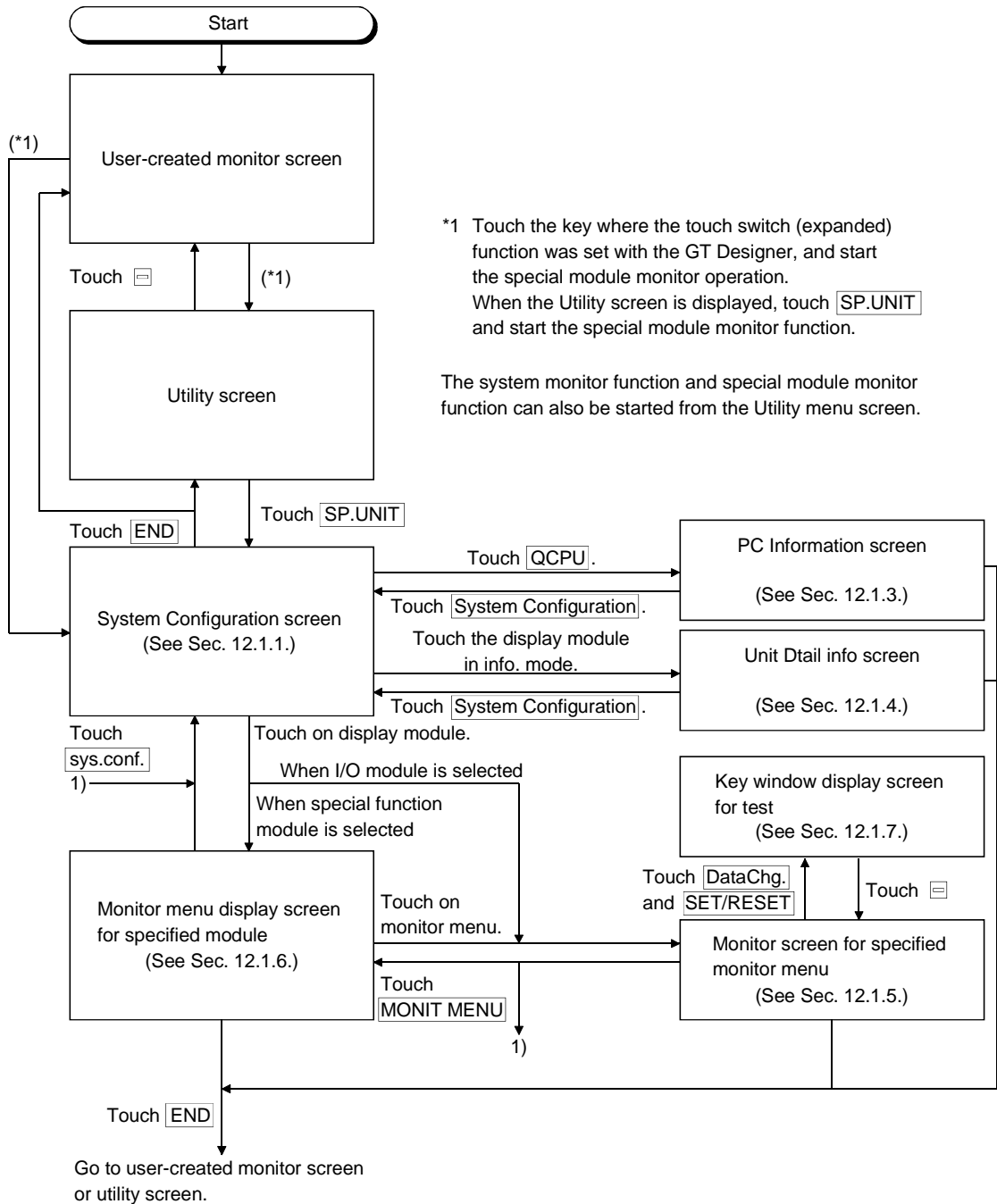

12.2 A61LS Module Monitor

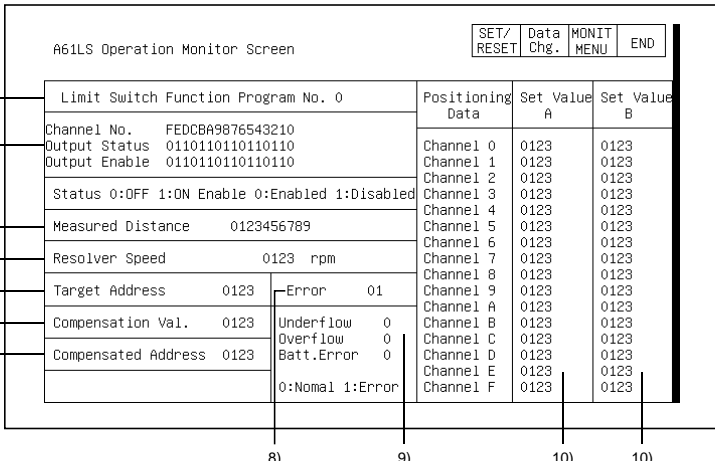
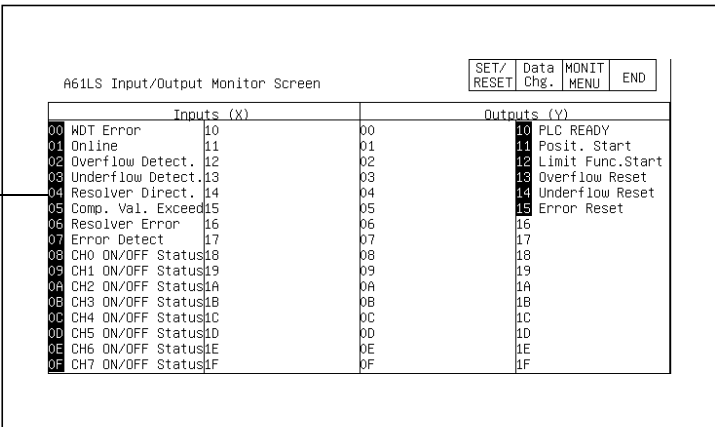
Screen Image		No.	Buffer memory address	
			dec.	hex.
 <p>A61LS Operation Monitor Screen</p> <p>SET/RESET Data Chg. MONIT MENU END</p> <p>Limit Switch Function Program No. 0</p> <p>Channel No. FEDCBA9876543210</p> <p>Output Status 0110110110110110</p> <p>Output Enable 0110110110110110</p> <p>Status 0:OFF 1:ON Enable 0:Enabled 1:Disabled</p> <p>Measured Distance 0123456789</p> <p>Resolver Speed 0123 rpm</p> <p>Target Address 0123 Error 01</p> <p>Compensation Val. 0123 Underflow 0</p> <p>Compensated Address 0123 Overflow 0</p> <p>Batt.Error 0</p> <p>0:Normal 1:Error</p> <p>Positioning Data</p> <p>Set Value A</p> <p>Set Value B</p> <p>Channel 0 0123 0123</p> <p>Channel 1 0123 0123</p> <p>Channel 2 0123 0123</p> <p>Channel 3 0123 0123</p> <p>Channel 4 0123 0123</p> <p>Channel 5 0123 0123</p> <p>Channel 6 0123 0123</p> <p>Channel 7 0123 0123</p> <p>Channel 8 0123 0123</p> <p>Channel 9 0123 0123</p> <p>Channel A 0123 0123</p> <p>Channel B 0123 0123</p> <p>Channel C 0123 0123</p> <p>Channel D 0123 0123</p> <p>Channel E 0123 0123</p> <p>Channel F 0123 0123</p>		1)	11	000B
		2)	4	0004
		3)	10	000A
		4)	5, 6	0005, 0006
		5)	3	0003
		6)	12	000C
		7)	7	0007
		8)	0	0000
		9)	8	0008
		10)	2	0002
		11)	1	0001
		12)	9	0009
		13)	13 to 44	000D to 002C
		—	—	—
 <p>A61LS Input/Output Monitor Screen</p> <p>SET/RESET Data Chg. MONIT MENU END</p> <p>Inputs (X)</p> <p>00 MDT Error 10</p> <p>01 Online 11</p> <p>02 Overflow Detect. 12</p> <p>03 Underflow Detect. 13</p> <p>04 Resolver Direct. 14</p> <p>05 Comp. Val. Exceed 15</p> <p>06 Resolver Error 16</p> <p>07 Error Detect 17</p> <p>08 CH0 ON/OFF Status 18</p> <p>09 CH1 ON/OFF Status 19</p> <p>0A CH2 ON/OFF Status 1A</p> <p>0B CH3 ON/OFF Status 1B</p> <p>0C CH4 ON/OFF Status 1C</p> <p>0D CH5 ON/OFF Status 1D</p> <p>0E CH6 ON/OFF Status 1E</p> <p>0F CH7 ON/OFF Status 1F</p> <p>Outputs (Y)</p> <p>10 PLC READY</p> <p>11 Posit. Start</p> <p>12 Limit Func.Start</p> <p>13 Overflow Reset</p> <p>14 Underflow Reset</p> <p>15 Error Reset</p> <p>16</p> <p>17</p> <p>18</p> <p>19</p> <p>1A</p> <p>1B</p> <p>1C</p> <p>1D</p> <p>1E</p> <p>1F</p>		1)	—	—
		—	—	—

12.3 AD61 Module Monitor

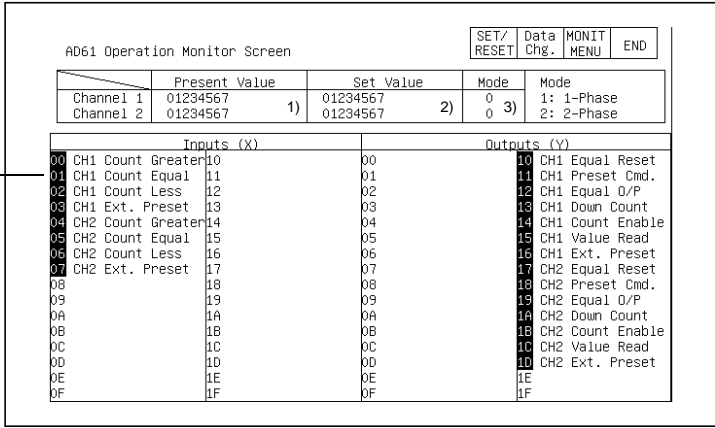
Screen Image		No.	Buffer memory address	
			dec.	hex.
 <p>AD61 Operation Monitor Screen</p> <p>SET/RESET Data Chg. MONIT MENU END</p> <p>Present Value</p> <p>Set Value</p> <p>Mode</p> <p>Mode</p> <p>Channel 1 01234567 1) 01234567 2) 0 3) 1: 1-Phase</p> <p>Channel 2 01234567 01234567 0 2) 0 3) 2: 2-Phase</p> <p>Inputs (X)</p> <p>00 CH1 Count Greater 10</p> <p>01 CH1 Count Equal 11</p> <p>02 CH1 Count Less 12</p> <p>03 CH1 Ext. Preset 13</p> <p>04 CH2 Count Greater 14</p> <p>05 CH2 Count Equal 15</p> <p>06 CH2 Count Less 16</p> <p>07 CH2 Ext. Preset 17</p> <p>08</p> <p>09</p> <p>0A</p> <p>0B</p> <p>0C</p> <p>0D</p> <p>0E</p> <p>0F</p> <p>Outputs (Y)</p> <p>10 CH1 Equal Reset</p> <p>11 CH1 Preset Cmd.</p> <p>12 CH1 Equal O/P</p> <p>13 CH1 Down Count</p> <p>14 CH1 Count Enable</p> <p>15 CH1 Value Read</p> <p>16 CH1 Ext. Preset</p> <p>17 CH2 Equal Reset</p> <p>18 CH2 Preset Cmd.</p> <p>19 CH2 Equal O/P</p> <p>1A CH2 Down Count</p> <p>1B CH2 Count Enable</p> <p>1C CH2 Value Read</p> <p>1D CH2 Ext. Preset</p> <p>1E</p> <p>1F</p>		1)	4, 5, 36, 37	0004, 0005, 0024, 0025
		2)	6, 7, 38, 39	0006, 0007, 0026, 0027
		3)	3, 35	0003, 0023
		4)	—	—
		—	—	—

12.4 A1SD61 Module Monitor

Screen Image		No.	Buffer memory address	
			dec.	hex.
<p>A1SD61 Operation Monitor Screen (CH1,2)</p> <p>Y10 Count Enable, Y11 Decremental Count, Y12 Preset Command, Y13 Ring Counter, X0D Sampling/Periodic, X0A External Preset, Y15 Reset Ext. Preset, Y17 Error Reset, MDT Error, Error Code: 012, Dogs, No. of Dogs, Counter Setting: 0, 0: No setting, 1: Latch counter, 2: Sampling counter, 3: Periodic pulse counter, 4: Counter disable, 5) Channel No., 6) LS. O/P Status, 8 7 6 5 4 3 2 1, Pulse I/P Mode 012345, 0: A-Phase I/P and decremental count, 1: A-Phase and B-Phase I/P, 2: 2-Phase I/P X 1, 3: 2-Phase I/P X 2, 4: 2-Phase I/P X 4</p>		1)	—	—
		2)	—	—
		3)	11	000B
		4)	12 to 147	000C to 0093
		5)	12 to 147	000C to 0093
		6)	5	0005
		7)	—	—
		8)	0, 1	0000, 0001
		9)	2, 3	0002, 0003
		10)	6, 7	0006, 0007
		11)	8, 9	0008, 0009
		12)	4	0004
<p>A1SD61 Input/Output Monitor Screen</p> <p>Inputs (X): 00 MDT Error, 01 CH1 LS Output, 02 CH2 LS Output, 03 CH3 LS Output, 04 CH4 LS Output, 05 CH5 LS Output, 06 CH6 LS Output, 07 CH7 LS Output, 08 CH8 LS Output, 09 LS O/P Enable, 0A Ext. Preset, 0B Error Flag, 0C Fuse/Power OFF, 0D Sampling/Period, 0E, 0F</p> <p>Outputs (Y): 10 Count Enable, 11 Decrement Count, 12 Preset Command, 13 Ring Counter, 14 Counter Function, 15 LS Output, 16 Reset Preset, 17 Error Reset, 18, 19, 1A, 1B, 1C, 1D, 1E, 1F</p>		1)	—	—
		—	—	—

12.5 A62DA-S1 Module Monitor

Screen Image	No.	Buffer memory address	
		dec.	hex.
<p>A62DA-S1 Operation Monitor Screen</p> <p>Channel 1 Output: Voltage check 0123, Current check 2) 0123 Channel 2 Output: Voltage check 0123, Current check 2) 0123</p> <p>Inputs (X): 00-0F, 10-1F Outputs (Y): 10-1F, 1B Output Enable</p>	1)	0, 1	0000, 0001
	2)	2 to 5	0002 to 0005
	3)	---	---
<p>A62DA-S1 Graph Monitor Screen</p> <p>Output [%]: 0, 25, 50, 75, 100 Channel 1, Channel 2</p> <p>Under Error, Over Error, WDT Error</p>	1)	0, 1	0000, 0001
	2)	2, 4	0002, 0004
	3)	3, 5	0003, 0005
	4)	---	---

12.6 A1S62DA Module Monitor

Screen Image	No.	Buffer memory address	
		dec.	hex.
<p>A1S62DA Operation Monitor Screen</p> <p>Analog Output Enable/Disable: Channel No. 21, 0110110110110110 Channel 1 Digital I/P: 012345, Channel 2 Digital I/P: 012345</p> <p>WDT Error Flag, D/A Conversion READY Error Flag, CH2 D/A Output Enable Flag, CH1 D/A Output Enable Flag, Error Reset</p> <p>V Output [%]: Channel 1 (1/4000, 1/8000, 1/12000), Channel 2 (1/4000, 1/8000, 1/12000) AC Output [%]: Channel 1 (1/4000, 1/8000, 1/12000), Channel 2 (1/4000, 1/8000, 1/12000)</p> <p>CH1 Check Code 0123, CH2 Check Code 0123, Resolution Setting 0:1:1/4000, 2:1/8000, 3:1/12000</p>	1)	0	0000
	2)	1	0001
	3)	2	0002
	4)	---	---
	5)	1, 2	0001, 0002
	6)		
	7)		
	8)	10	000A
	9)	11	000B
	10)	9	0009
	11)	---	---
	12)	---	---
	13)	---	---

12.7 A62LS Module Monitor

Screen Image		No.	Buffer memory address																																																																																																																																																																																																																																																																															
			dec.	hex.																																																																																																																																																																																																																																																																														
<p>A62LS Operation Monitor Screen CH No.0-3</p> <p>SET/RESET Data Chg. MONIT MENU END</p> <table border="1"> <tr> <td>X10 WDT Error</td> <td>Y21 Posit. Start</td> <td>Y25 LS O/P Enable</td> <td>Sensor BIN Pos.</td> <td>012345</td> </tr> <tr> <td>X11 Online</td> <td>Y22 Posit. Stop</td> <td>Y26 Error Reset</td> <td>Scaling BIN Pos.</td> <td>012345</td> </tr> <tr> <td>X12 Up.Lim Err</td> <td>Y23 Fwd Jog Start</td> <td>Y27 P1 Disable</td> <td>Target Stop Pos.</td> <td>012345</td> </tr> <tr> <td>X13 Lo.Lim Err</td> <td>Y24 Rev Jog Start</td> <td>Y28 P2 Disable</td> <td></td> <td></td> </tr> <tr> <td>X14 Sensor Error</td> <td></td> <td></td> <td></td> <td></td> </tr> <tr> <td>X15 Corre. Err</td> <td>Error Code</td> <td>3) FEDCBA9876543210</td> <td>Prg.No.0</td> <td>Op. Mode 43210</td> </tr> <tr> <td>X16 Posit. Err</td> <td>LS Output</td> <td>0110110110110110</td> <td>A/back 0</td> <td>0110110110110110</td> </tr> <tr> <td>X17 Error</td> <td>LS Setting</td> <td>0110110110110110</td> <td></td> <td></td> </tr> </table> <table border="1"> <thead> <tr> <th>MAX</th> <th>ON</th> <th>CH</th> <th>0</th> <th>OFF</th> <th>MAX</th> <th>ON</th> <th>CH</th> <th>1</th> <th>OFF</th> <th>MAX</th> <th>ON</th> <th>CH</th> <th>2</th> <th>OFF</th> <th>MAX</th> <th>ON</th> <th>CH</th> <th>3</th> <th>OFF</th> </tr> </thead> <tbody> <tr> <td>0</td> <td>012345</td> <td>012345</td> <td>0</td> <td>012345</td> <td>012345</td> <td>0</td> <td>012345</td> <td>012345</td> <td>0</td> <td>012345</td> <td>012345</td> <td>0</td> <td>012345</td> <td>012345</td> <td>0</td> <td>012345</td> <td>012345</td> <td>0</td> <td>012345</td> <td>012345</td> </tr> <tr> <td>1</td> <td>012345</td> <td>012345</td> <td>1</td> <td>012345</td> <td>012345</td> <td>1</td> <td>012345</td> <td>012345</td> <td>1</td> <td>012345</td> <td>012345</td> <td>1</td> <td>012345</td> <td>012345</td> <td>1</td> <td>012345</td> <td>012345</td> <td>1</td> <td>012345</td> <td>012345</td> </tr> <tr> <td>2</td> <td>012345</td> <td>012345</td> <td>2</td> <td>012345</td> <td>012345</td> <td>2</td> <td>012345</td> <td>012345</td> <td>2</td> <td>012345</td> <td>012345</td> <td>2</td> <td>012345</td> <td>012345</td> <td>2</td> <td>012345</td> <td>012345</td> <td>2</td> <td>012345</td> <td>012345</td> </tr> <tr> <td>D</td> <td>012345</td> <td>012345</td> <td>D</td> <td>012345</td> <td>012345</td> <td>D</td> <td>012345</td> <td>012345</td> <td>D</td> <td>012345</td> <td>012345</td> <td>D</td> <td>012345</td> <td>012345</td> <td>D</td> <td>012345</td> <td>012345</td> <td>D</td> <td>012345</td> <td>012345</td> </tr> <tr> <td>0</td> <td>012345</td> <td>012345</td> <td>0</td> <td>012345</td> <td>012345</td> <td>0</td> <td>012345</td> <td>012345</td> <td>0</td> <td>012345</td> <td>012345</td> <td>0</td> <td>012345</td> <td>012345</td> <td>0</td> <td>012345</td> <td>012345</td> <td>0</td> <td>012345</td> <td>012345</td> </tr> <tr> <td>G</td> <td>012345</td> <td>012345</td> <td>G</td> <td>012345</td> <td>012345</td> <td>G</td> <td>012345</td> <td>012345</td> <td>G</td> <td>012345</td> <td>012345</td> <td>G</td> <td>012345</td> <td>012345</td> <td>G</td> <td>012345</td> <td>012345</td> <td>G</td> <td>012345</td> <td>012345</td> </tr> <tr> <td>6</td> <td>012345</td> <td>012345</td> <td>6</td> <td>012345</td> <td>012345</td> <td>6</td> <td>012345</td> <td>012345</td> <td>6</td> <td>012345</td> <td>012345</td> <td>6</td> <td>012345</td> <td>012345</td> <td>6</td> <td>012345</td> <td>012345</td> <td>6</td> <td>012345</td> <td>012345</td> </tr> <tr> <td>7</td> <td>012345</td> <td>012345</td> <td>7</td> <td>012345</td> <td>012345</td> <td>7</td> <td>012345</td> <td>012345</td> <td>7</td> <td>012345</td> <td>012345</td> <td>7</td> <td>012345</td> <td>012345</td> <td>7</td> <td>012345</td> <td>012345</td> <td>7</td> <td>012345</td> <td>012345</td> </tr> <tr> <td>8</td> <td>012345</td> <td>012345</td> <td>8</td> <td>012345</td> <td>012345</td> <td>8</td> <td>012345</td> <td>012345</td> <td>8</td> <td>012345</td> <td>012345</td> <td>8</td> <td>012345</td> <td>012345</td> <td>8</td> <td>012345</td> <td>012345</td> <td>8</td> <td>012345</td> <td>012345</td> </tr> <tr> <td>9</td> <td>012345</td> <td>012345</td> <td>9</td> <td>012345</td> <td>012345</td> <td>9</td> <td>012345</td> <td>012345</td> <td>9</td> <td>012345</td> <td>012345</td> <td>9</td> <td>012345</td> <td>012345</td> <td>9</td> <td>012345</td> <td>012345</td> <td>9</td> <td>012345</td> <td>012345</td> </tr> </tbody> </table>		X10 WDT Error	Y21 Posit. Start	Y25 LS O/P Enable	Sensor BIN Pos.	012345	X11 Online	Y22 Posit. Stop	Y26 Error Reset	Scaling BIN Pos.	012345	X12 Up.Lim Err	Y23 Fwd Jog Start	Y27 P1 Disable	Target Stop Pos.	012345	X13 Lo.Lim Err	Y24 Rev Jog Start	Y28 P2 Disable			X14 Sensor Error					X15 Corre. Err	Error Code	3) FEDCBA9876543210	Prg.No.0	Op. Mode 43210	X16 Posit. Err	LS Output	0110110110110110	A/back 0	0110110110110110	X17 Error	LS Setting	0110110110110110			MAX	ON	CH	0	OFF	MAX	ON	CH	1	OFF	MAX	ON	CH	2	OFF	MAX	ON	CH	3	OFF	0	012345	012345	0	012345	012345	0	012345	012345	0	012345	012345	0	012345	012345	0	012345	012345	0	012345	012345	1	012345	012345	1	012345	012345	1	012345	012345	1	012345	012345	1	012345	012345	1	012345	012345	1	012345	012345	2	012345	012345	2	012345	012345	2	012345	012345	2	012345	012345	2	012345	012345	2	012345	012345	2	012345	012345	D	012345	012345	D	012345	012345	D	012345	012345	D	012345	012345	D	012345	012345	D	012345	012345	D	012345	012345	0	012345	012345	0	012345	012345	0	012345	012345	0	012345	012345	0	012345	012345	0	012345	012345	0	012345	012345	G	012345	012345	G	012345	012345	G	012345	012345	G	012345	012345	G	012345	012345	G	012345	012345	G	012345	012345	6	012345	012345	6	012345	012345	6	012345	012345	6	012345	012345	6	012345	012345	6	012345	012345	6	012345	012345	7	012345	012345	7	012345	012345	7	012345	012345	7	012345	012345	7	012345	012345	7	012345	012345	7	012345	012345	8	012345	012345	8	012345	012345	8	012345	012345	8	012345	012345	8	012345	012345	8	012345	012345	8	012345	012345	9	012345	012345	9	012345	012345	9	012345	012345	9	012345	012345	9	012345	012345	9	012345	012345	9	012345	012345	1)	---	---
		X10 WDT Error	Y21 Posit. Start	Y25 LS O/P Enable	Sensor BIN Pos.	012345																																																																																																																																																																																																																																																																												
		X11 Online	Y22 Posit. Stop	Y26 Error Reset	Scaling BIN Pos.	012345																																																																																																																																																																																																																																																																												
		X12 Up.Lim Err	Y23 Fwd Jog Start	Y27 P1 Disable	Target Stop Pos.	012345																																																																																																																																																																																																																																																																												
		X13 Lo.Lim Err	Y24 Rev Jog Start	Y28 P2 Disable																																																																																																																																																																																																																																																																														
		X14 Sensor Error																																																																																																																																																																																																																																																																																
		X15 Corre. Err	Error Code	3) FEDCBA9876543210	Prg.No.0	Op. Mode 43210																																																																																																																																																																																																																																																																												
		X16 Posit. Err	LS Output	0110110110110110	A/back 0	0110110110110110																																																																																																																																																																																																																																																																												
		X17 Error	LS Setting	0110110110110110																																																																																																																																																																																																																																																																														
		MAX	ON	CH	0	OFF	MAX	ON	CH	1	OFF	MAX	ON	CH	2	OFF	MAX	ON	CH	3	OFF																																																																																																																																																																																																																																																													
		0	012345	012345	0	012345	012345	0	012345	012345	0	012345	012345	0	012345	012345	0	012345	012345	0	012345	012345																																																																																																																																																																																																																																																												
1	012345	012345	1	012345	012345	1	012345	012345	1	012345	012345	1	012345	012345	1	012345	012345	1	012345	012345																																																																																																																																																																																																																																																														
2	012345	012345	2	012345	012345	2	012345	012345	2	012345	012345	2	012345	012345	2	012345	012345	2	012345	012345																																																																																																																																																																																																																																																														
D	012345	012345	D	012345	012345	D	012345	012345	D	012345	012345	D	012345	012345	D	012345	012345	D	012345	012345																																																																																																																																																																																																																																																														
0	012345	012345	0	012345	012345	0	012345	012345	0	012345	012345	0	012345	012345	0	012345	012345	0	012345	012345																																																																																																																																																																																																																																																														
G	012345	012345	G	012345	012345	G	012345	012345	G	012345	012345	G	012345	012345	G	012345	012345	G	012345	012345																																																																																																																																																																																																																																																														
6	012345	012345	6	012345	012345	6	012345	012345	6	012345	012345	6	012345	012345	6	012345	012345	6	012345	012345																																																																																																																																																																																																																																																														
7	012345	012345	7	012345	012345	7	012345	012345	7	012345	012345	7	012345	012345	7	012345	012345	7	012345	012345																																																																																																																																																																																																																																																														
8	012345	012345	8	012345	012345	8	012345	012345	8	012345	012345	8	012345	012345	8	012345	012345	8	012345	012345																																																																																																																																																																																																																																																														
9	012345	012345	9	012345	012345	9	012345	012345	9	012345	012345	9	012345	012345	9	012345	012345	9	012345	012345																																																																																																																																																																																																																																																														
		2)	7	0007																																																																																																																																																																																																																																																																														
		3)	4	0004																																																																																																																																																																																																																																																																														
		4)	2, 3	0002, 0003																																																																																																																																																																																																																																																																														
		5)	0, 1	0000, 0001																																																																																																																																																																																																																																																																														
		6)	10, 11	000A, 000B																																																																																																																																																																																																																																																																														
		7)	9	0009																																																																																																																																																																																																																																																																														
		8)	5	0005																																																																																																																																																																																																																																																																														
		9)	6	0006																																																																																																																																																																																																																																																																														
		10)	12 to 226	000C to 00E2																																																																																																																																																																																																																																																																														
		11)	12 to 226	000C to 00E2																																																																																																																																																																																																																																																																														
			---	---																																																																																																																																																																																																																																																																														
<p>A62LS Input/Output Monitor Screen</p> <p>SET/RESET Data Chg. MONIT MENU END</p> <table border="1"> <thead> <tr> <th colspan="3">Inputs (X)</th> <th colspan="3">Outputs (Y)</th> </tr> </thead> <tbody> <tr> <td>00</td> <td>10</td> <td>WDT Error</td> <td>00</td> <td>10</td> <td>PLC READY</td> </tr> <tr> <td>01</td> <td>11</td> <td>Online</td> <td>01</td> <td>11</td> <td>Posit. Start</td> </tr> <tr> <td>02</td> <td>12</td> <td>Upper Lim.Error</td> <td>02</td> <td>12</td> <td>Posit. Stop</td> </tr> <tr> <td>03</td> <td>13</td> <td>Lower Lim.Error</td> <td>03</td> <td>13</td> <td>Fwd Jog Start</td> </tr> <tr> <td>04</td> <td>14</td> <td>Sensor Error</td> <td>04</td> <td>14</td> <td>Rev Jog Start</td> </tr> <tr> <td>05</td> <td>15</td> <td>Correction Err.</td> <td>05</td> <td>15</td> <td>LS O/P Enable</td> </tr> <tr> <td>06</td> <td>16</td> <td>Position Error</td> <td>06</td> <td>16</td> <td>Error Reset</td> </tr> <tr> <td>07</td> <td>17</td> <td>Error</td> <td>07</td> <td>17</td> <td>P1 Disable</td> </tr> <tr> <td>08</td> <td>18</td> <td>CH 0/8 Status</td> <td>08</td> <td>18</td> <td>P2 Disable</td> </tr> <tr> <td>09</td> <td>19</td> <td>CH 1/9 Status</td> <td>09</td> <td>19</td> <td></td> </tr> <tr> <td>0A</td> <td>1A</td> <td>CH 2/10 Status</td> <td>0A</td> <td>1A</td> <td></td> </tr> <tr> <td>0B</td> <td>1B</td> <td>CH 3/11 Status</td> <td>0B</td> <td>1B</td> <td></td> </tr> <tr> <td>0C</td> <td>1C</td> <td>CH 4/12 Status</td> <td>0C</td> <td>1C</td> <td></td> </tr> <tr> <td>0D</td> <td>1D</td> <td>CH 5/13 Status</td> <td>0D</td> <td>1D</td> <td></td> </tr> <tr> <td>0E</td> <td>1E</td> <td>CH 6/14 Status</td> <td>0E</td> <td>1E</td> <td></td> </tr> <tr> <td>0F</td> <td>1F</td> <td>CH 7/15 Status</td> <td>0F</td> <td>1F</td> <td></td> </tr> </tbody> </table>		Inputs (X)			Outputs (Y)			00	10	WDT Error	00	10	PLC READY	01	11	Online	01	11	Posit. Start	02	12	Upper Lim.Error	02	12	Posit. Stop	03	13	Lower Lim.Error	03	13	Fwd Jog Start	04	14	Sensor Error	04	14	Rev Jog Start	05	15	Correction Err.	05	15	LS O/P Enable	06	16	Position Error	06	16	Error Reset	07	17	Error	07	17	P1 Disable	08	18	CH 0/8 Status	08	18	P2 Disable	09	19	CH 1/9 Status	09	19		0A	1A	CH 2/10 Status	0A	1A		0B	1B	CH 3/11 Status	0B	1B		0C	1C	CH 4/12 Status	0C	1C		0D	1D	CH 5/13 Status	0D	1D		0E	1E	CH 6/14 Status	0E	1E		0F	1F	CH 7/15 Status	0F	1F		1)	---	---																																																																																																																																																																								
		Inputs (X)			Outputs (Y)																																																																																																																																																																																																																																																																													
00	10	WDT Error	00	10	PLC READY																																																																																																																																																																																																																																																																													
01	11	Online	01	11	Posit. Start																																																																																																																																																																																																																																																																													
02	12	Upper Lim.Error	02	12	Posit. Stop																																																																																																																																																																																																																																																																													
03	13	Lower Lim.Error	03	13	Fwd Jog Start																																																																																																																																																																																																																																																																													
04	14	Sensor Error	04	14	Rev Jog Start																																																																																																																																																																																																																																																																													
05	15	Correction Err.	05	15	LS O/P Enable																																																																																																																																																																																																																																																																													
06	16	Position Error	06	16	Error Reset																																																																																																																																																																																																																																																																													
07	17	Error	07	17	P1 Disable																																																																																																																																																																																																																																																																													
08	18	CH 0/8 Status	08	18	P2 Disable																																																																																																																																																																																																																																																																													
09	19	CH 1/9 Status	09	19																																																																																																																																																																																																																																																																														
0A	1A	CH 2/10 Status	0A	1A																																																																																																																																																																																																																																																																														
0B	1B	CH 3/11 Status	0B	1B																																																																																																																																																																																																																																																																														
0C	1C	CH 4/12 Status	0C	1C																																																																																																																																																																																																																																																																														
0D	1D	CH 5/13 Status	0D	1D																																																																																																																																																																																																																																																																														
0E	1E	CH 6/14 Status	0E	1E																																																																																																																																																																																																																																																																														
0F	1F	CH 7/15 Status	0F	1F																																																																																																																																																																																																																																																																														

12.8 A1S62RD Module Monitor

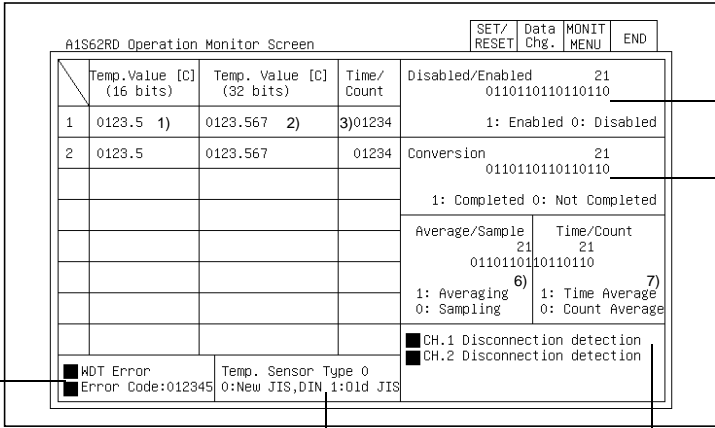
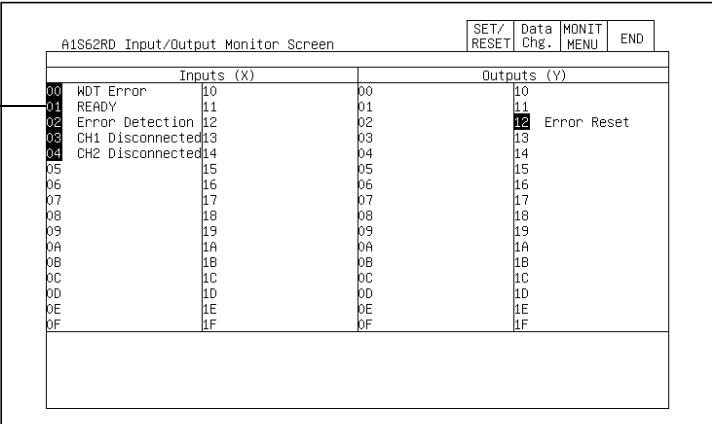
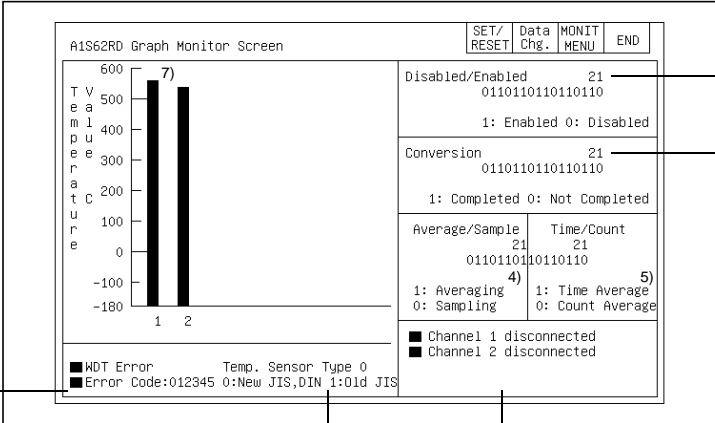
Screen Image		No.	Buffer memory address	
			dec.	hex.
 <p>A1S62RD Operation Monitor Screen</p> <p>Temp. Value [C] (16 bits) Temp. Value [C] (32 bits) Time/Count Disabled/Enabled 21 0110110110110110</p> <p>1: Enabled 0: Disabled</p> <p>Conversion 21 0110110110110110</p> <p>1: Completed 0: Not Completed</p> <p>Average/Sample 21 Time/Count 21 0110110110110110</p> <p>1: Averaging 6) 1: Time Average 7) 0: Sampling 0: Count Average</p> <p>■ CH.1 Disconnection detection ■ CH.2 Disconnection detection</p> <p>■ WDT Error Temp. Sensor Type 0 ■ Error Code:012345 0:New JIS,DIN 1:01d JIS</p>		1)	10, 11	000A, 000B
		2)	18 to 21	0012 to 0015
		3)	2, 3	0002, 0003
		4)	0	0000
		5)	35	0023
		6)	1	0001
		7)	1	0001
		8)	—	—
		9)	34	0022
		10)	36	0024
 <p>A1S62RD Input/Output Monitor Screen</p> <p>Inputs (X) Outputs (Y)</p> <p>00 WDT Error 10 00 10</p> <p>01 READY 11 01 11</p> <p>02 Error Detection 12 02 12 Error Reset</p> <p>03 CH1 Disconnected 13 03 13</p> <p>04 CH2 Disconnected 14 04 14</p> <p>05 15 05 15</p> <p>06 16 06 16</p> <p>07 17 07 17</p> <p>08 18 08 18</p> <p>09 19 09 19</p> <p>0A 1A 0A 1A</p> <p>0B 1B 0B 1B</p> <p>0C 1C 0C 1C</p> <p>0D 1D 0D 1D</p> <p>0E 1E 0E 1E</p> <p>0F 1F 0F 1F</p>		1)	—	—
 <p>A1S62RD Graph Monitor Screen</p> <p>Temp. Value [C] (16 bits) Temp. Value [C] (32 bits) Time/Count Disabled/Enabled 21 0110110110110110</p> <p>1: Enabled 0: Disabled</p> <p>Conversion 21 0110110110110110</p> <p>1: Completed 0: Not Completed</p> <p>Average/Sample 21 Time/Count 21 0110110110110110</p> <p>1: Averaging 4) 1: Time Average 5) 0: Sampling 0: Count Average</p> <p>■ Channel 1 disconnected ■ Channel 2 disconnected</p> <p>■ WDT Error Temp. Sensor Type 0 ■ Error Code:012345 0:New JIS,DIN 1:01d JIS</p>		1)	10, 11	000A, 000B
		2)	0	0000
		3)	35	0023
		4)	1	0001
		5)	1	0001
		6)	—	—
		7)	34	0022
		8)	36	0024

12.9 A1S63ADA Module Monitor

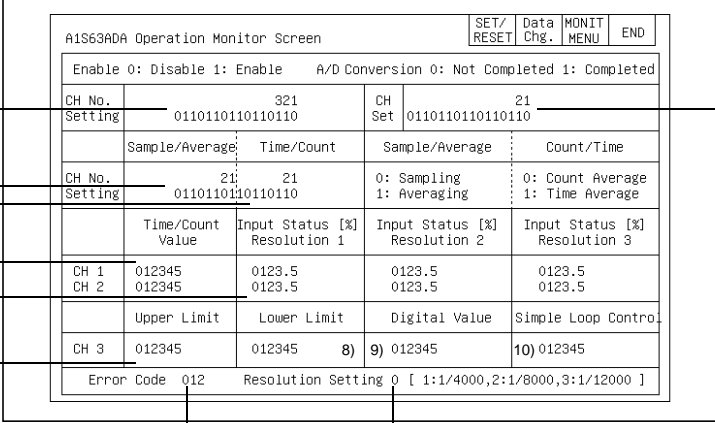
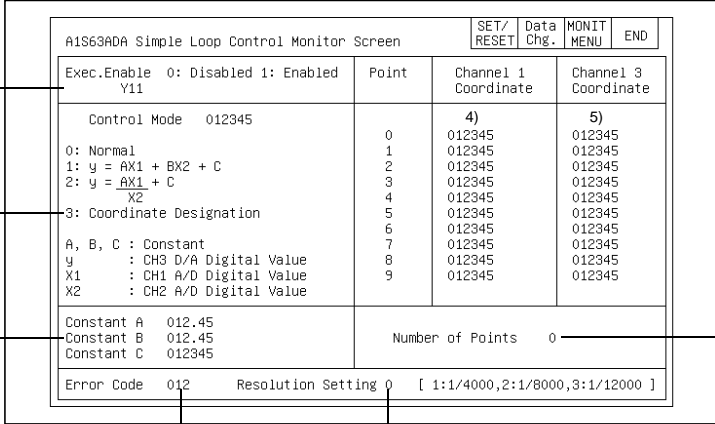
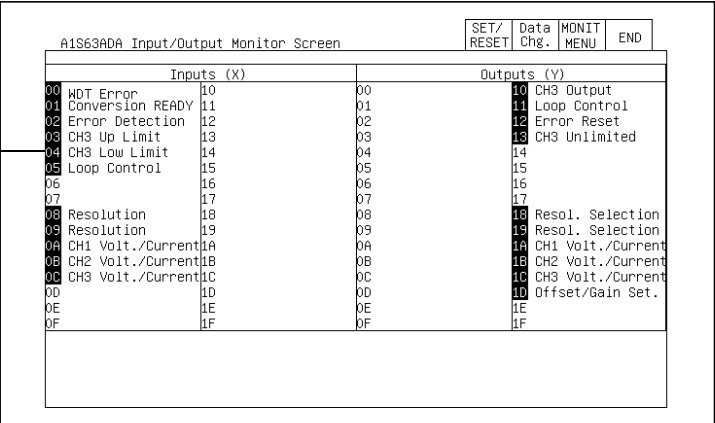
Screen Image		No.	Buffer memory address																																																																							
			dec.	hex.																																																																						
 <p>A1S63ADA Operation Monitor Screen</p> <p>Enable 0: Disable 1: Enable A/D Conversion 0: Not Completed 1: Completed</p> <p>CH No. 321 CH Set 21</p> <p>Setting 0110110110110110 0110110110110110</p> <p>Sample/Average Time/Count Sample/Average Count/Time</p> <p>CH No. 21 21 0: Sampling 0: Count Average</p> <p>Setting 0110110110110110 1: Averaging 1: Time Average</p> <p>Time/Count Value Input Status [%] Resolution 1 Input Status [%] Resolution 2 Input Status [%] Resolution 3</p> <p>CH 1 012345 0123.5 0123.5 0123.5</p> <p>CH 2 012345 0123.5 0123.5 0123.5</p> <p>Upper Limit Lower Limit Digital Value Simple Loop Control</p> <p>CH 3 012345 012345 8) 9) 012345 10) 012345</p> <p>Error Code 012 Resolution Setting 0 [1:1/4000,2:1/8000,3:1/12000]</p> <p>11) 12)</p>		1)	0	0000																																																																						
		2)	15	000F																																																																						
		3)	1	0001																																																																						
		4)	2, 3	0002, 0003																																																																						
		5)	11, 12	000B, 000C																																																																						
		6)	4	0004																																																																						
		7)	5	0005																																																																						
		8)	10	000A																																																																						
		9)	13	000D																																																																						
		10)	16	0010																																																																						
		11)	14	000E																																																																						
		 <p>A1S63ADA Simple Loop Control Monitor Screen</p> <p>Exec.Enable 0: Disabled 1: Enabled Y11</p> <p>Control Mode 012345</p> <p>0: Normal 1: $y = AX1 + BX2 + C$ 2: $y = AX1 + C$ 3: $X2$ 3: Coordinate Designation</p> <p>A, B, C : Constant y : CH3 D/A Digital Value X1 : CH1 A/D Digital Value X2 : CH2 A/D Digital Value</p> <p>Constant A 012.45 Constant B 012.45 Constant C 012345</p> <p>Number of Points 0</p> <p>Error Code 012 Resolution Setting 0 [1:1/4000,2:1/8000,3:1/12000]</p> <p>7) 8)</p>		1)	6	0006																																																																				
2)	7, 8, 9			0007, 0008, 0009																																																																						
3)	18 to 37			0012 to 0025																																																																						
4)	17			0011																																																																						
5)	16			0010																																																																						
6)	14			000E																																																																						
 <p>A1S63ADA Input/Output Monitor Screen</p> <table border="1"> <thead> <tr> <th colspan="2">Inputs (X)</th> <th colspan="2">Outputs (Y)</th> </tr> </thead> <tbody> <tr><td>00</td><td>MDT Error</td><td>10</td><td>CH3 Output</td></tr> <tr><td>01</td><td>Conversion READY</td><td>11</td><td>Loop Control</td></tr> <tr><td>02</td><td>Error Detection</td><td>12</td><td>Error Reset</td></tr> <tr><td>03</td><td>CH3 Up Limit</td><td>13</td><td>CH3 Unlimited</td></tr> <tr><td>04</td><td>CH3 Low Limit</td><td>14</td><td></td></tr> <tr><td>05</td><td>Loop Control</td><td>15</td><td></td></tr> <tr><td>06</td><td></td><td>16</td><td></td></tr> <tr><td>07</td><td></td><td>17</td><td></td></tr> <tr><td>08</td><td>Resolution</td><td>18</td><td>Resol. Selection</td></tr> <tr><td>09</td><td>Resolution</td><td>19</td><td>Resol. Selection</td></tr> <tr><td>0A</td><td>CH1 Volt./Current</td><td>1A</td><td>CH1 Volt./Current</td></tr> <tr><td>0B</td><td>CH2 Volt./Current</td><td>1B</td><td>CH2 Volt./Current</td></tr> <tr><td>0C</td><td>CH3 Volt./Current</td><td>1C</td><td>CH3 Volt./Current</td></tr> <tr><td>0D</td><td></td><td>1D</td><td>Offset/Gain Set.</td></tr> <tr><td>0E</td><td></td><td>1E</td><td></td></tr> <tr><td>0F</td><td></td><td>1F</td><td></td></tr> </tbody> </table>				Inputs (X)		Outputs (Y)		00	MDT Error	10	CH3 Output	01	Conversion READY	11	Loop Control	02	Error Detection	12	Error Reset	03	CH3 Up Limit	13	CH3 Unlimited	04	CH3 Low Limit	14		05	Loop Control	15		06		16		07		17		08	Resolution	18	Resol. Selection	09	Resolution	19	Resol. Selection	0A	CH1 Volt./Current	1A	CH1 Volt./Current	0B	CH2 Volt./Current	1B	CH2 Volt./Current	0C	CH3 Volt./Current	1C	CH3 Volt./Current	0D		1D	Offset/Gain Set.	0E		1E		0F		1F		1)		
				Inputs (X)		Outputs (Y)																																																																				
00	MDT Error	10	CH3 Output																																																																							
01	Conversion READY	11	Loop Control																																																																							
02	Error Detection	12	Error Reset																																																																							
03	CH3 Up Limit	13	CH3 Unlimited																																																																							
04	CH3 Low Limit	14																																																																								
05	Loop Control	15																																																																								
06		16																																																																								
07		17																																																																								
08	Resolution	18	Resol. Selection																																																																							
09	Resolution	19	Resol. Selection																																																																							
0A	CH1 Volt./Current	1A	CH1 Volt./Current																																																																							
0B	CH2 Volt./Current	1B	CH2 Volt./Current																																																																							
0C	CH3 Volt./Current	1C	CH3 Volt./Current																																																																							
0D		1D	Offset/Gain Set.																																																																							
0E		1E																																																																								
0F		1F																																																																								

12.10 A1S64AD Module Monitor

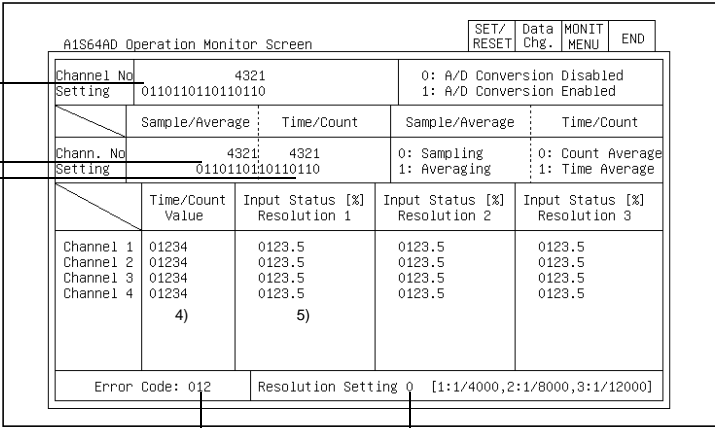
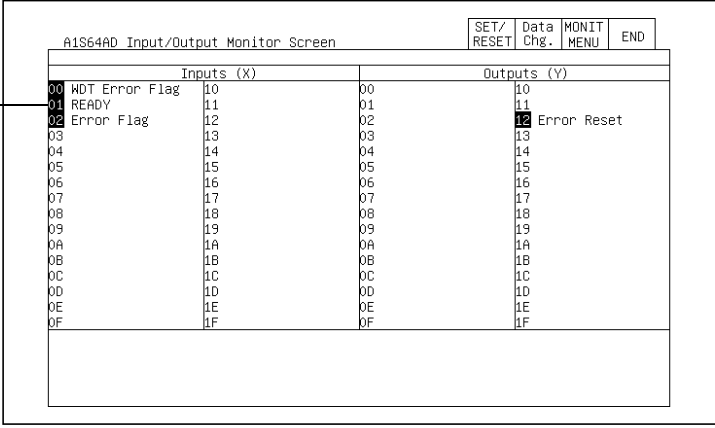
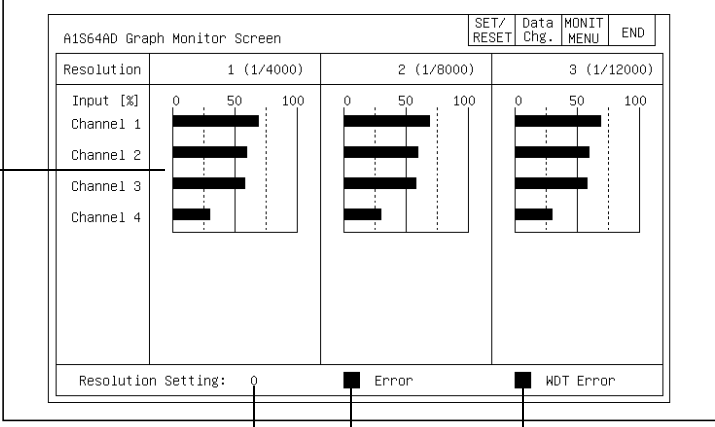
Screen Image		No.	Buffer memory address	
			dec.	hex.
 <p>The screenshot shows the 'A1S64AD Operation Monitor Screen'. It includes fields for Channel No (4321), Setting (0110110110110110), and A/D Conversion status. It also displays a table of input status for four channels, all showing a value of 0123.5. At the bottom, it shows Error Code: 012 and Resolution Setting 0.</p>		1)	0	0000
		2)	1	0001
		3)	1	0001
		4)	2 to 5	0002 to 0005
		5)	10 to 13	000A to 000D
		6)	18	0012
		7)	20	0014
 <p>The screenshot shows the 'A1S64AD Input/Output Monitor Screen'. It displays a table of inputs (X) and outputs (Y) from 00 to 0F. Input 00 is 'WDT Error Flag' and input 02 is 'Error Flag'. Output 0A is 'Error Reset'.</p>		1)	---	---
		---	---	---
 <p>The screenshot shows the 'A1S64AD Graph Monitor Screen'. It features three bar graphs for Resolution 1 (1/4000), Resolution 2 (1/8000), and Resolution 3 (1/12000). Each graph shows input values for Channel 1, 2, 3, and 4. At the bottom, it shows Resolution Setting: 0, Error, and WDT Error indicators.</p>		1)	10 to 13	000A to 000D
		2)	20	0014
		3)	---	---
		4)	---	---

12.11 A68AD Module Monitor

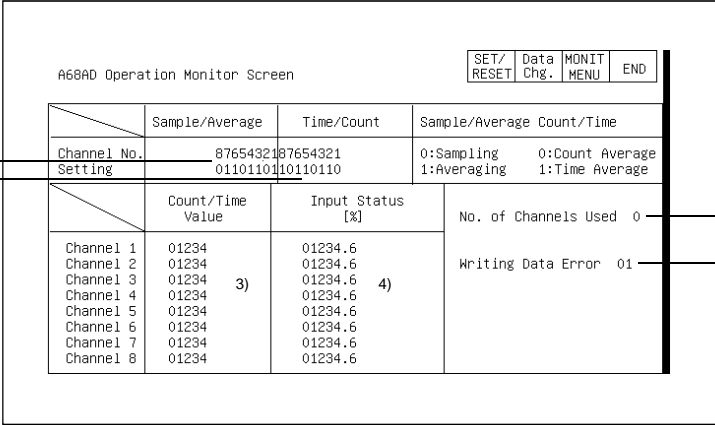
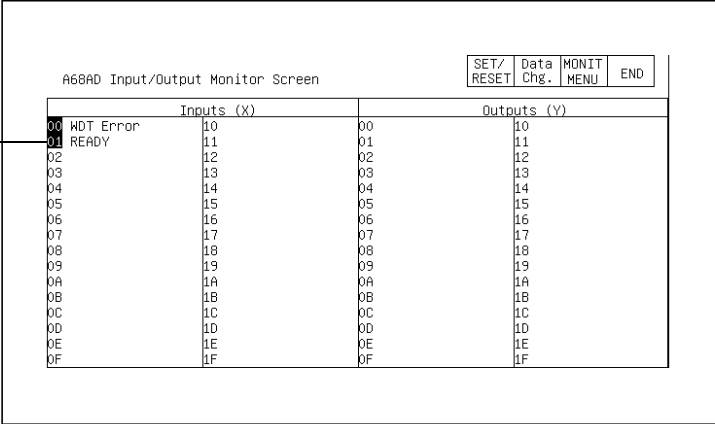
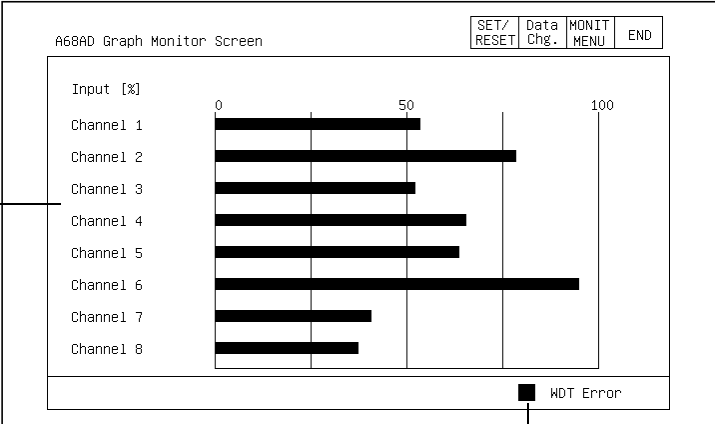
Screen Image		No.	Buffer memory address																																																																					
			dec.	hex.																																																																				
 <p>A68AD Operation Monitor Screen</p> <p>1) Channel No. 87654321 87654321 0:Sampling 0:Count Average</p> <p>2) Setting 01101101 10110110 1:Averaging 1:Time Average</p> <table border="1"> <thead> <tr> <th></th> <th>Sample/Average</th> <th>Time/Count</th> <th>Sample/Average</th> <th>Count/Time</th> </tr> </thead> <tbody> <tr> <td>Channel 1</td> <td>01234</td> <td>01234.6</td> <td>01234</td> <td>01234.6</td> </tr> <tr> <td>Channel 2</td> <td>01234</td> <td>01234.6</td> <td>01234</td> <td>01234.6</td> </tr> <tr> <td>Channel 3</td> <td>01234</td> <td>01234.6</td> <td>01234</td> <td>01234.6</td> </tr> <tr> <td>Channel 4</td> <td>01234</td> <td>01234.6</td> <td>01234</td> <td>01234.6</td> </tr> <tr> <td>Channel 5</td> <td>01234</td> <td>01234.6</td> <td>01234</td> <td>01234.6</td> </tr> <tr> <td>Channel 6</td> <td>01234</td> <td>01234.6</td> <td>01234</td> <td>01234.6</td> </tr> <tr> <td>Channel 7</td> <td>01234</td> <td>01234.6</td> <td>01234</td> <td>01234.6</td> </tr> <tr> <td>Channel 8</td> <td>01234</td> <td>01234.6</td> <td>01234</td> <td>01234.6</td> </tr> </tbody> </table> <p>Count/Time Value: 01234 (3)</p> <p>Input Status [%]: 01234.6 (4)</p> <p>No. of Channels Used: 0 (5)</p> <p>Writing Data Error: 01 (6)</p>			Sample/Average	Time/Count	Sample/Average	Count/Time	Channel 1	01234	01234.6	01234	01234.6	Channel 2	01234	01234.6	01234	01234.6	Channel 3	01234	01234.6	01234	01234.6	Channel 4	01234	01234.6	01234	01234.6	Channel 5	01234	01234.6	01234	01234.6	Channel 6	01234	01234.6	01234	01234.6	Channel 7	01234	01234.6	01234	01234.6	Channel 8	01234	01234.6	01234	01234.6	1)	1	0001																							
			Sample/Average	Time/Count	Sample/Average	Count/Time																																																																		
		Channel 1	01234	01234.6	01234	01234.6																																																																		
		Channel 2	01234	01234.6	01234	01234.6																																																																		
		Channel 3	01234	01234.6	01234	01234.6																																																																		
		Channel 4	01234	01234.6	01234	01234.6																																																																		
Channel 5	01234	01234.6	01234	01234.6																																																																				
Channel 6	01234	01234.6	01234	01234.6																																																																				
Channel 7	01234	01234.6	01234	01234.6																																																																				
Channel 8	01234	01234.6	01234	01234.6																																																																				
2)	1	0001																																																																						
3)	2 to 9	0002 to 0009																																																																						
4)	10 to 17	000A to 0011																																																																						
5)	0	0000																																																																						
6)	34	0022																																																																						
 <p>A68AD Input/Output Monitor Screen</p> <p>1) WDT Error 00</p> <table border="1"> <thead> <tr> <th colspan="2">Inputs (X)</th> <th colspan="2">Outputs (Y)</th> </tr> </thead> <tbody> <tr><td>00</td><td>10</td><td>00</td><td>10</td></tr> <tr><td>01</td><td>11</td><td>01</td><td>11</td></tr> <tr><td>02</td><td>12</td><td>02</td><td>12</td></tr> <tr><td>03</td><td>13</td><td>03</td><td>13</td></tr> <tr><td>04</td><td>14</td><td>04</td><td>14</td></tr> <tr><td>05</td><td>15</td><td>05</td><td>15</td></tr> <tr><td>06</td><td>16</td><td>06</td><td>16</td></tr> <tr><td>07</td><td>17</td><td>07</td><td>17</td></tr> <tr><td>08</td><td>18</td><td>08</td><td>18</td></tr> <tr><td>09</td><td>19</td><td>09</td><td>19</td></tr> <tr><td>0A</td><td>1A</td><td>0A</td><td>1A</td></tr> <tr><td>0B</td><td>1B</td><td>0B</td><td>1B</td></tr> <tr><td>0C</td><td>1C</td><td>0C</td><td>1C</td></tr> <tr><td>0D</td><td>1D</td><td>0D</td><td>1D</td></tr> <tr><td>0E</td><td>1E</td><td>0E</td><td>1E</td></tr> <tr><td>0F</td><td>1F</td><td>0F</td><td>1F</td></tr> </tbody> </table>		Inputs (X)		Outputs (Y)		00	10	00	10	01	11	01	11	02	12	02	12	03	13	03	13	04	14	04	14	05	15	05	15	06	16	06	16	07	17	07	17	08	18	08	18	09	19	09	19	0A	1A	0A	1A	0B	1B	0B	1B	0C	1C	0C	1C	0D	1D	0D	1D	0E	1E	0E	1E	0F	1F	0F	1F	1)	---	---
		Inputs (X)		Outputs (Y)																																																																				
00	10	00	10																																																																					
01	11	01	11																																																																					
02	12	02	12																																																																					
03	13	03	13																																																																					
04	14	04	14																																																																					
05	15	05	15																																																																					
06	16	06	16																																																																					
07	17	07	17																																																																					
08	18	08	18																																																																					
09	19	09	19																																																																					
0A	1A	0A	1A																																																																					
0B	1B	0B	1B																																																																					
0C	1C	0C	1C																																																																					
0D	1D	0D	1D																																																																					
0E	1E	0E	1E																																																																					
0F	1F	0F	1F																																																																					
 <p>A68AD Graph Monitor Screen</p> <p>1) Input [%]</p> <table border="1"> <thead> <tr> <th>Channel</th> <th>Input [%]</th> </tr> </thead> <tbody> <tr><td>Channel 1</td><td>50</td></tr> <tr><td>Channel 2</td><td>75</td></tr> <tr><td>Channel 3</td><td>55</td></tr> <tr><td>Channel 4</td><td>65</td></tr> <tr><td>Channel 5</td><td>65</td></tr> <tr><td>Channel 6</td><td>85</td></tr> <tr><td>Channel 7</td><td>45</td></tr> <tr><td>Channel 8</td><td>45</td></tr> </tbody> </table> <p>2) WDT Error</p>		Channel	Input [%]	Channel 1	50	Channel 2	75	Channel 3	55	Channel 4	65	Channel 5	65	Channel 6	85	Channel 7	45	Channel 8	45	1)	10 to 17	000A to 0011																																																		
		Channel	Input [%]																																																																					
Channel 1	50																																																																							
Channel 2	75																																																																							
Channel 3	55																																																																							
Channel 4	65																																																																							
Channel 5	65																																																																							
Channel 6	85																																																																							
Channel 7	45																																																																							
Channel 8	45																																																																							
2)	---	---																																																																						

12.12 A1S68AD Module Monitor

Screen Image		No.	Buffer memory address																												
			dec.	hex.																											
<p>A1S68AD Movement Monitor Screen</p> <p>1) A/D Conversion 01101101 0: Disabled 1: Enabled</p> <p>2) A/D Method 01101101 0: Sampling 1: Averaging</p> <p>3) Averaging 01101101 0: Number 1: Time</p> <p>4) A/D Conversion 01101101 0: Incomplete 1: Complete</p> <table border="1"> <thead> <tr> <th>CH</th> <th>Averaging Time/Number</th> <th>Input Status [%]</th> </tr> </thead> <tbody> <tr><td>CH 1</td><td>01234</td><td>01234.6</td></tr> <tr><td>CH 2</td><td>01234</td><td>01234.6</td></tr> <tr><td>CH 3</td><td>01234</td><td>01234.6</td></tr> <tr><td>CH 4</td><td>01234</td><td>01234.6</td></tr> <tr><td>CH 5</td><td>5) 01234</td><td>6) 01234.6</td></tr> <tr><td>CH 6</td><td>01234</td><td>01234.6</td></tr> <tr><td>CH 7</td><td>01234</td><td>01234.6</td></tr> <tr><td>CH 8</td><td>01234</td><td>01234.6</td></tr> </tbody> </table> <p>Error Code 012</p> <p>7)</p>		CH	Averaging Time/Number	Input Status [%]	CH 1	01234	01234.6	CH 2	01234	01234.6	CH 3	01234	01234.6	CH 4	01234	01234.6	CH 5	5) 01234	6) 01234.6	CH 6	01234	01234.6	CH 7	01234	01234.6	CH 8	01234	01234.6	1)	0	0000
		CH	Averaging Time/Number	Input Status [%]																											
		CH 1	01234	01234.6																											
		CH 2	01234	01234.6																											
		CH 3	01234	01234.6																											
		CH 4	01234	01234.6																											
		CH 5	5) 01234	6) 01234.6																											
CH 6	01234	01234.6																													
CH 7	01234	01234.6																													
CH 8	01234	01234.6																													
2)	2	0002																													
3)	2	0002																													
4)	28	001C																													
5)	10 to 17	000A to 0011																													
6)	20 to 27	0014 to 001B																													
7)	1	0001																													
<p>A1S68AD Input/Output Monitor Screen</p> <p>1) 00 WDT Error 10 00 Y 10</p> <p>01 Ready 11 01 11</p> <p>02 Error Detect 12 02 08 Error Reset</p> <p>03 13 03 13</p> <p>04 14 04 14</p> <p>05 15 05 15</p> <p>06 16 06 16</p> <p>07 17 07 17</p> <p>08 18 08 18</p> <p>09 19 09 19</p> <p>0A 1A 0A 1A</p> <p>0B 1B 0B 1B</p> <p>0C 1C 0C 1C</p> <p>0D 1D 0D 1D</p> <p>0E 1E 0E 1E</p> <p>0F 1F 0F 1F</p>		1)	---	---																											
		1)	20 to 27	0014 to 001B																											
<p>A1S68AD Graph Monitor Screen</p> <p>1) CH 1 0 5 0</p> <p>CH 2</p> <p>CH 3</p> <p>CH 4 1)</p> <p>CH 5</p> <p>CH 6</p> <p>CH 7 1 0 0</p> <p>CH 8</p> <p>WDT Error</p> <p>2)</p>		2)	---	---																											

12.13 A68ADN Module Monitor

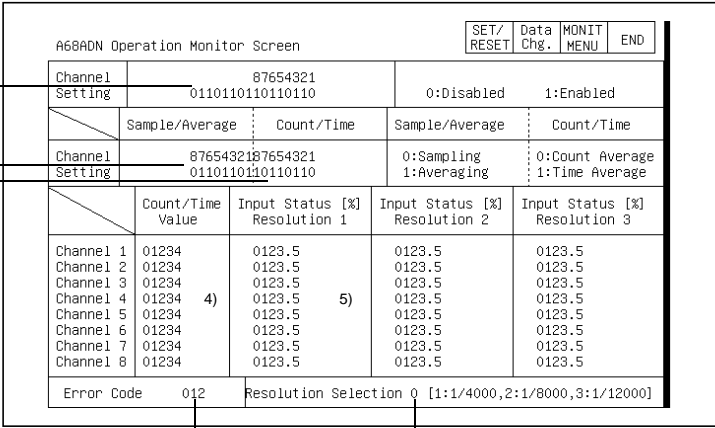
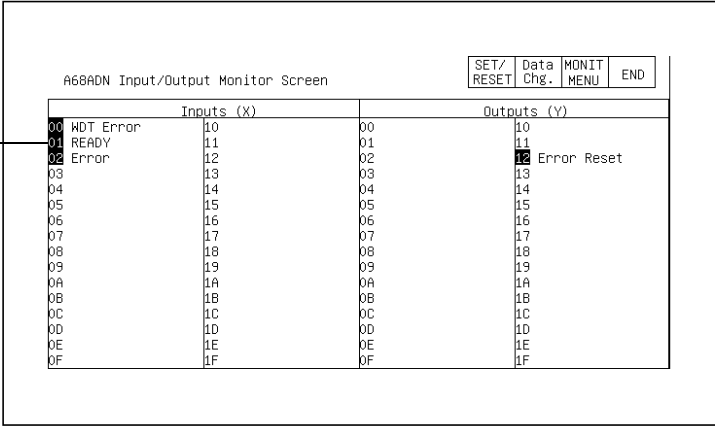
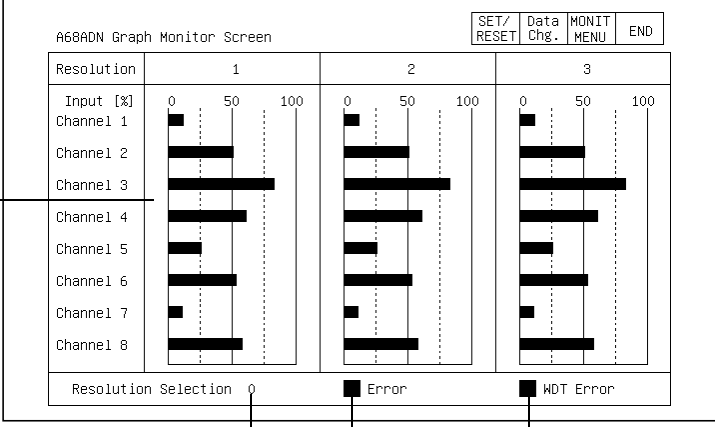
Screen Image		No.	Buffer memory address	
			dec.	hex.
 <p>The screenshot shows the 'A68ADN Operation Monitor Screen'. It includes fields for Channel 1 and Channel 2 settings, sample/average and count/time parameters, and a table of input status for 8 channels. The table shows values like 01234 and 0123.5. There are also error codes and resolution selection options at the bottom.</p>		1)	0	0000
		2)	1	0001
		3)	1	0001
		4)	2 to 9	0002 to 0009
		5)	10 to 17	000A to 0011
		6)	18	0012
		7)	20	0014
 <p>The screenshot shows the 'A68ADN Input/Output Monitor Screen'. It displays a list of inputs (X) and outputs (Y) from 00 to 0F. Input 00 is labeled 'WDT Error' and input 02 is labeled 'Error'. Input 0E is labeled 'Error Reset'.</p>		1)	---	---
		---	---	---
 <p>The screenshot shows the 'A68ADN Graph Monitor Screen'. It features three bar graphs for Resolution 1, 2, and 3, each showing input levels for 8 channels. A legend at the bottom indicates 'Error' and 'WDT Error' with corresponding symbols.</p>		1)	10 to 17	000A to 0011
		2)	20	0014
		3)	---	---
		4)	---	---

12.14 A68RD Module Monitor

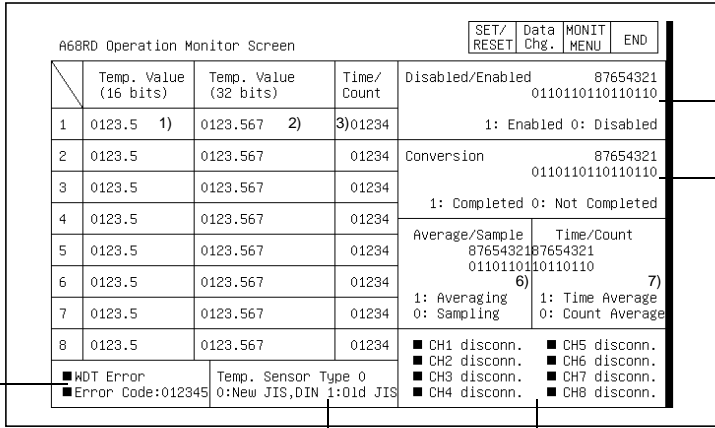
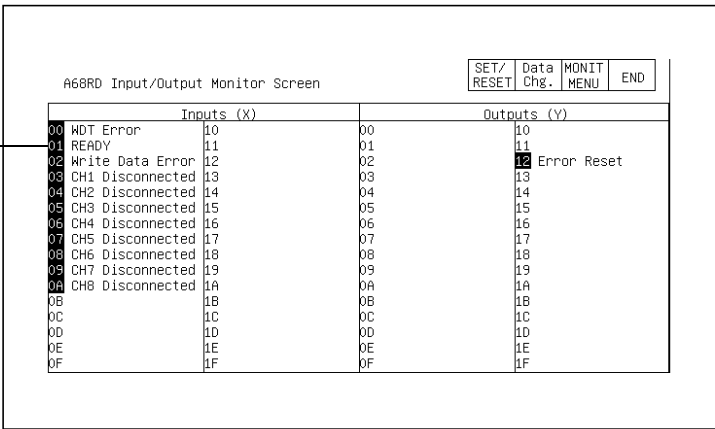
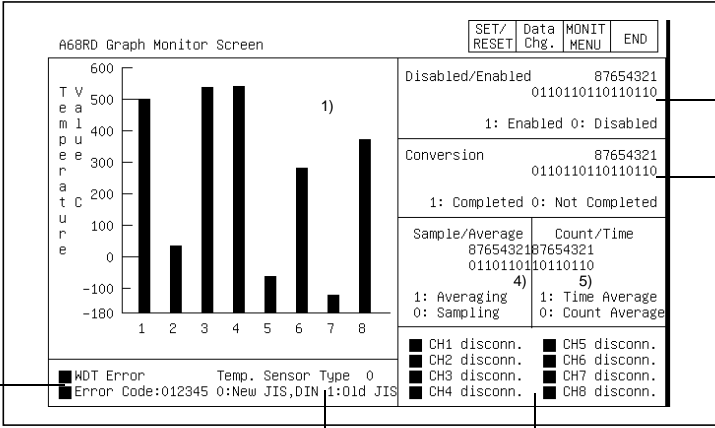
Screen Image	No.	Buffer memory address	
		dec.	hex.
 <p>A68RD Operation Monitor Screen</p> <p>Temp. Value (16 bits) Temp. Value (32 bits) Time/Count</p> <p>1: Enabled 0: Disabled</p> <p>Conversion 87654321</p> <p>Average/Sample Time/Count</p> <p>1: Averaging 0: Sampling 1: Time Average 0: Count Average</p> <p>■ WDT Error Temp. Sensor Type 0</p> <p>■ Error Code:012345 0:New JIS,DIN 1:01d JIS</p>	1)	10 to 17	000A to 0011
	1)	18 to 33	0012 to 0021
	2)	2 to 9	0002 to 0009
	3)	0	0000
	4)	35	0023
	5)	1	0001
	6)	1	0001
	7)	---	---
	8)	34	0022
	9)	36	0024
 <p>A68RD Input/Output Monitor Screen</p> <p>Inputs (X) Outputs (Y)</p> <p>00 WDT Error 10</p> <p>01 READY 11</p> <p>02 Write Data Error 12 Error Reset</p> <p>03 CH1 Disconnected 13</p> <p>04 CH2 Disconnected 14</p> <p>05 CH3 Disconnected 15</p> <p>06 CH4 Disconnected 16</p> <p>07 CH5 Disconnected 17</p> <p>08 CH6 Disconnected 18</p> <p>09 CH7 Disconnected 19</p> <p>0A CH8 Disconnected 1A</p> <p>0B 1B</p> <p>0C 1C</p> <p>0D 1D</p> <p>0E 1E</p> <p>0F 1F</p>	1)	---	---
	---	---	---
 <p>A68RD Graph Monitor Screen</p> <p>Temperature</p> <p>Disabled/Enabled 87654321</p> <p>Conversion 87654321</p> <p>Sample/Average Count/Time</p> <p>1: Averaging 0: Sampling 1: Time Average 0: Count Average</p> <p>■ WDT Error Temp. Sensor Type 0</p> <p>■ Error Code:012345 0:New JIS,DIN 1:01d JIS</p>	1)	10 to 17	000A to 0011
	2)	0	0000
	3)	35	0023
	4)	1	0001
	5)	1	0001
	6)	---	---
	7)	34	0022
	8)	36	0024
---	---	---	

12.15 A1S68DAI,A1S68DAV Module Monitor

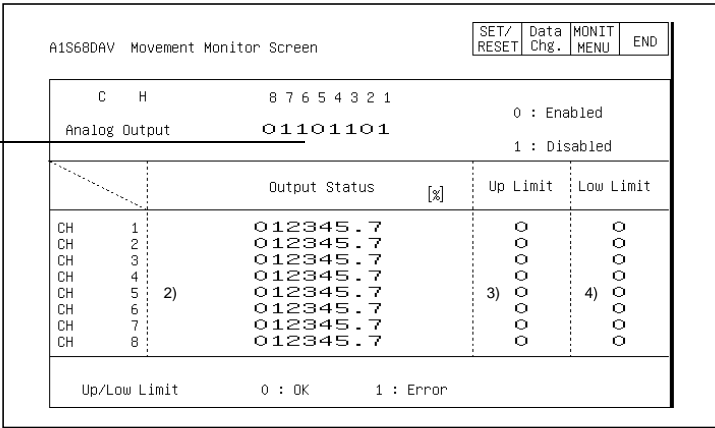
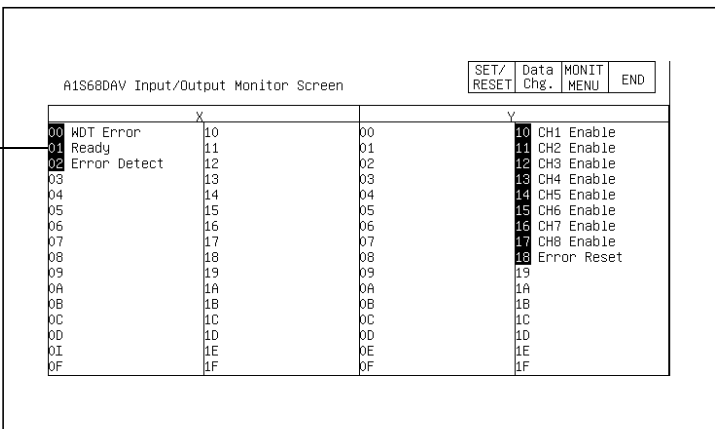
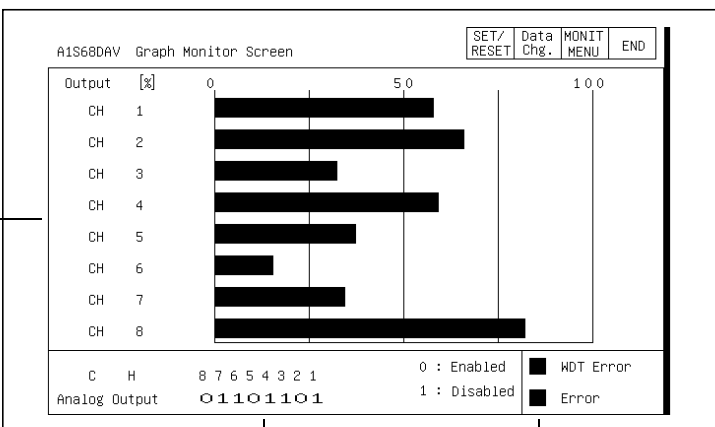
Screen Image	No.	Buffer memory address																																																																																		
		dec.	hex.																																																																																	
 <p>A1S68DAV Movement Monitor Screen</p> <p>SET/RESET Data Chg. MONIT MENU END</p> <p>C H 8 7 6 5 4 3 2 1 0 : Enabled</p> <p>Analog Output 01101101 1 : Disabled</p> <table border="1"> <thead> <tr> <th>CH</th> <th>1</th> <th>Output Status [%]</th> <th>Up Limit</th> <th>Low Limit</th> </tr> </thead> <tbody> <tr><td>CH 1</td><td>1</td><td>012345.7</td><td>0</td><td>0</td></tr> <tr><td>CH 2</td><td>2</td><td>012345.7</td><td>0</td><td>0</td></tr> <tr><td>CH 3</td><td>3</td><td>012345.7</td><td>0</td><td>0</td></tr> <tr><td>CH 4</td><td>4</td><td>012345.7</td><td>0</td><td>0</td></tr> <tr><td>CH 5</td><td>2)</td><td>012345.7</td><td>3)</td><td>4)</td></tr> <tr><td>CH 6</td><td>6</td><td>012345.7</td><td>0</td><td>0</td></tr> <tr><td>CH 7</td><td>7</td><td>012345.7</td><td>0</td><td>0</td></tr> <tr><td>CH 8</td><td>8</td><td>012345.7</td><td>0</td><td>0</td></tr> </tbody> </table> <p>Up/Low Limit 0 : OK 1 : Error</p>	CH	1	Output Status [%]	Up Limit	Low Limit	CH 1	1	012345.7	0	0	CH 2	2	012345.7	0	0	CH 3	3	012345.7	0	0	CH 4	4	012345.7	0	0	CH 5	2)	012345.7	3)	4)	CH 6	6	012345.7	0	0	CH 7	7	012345.7	0	0	CH 8	8	012345.7	0	0	1)	0	0000																																				
	CH	1	Output Status [%]	Up Limit	Low Limit																																																																															
	CH 1	1	012345.7	0	0																																																																															
	CH 2	2	012345.7	0	0																																																																															
CH 3	3	012345.7	0	0																																																																																
CH 4	4	012345.7	0	0																																																																																
CH 5	2)	012345.7	3)	4)																																																																																
CH 6	6	012345.7	0	0																																																																																
CH 7	7	012345.7	0	0																																																																																
CH 8	8	012345.7	0	0																																																																																
	2)	1 to 8	0001 to 0008																																																																																	
	3)	10 to 17	000A to 0011																																																																																	
	4)	10 to 17	000A to 0011																																																																																	
 <p>A1S68DAV Input/Output Monitor Screen</p> <p>SET/RESET Data Chg. MONIT MENU END</p> <table border="1"> <thead> <tr> <th>X</th> <th>Y</th> </tr> </thead> <tbody> <tr><td>00 WDT Error</td><td>10 CH1 Enable</td></tr> <tr><td>01 Ready</td><td>11 CH2 Enable</td></tr> <tr><td>02 Error Detect</td><td>12 CH3 Enable</td></tr> <tr><td>03</td><td>13 CH4 Enable</td></tr> <tr><td>04</td><td>14 CH5 Enable</td></tr> <tr><td>05</td><td>15 CH6 Enable</td></tr> <tr><td>06</td><td>16 CH7 Enable</td></tr> <tr><td>07</td><td>17 CH8 Enable</td></tr> <tr><td>08</td><td>18 Error Reset</td></tr> <tr><td>09</td><td>19</td></tr> <tr><td>0A</td><td>1A</td></tr> <tr><td>0B</td><td>1B</td></tr> <tr><td>0C</td><td>1C</td></tr> <tr><td>0D</td><td>1D</td></tr> <tr><td>0E</td><td>1E</td></tr> <tr><td>0F</td><td>1F</td></tr> </tbody> </table>	X	Y	00 WDT Error	10 CH1 Enable	01 Ready	11 CH2 Enable	02 Error Detect	12 CH3 Enable	03	13 CH4 Enable	04	14 CH5 Enable	05	15 CH6 Enable	06	16 CH7 Enable	07	17 CH8 Enable	08	18 Error Reset	09	19	0A	1A	0B	1B	0C	1C	0D	1D	0E	1E	0F	1F	1)	---	---																																															
	X	Y																																																																																		
00 WDT Error	10 CH1 Enable																																																																																			
01 Ready	11 CH2 Enable																																																																																			
02 Error Detect	12 CH3 Enable																																																																																			
03	13 CH4 Enable																																																																																			
04	14 CH5 Enable																																																																																			
05	15 CH6 Enable																																																																																			
06	16 CH7 Enable																																																																																			
07	17 CH8 Enable																																																																																			
08	18 Error Reset																																																																																			
09	19																																																																																			
0A	1A																																																																																			
0B	1B																																																																																			
0C	1C																																																																																			
0D	1D																																																																																			
0E	1E																																																																																			
0F	1F																																																																																			
 <p>A1S68DAV Graph Monitor Screen</p> <p>SET/RESET Data Chg. MONIT MENU END</p> <p>Output [%] 0 50 100</p> <table border="1"> <thead> <tr> <th>CH</th> <th>1</th> <th>2</th> <th>3</th> <th>4</th> <th>5</th> <th>6</th> <th>7</th> <th>8</th> </tr> </thead> <tbody> <tr><td>CH 1</td><td>50</td><td>60</td><td>70</td><td>80</td><td>90</td><td>100</td><td>110</td><td>120</td></tr> <tr><td>CH 2</td><td>60</td><td>70</td><td>80</td><td>90</td><td>100</td><td>110</td><td>120</td><td>130</td></tr> <tr><td>CH 3</td><td>70</td><td>80</td><td>90</td><td>100</td><td>110</td><td>120</td><td>130</td><td>140</td></tr> <tr><td>CH 4</td><td>80</td><td>90</td><td>100</td><td>110</td><td>120</td><td>130</td><td>140</td><td>150</td></tr> <tr><td>CH 5</td><td>90</td><td>100</td><td>110</td><td>120</td><td>130</td><td>140</td><td>150</td><td>160</td></tr> <tr><td>CH 6</td><td>100</td><td>110</td><td>120</td><td>130</td><td>140</td><td>150</td><td>160</td><td>170</td></tr> <tr><td>CH 7</td><td>110</td><td>120</td><td>130</td><td>140</td><td>150</td><td>160</td><td>170</td><td>180</td></tr> <tr><td>CH 8</td><td>120</td><td>130</td><td>140</td><td>150</td><td>160</td><td>170</td><td>180</td><td>190</td></tr> </tbody> </table> <p>C H 8 7 6 5 4 3 2 1 0 : Enabled ■ WDT Error</p> <p>Analog Output 01101101 1 : Disabled ■ Error</p>	CH	1	2	3	4	5	6	7	8	CH 1	50	60	70	80	90	100	110	120	CH 2	60	70	80	90	100	110	120	130	CH 3	70	80	90	100	110	120	130	140	CH 4	80	90	100	110	120	130	140	150	CH 5	90	100	110	120	130	140	150	160	CH 6	100	110	120	130	140	150	160	170	CH 7	110	120	130	140	150	160	170	180	CH 8	120	130	140	150	160	170	180	190	1)	1 to 8	0001 to 0008
	CH	1	2	3	4	5	6	7	8																																																																											
	CH 1	50	60	70	80	90	100	110	120																																																																											
	CH 2	60	70	80	90	100	110	120	130																																																																											
CH 3	70	80	90	100	110	120	130	140																																																																												
CH 4	80	90	100	110	120	130	140	150																																																																												
CH 5	90	100	110	120	130	140	150	160																																																																												
CH 6	100	110	120	130	140	150	160	170																																																																												
CH 7	110	120	130	140	150	160	170	180																																																																												
CH 8	120	130	140	150	160	170	180	190																																																																												
	2)	0	0000																																																																																	
	3)	---	---																																																																																	
	4)	10 to 17	000A to 0011																																																																																	

12.16 A616AD Module Monitor

Screen Image		No.	Buffer memory address																																																																																	
			dec.	hex.																																																																																
<p>A616AD Operation Monitor Screen</p> <p>1) Enable FEDCBA9876543210 0110110110110110 0: Disabled 1: Enabled</p> <p>2) Data Format Setting FEDCBA9876543210 0110110110110110</p> <p>3) Input Status For Data Format 0: Refer to left hand side values. Format 1: Refer to right hand side values.</p> <table border="1"> <tr><td>CH 0</td><td>01234.6</td><td>01234.6</td><td>CH 8</td><td>01234.6</td><td>01234.6</td></tr> <tr><td>CH 1</td><td>01234.6</td><td>01234.6</td><td>CH 9</td><td>01234.6</td><td>01234.6</td></tr> <tr><td>CH 2</td><td>01234.6</td><td>01234.6</td><td>CH A</td><td>01234.6</td><td>01234.6</td></tr> <tr><td>CH 3</td><td>01234.6</td><td>01234.6</td><td>CH B</td><td>01234.6</td><td>01234.6</td></tr> <tr><td>CH 4</td><td>01234.6</td><td>01234.6</td><td>CH C</td><td>01234.6</td><td>01234.6</td></tr> <tr><td>CH 5</td><td>01234.6</td><td>01234.6</td><td>CH D</td><td>01234.6</td><td>01234.6</td></tr> <tr><td>CH 6</td><td>01234.6</td><td>01234.6</td><td>CH E</td><td>01234.6</td><td>01234.6</td></tr> <tr><td>CH 7</td><td>01234.6</td><td>01234.6</td><td>CH F</td><td>01234.6</td><td>01234.6</td></tr> </table> <p>Direct Access INPUT CH:0 MX CH:0 I/P: 01234.6 01234.6</p> <p>6) 7)</p>		CH 0	01234.6	01234.6	CH 8	01234.6	01234.6	CH 1	01234.6	01234.6	CH 9	01234.6	01234.6	CH 2	01234.6	01234.6	CH A	01234.6	01234.6	CH 3	01234.6	01234.6	CH B	01234.6	01234.6	CH 4	01234.6	01234.6	CH C	01234.6	01234.6	CH 5	01234.6	01234.6	CH D	01234.6	01234.6	CH 6	01234.6	01234.6	CH E	01234.6	01234.6	CH 7	01234.6	01234.6	CH F	01234.6	01234.6	1)	15	000F																																
		CH 0	01234.6	01234.6	CH 8	01234.6	01234.6																																																																													
		CH 1	01234.6	01234.6	CH 9	01234.6	01234.6																																																																													
		CH 2	01234.6	01234.6	CH A	01234.6	01234.6																																																																													
		CH 3	01234.6	01234.6	CH B	01234.6	01234.6																																																																													
		CH 4	01234.6	01234.6	CH C	01234.6	01234.6																																																																													
		CH 5	01234.6	01234.6	CH D	01234.6	01234.6																																																																													
CH 6	01234.6	01234.6	CH E	01234.6	01234.6																																																																															
CH 7	01234.6	01234.6	CH F	01234.6	01234.6																																																																															
2)	4	0004																																																																																		
3)	48 to 63	0030 to 003F																																																																																		
4)	5	0005																																																																																		
5)	3	0003																																																																																		
6)	0	0000																																																																																		
7)	2	0002																																																																																		
<p>A616AD Operation Monitor Screen CONNECT No.0</p> <p>1) Enable FEDCBA9876543210 0110110110110110 0: Disabled 1: Enabled</p> <p>3) Data Format Setting * 0110110110110110</p> <p>4) Input Status For Data Format 0: Refer to left hand side values. Format 1: Refer to right hand side values.</p> <table border="1"> <tr><td>CH 0</td><td>01234.6</td><td>01234.6</td><td>CH 8</td><td>01234.6</td><td>01234.6</td></tr> <tr><td>CH 1</td><td>01234.6</td><td>01234.6</td><td>CH 9</td><td>01234.6</td><td>01234.6</td></tr> <tr><td>CH 2</td><td>01234.6</td><td>01234.6</td><td>CH A</td><td>01234.6</td><td>01234.6</td></tr> <tr><td>CH 3</td><td>01234.6</td><td>01234.6</td><td>CH B</td><td>01234.6</td><td>01234.6</td></tr> <tr><td>CH 4</td><td>01234.6</td><td>01234.6</td><td>CH C</td><td>01234.6</td><td>01234.6</td></tr> <tr><td>CH 5</td><td>01234.6</td><td>01234.6</td><td>CH D</td><td>01234.6</td><td>01234.6</td></tr> <tr><td>CH 6</td><td>01234.6</td><td>01234.6</td><td>CH E</td><td>01234.6</td><td>01234.6</td></tr> <tr><td>CH 7</td><td>01234.6</td><td>01234.6</td><td>CH F</td><td>01234.6</td><td>01234.6</td></tr> </table> <p>Direct Access INPUT CH:0 MX CH:0 I/P :01234.6 01234.6</p> <p>8) 9)</p>		CH 0	01234.6	01234.6	CH 8	01234.6	01234.6	CH 1	01234.6	01234.6	CH 9	01234.6	01234.6	CH 2	01234.6	01234.6	CH A	01234.6	01234.6	CH 3	01234.6	01234.6	CH B	01234.6	01234.6	CH 4	01234.6	01234.6	CH C	01234.6	01234.6	CH 5	01234.6	01234.6	CH D	01234.6	01234.6	CH 6	01234.6	01234.6	CH E	01234.6	01234.6	CH 7	01234.6	01234.6	CH F	01234.6	01234.6	2)	16 to 23	0010 to 0017																																
		CH 0	01234.6	01234.6	CH 8	01234.6	01234.6																																																																													
		CH 1	01234.6	01234.6	CH 9	01234.6	01234.6																																																																													
		CH 2	01234.6	01234.6	CH A	01234.6	01234.6																																																																													
		CH 3	01234.6	01234.6	CH B	01234.6	01234.6																																																																													
		CH 4	01234.6	01234.6	CH C	01234.6	01234.6																																																																													
		CH 5	01234.6	01234.6	CH D	01234.6	01234.6																																																																													
		CH 6	01234.6	01234.6	CH E	01234.6	01234.6																																																																													
		CH 7	01234.6	01234.6	CH F	01234.6	01234.6																																																																													
3)	4	0004																																																																																		
4)	256 to 383	0100 to 017F																																																																																		
5)	5	0005																																																																																		
6)	6	0006																																																																																		
7)	3	0003																																																																																		
8)	1	0001																																																																																		
9)	2	0002																																																																																		
<p>A616AD Input/Output Monitor Screen</p> <p>1) Inputs (X) Outputs (Y)</p> <table border="1"> <tr><td>00</td><td>HDT Error</td><td>10</td><td>00</td><td>10</td></tr> <tr><td>01</td><td>READY</td><td>11</td><td>01</td><td>11</td></tr> <tr><td>02</td><td>Error</td><td>12</td><td>02</td><td>12</td></tr> <tr><td>03</td><td></td><td>13</td><td>03</td><td>13</td></tr> <tr><td>04</td><td></td><td>14</td><td>04</td><td>14</td></tr> <tr><td>05</td><td></td><td>15</td><td>05</td><td>15</td></tr> <tr><td>06</td><td></td><td>16</td><td>06</td><td>16</td></tr> <tr><td>07</td><td></td><td>17</td><td>07</td><td>17</td></tr> <tr><td>08</td><td></td><td>18</td><td>08</td><td>18</td></tr> <tr><td>09</td><td></td><td>19</td><td>09</td><td>19</td></tr> <tr><td>0A</td><td></td><td>1A</td><td>0A</td><td>1A</td></tr> <tr><td>0B</td><td></td><td>1B</td><td>0B</td><td>1B</td></tr> <tr><td>0C</td><td></td><td>1C</td><td>0C</td><td>1C</td></tr> <tr><td>0D</td><td></td><td>1D</td><td>0D</td><td>1D</td></tr> <tr><td>0E</td><td></td><td>1E</td><td>0E</td><td>1E</td></tr> <tr><td>0F</td><td></td><td>1F</td><td>0F</td><td>1F</td></tr> </table> <p>16 Direct Access</p>		00	HDT Error	10	00	10	01	READY	11	01	11	02	Error	12	02	12	03		13	03	13	04		14	04	14	05		15	05	15	06		16	06	16	07		17	07	17	08		18	08	18	09		19	09	19	0A		1A	0A	1A	0B		1B	0B	1B	0C		1C	0C	1C	0D		1D	0D	1D	0E		1E	0E	1E	0F		1F	0F	1F	1)		
00	HDT Error	10	00	10																																																																																
01	READY	11	01	11																																																																																
02	Error	12	02	12																																																																																
03		13	03	13																																																																																
04		14	04	14																																																																																
05		15	05	15																																																																																
06		16	06	16																																																																																
07		17	07	17																																																																																
08		18	08	18																																																																																
09		19	09	19																																																																																
0A		1A	0A	1A																																																																																
0B		1B	0B	1B																																																																																
0C		1C	0C	1C																																																																																
0D		1D	0D	1D																																																																																
0E		1E	0E	1E																																																																																
0F		1F	0F	1F																																																																																

Screen Image	No.	Buffer memory address	
		dec.	hex.
<p>A616AD Graph Monitor Screen</p> <p>Input [%] 0/0 50 100/50 100</p> <p>Channel 0 Channel 1 Channel 2 Channel 3 Channel 4 Channel 5 Channel 6 Channel 7 Channel 8 Channel 9 Channel A Channel B Channel C Channel D Channel E Channel F</p> <p>Scale A (0): Data Format 0 Scale B (0): Data Format 1</p> <p>■ MDT Error ■ Error</p> <p>FEDCBA9876543210 Data Format 0110110110110110 Enable 0110110110110110 0: Disabled 1: Enabled</p>	1)	48 to 63	0030 to 003F
	2)	---	---
	3)	4	0004
<p>A616AD Graph Monitor Screen CONNECT No. 0</p> <p>Input [%] 0/0 50 100/50 100</p> <p>Channel 0 Channel 1 Channel 2 Channel 3 Channel 4 Channel 5 Channel 6 Channel 7 Channel 8 Channel 9 Channel A Channel B Channel C Channel D Channel E Channel F</p> <p>Scale A (0): Data Format 0 Scale B (0): Data Format 1</p> <p>■ MDT Error ■ Error</p> <p>Connect No. * Channel No. FEDCBA9876543210 Data Format 0110110110110110 Enable 0110110110110110 0: Disabled 1: Enabled</p>	1)	---	---
	2)	256 to 383	0100 to 017F
	3)	---	---
	4)	4	0004
		16 to 23	0010 to 0017

12.17 A616DAI,A616DAV Module Monitor

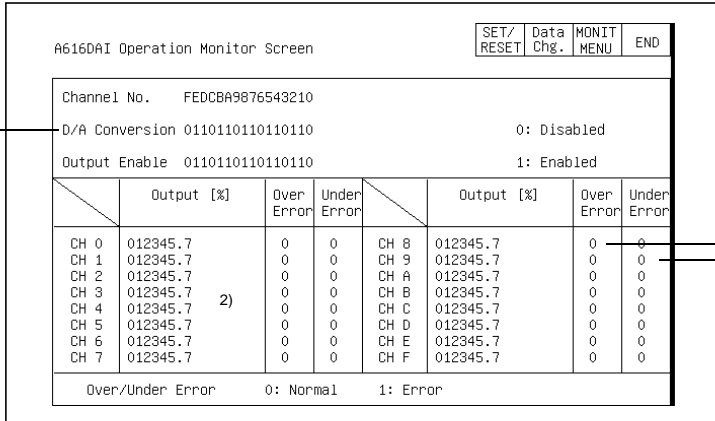
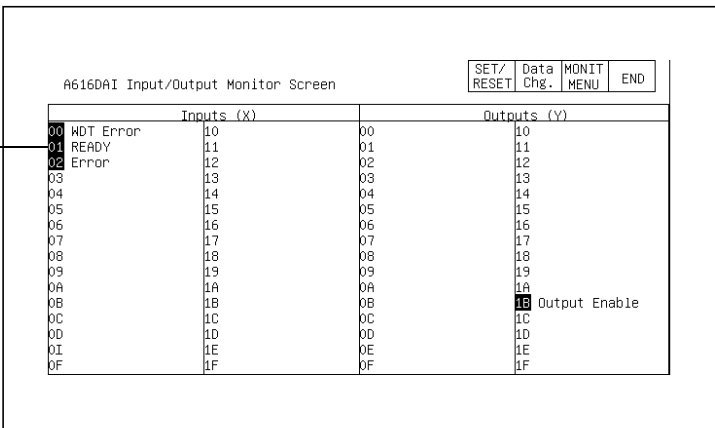
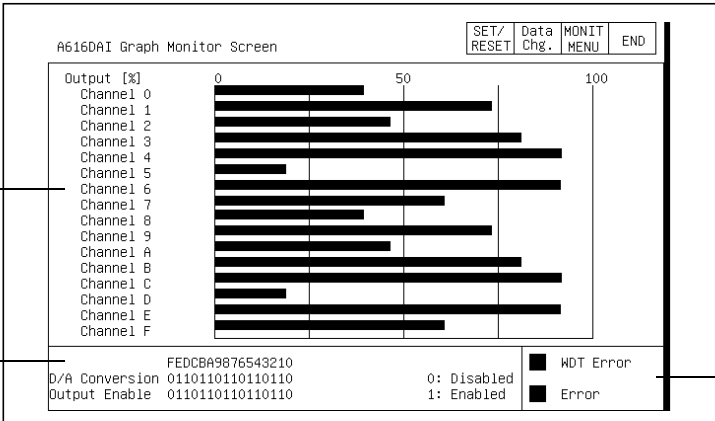
Screen Image	No.	Buffer memory address																																																																									
		dec.	hex.																																																																								
 <p>A616DAI Operation Monitor Screen</p> <p>Channel No. FEDCBA9876543210</p> <p>D/A Conversion 0110110110110110 0: Disabled</p> <p>Output Enable 0110110110110110 1: Enabled</p> <table border="1"> <thead> <tr> <th></th> <th>Output [%]</th> <th>Over Error</th> <th>Under Error</th> <th></th> <th>Output [%]</th> <th>Over Error</th> <th>Under Error</th> </tr> </thead> <tbody> <tr><td>CH 0</td><td>012345.7</td><td>0</td><td>0</td><td>CH 8</td><td>012345.7</td><td>0</td><td>0</td></tr> <tr><td>CH 1</td><td>012345.7</td><td>0</td><td>0</td><td>CH 9</td><td>012345.7</td><td>0</td><td>0</td></tr> <tr><td>CH 2</td><td>012345.7</td><td>0</td><td>0</td><td>CH A</td><td>012345.7</td><td>0</td><td>0</td></tr> <tr><td>CH 3</td><td>012345.7</td><td>0</td><td>0</td><td>CH B</td><td>012345.7</td><td>0</td><td>0</td></tr> <tr><td>CH 4</td><td>012345.7</td><td>0</td><td>0</td><td>CH C</td><td>012345.7</td><td>0</td><td>0</td></tr> <tr><td>CH 5</td><td>012345.7</td><td>0</td><td>0</td><td>CH D</td><td>012345.7</td><td>0</td><td>0</td></tr> <tr><td>CH 6</td><td>012345.7</td><td>0</td><td>0</td><td>CH E</td><td>012345.7</td><td>0</td><td>0</td></tr> <tr><td>CH 7</td><td>012345.7</td><td>0</td><td>0</td><td>CH F</td><td>012345.7</td><td>0</td><td>0</td></tr> </tbody> </table> <p>Over/Under Error 0: Normal 1: Error</p>		Output [%]	Over Error	Under Error		Output [%]	Over Error	Under Error	CH 0	012345.7	0	0	CH 8	012345.7	0	0	CH 1	012345.7	0	0	CH 9	012345.7	0	0	CH 2	012345.7	0	0	CH A	012345.7	0	0	CH 3	012345.7	0	0	CH B	012345.7	0	0	CH 4	012345.7	0	0	CH C	012345.7	0	0	CH 5	012345.7	0	0	CH D	012345.7	0	0	CH 6	012345.7	0	0	CH E	012345.7	0	0	CH 7	012345.7	0	0	CH F	012345.7	0	0	1)	0	0000
		Output [%]	Over Error	Under Error		Output [%]	Over Error	Under Error																																																																			
	CH 0	012345.7	0	0	CH 8	012345.7	0	0																																																																			
	CH 1	012345.7	0	0	CH 9	012345.7	0	0																																																																			
CH 2	012345.7	0	0	CH A	012345.7	0	0																																																																				
CH 3	012345.7	0	0	CH B	012345.7	0	0																																																																				
CH 4	012345.7	0	0	CH C	012345.7	0	0																																																																				
CH 5	012345.7	0	0	CH D	012345.7	0	0																																																																				
CH 6	012345.7	0	0	CH E	012345.7	0	0																																																																				
CH 7	012345.7	0	0	CH F	012345.7	0	0																																																																				
	2)	—	0010 to 001F																																																																								
	3)	48 to 63	0030 to 003F																																																																								
	4)	48 to 63	0030 to 003F																																																																								
 <p>A616DAI Input/Output Monitor Screen</p> <table border="1"> <thead> <tr> <th colspan="2">Inputs (X)</th> <th colspan="2">Outputs (Y)</th> </tr> </thead> <tbody> <tr><td>00 WDT Error</td><td>10</td><td>00</td><td>10</td></tr> <tr><td>01 READY</td><td>11</td><td>01</td><td>11</td></tr> <tr><td>02 Error</td><td>12</td><td>02</td><td>12</td></tr> <tr><td>03</td><td>13</td><td>03</td><td>13</td></tr> <tr><td>04</td><td>14</td><td>04</td><td>14</td></tr> <tr><td>05</td><td>15</td><td>05</td><td>15</td></tr> <tr><td>06</td><td>16</td><td>06</td><td>16</td></tr> <tr><td>07</td><td>17</td><td>07</td><td>17</td></tr> <tr><td>08</td><td>18</td><td>08</td><td>18</td></tr> <tr><td>09</td><td>19</td><td>09</td><td>19</td></tr> <tr><td>0A</td><td>1A</td><td>0A</td><td>1A</td></tr> <tr><td>0B</td><td>1B</td><td>0B</td><td>1B Output Enable</td></tr> <tr><td>0C</td><td>1C</td><td>0C</td><td>1C</td></tr> <tr><td>0D</td><td>1D</td><td>0D</td><td>1D</td></tr> <tr><td>0E</td><td>1E</td><td>0E</td><td>1E</td></tr> <tr><td>0F</td><td>1F</td><td>0F</td><td>1F</td></tr> </tbody> </table>	Inputs (X)		Outputs (Y)		00 WDT Error	10	00	10	01 READY	11	01	11	02 Error	12	02	12	03	13	03	13	04	14	04	14	05	15	05	15	06	16	06	16	07	17	07	17	08	18	08	18	09	19	09	19	0A	1A	0A	1A	0B	1B	0B	1B Output Enable	0C	1C	0C	1C	0D	1D	0D	1D	0E	1E	0E	1E	0F	1F	0F	1F	1)	—	—				
	Inputs (X)		Outputs (Y)																																																																								
00 WDT Error	10	00	10																																																																								
01 READY	11	01	11																																																																								
02 Error	12	02	12																																																																								
03	13	03	13																																																																								
04	14	04	14																																																																								
05	15	05	15																																																																								
06	16	06	16																																																																								
07	17	07	17																																																																								
08	18	08	18																																																																								
09	19	09	19																																																																								
0A	1A	0A	1A																																																																								
0B	1B	0B	1B Output Enable																																																																								
0C	1C	0C	1C																																																																								
0D	1D	0D	1D																																																																								
0E	1E	0E	1E																																																																								
0F	1F	0F	1F																																																																								
 <p>A616DAI Graph Monitor Screen</p> <p>Output [%] 0 50 100</p> <p>Channel 0 Channel 1 Channel 2 Channel 3 Channel 4 Channel 5 Channel 6 Channel 7 Channel 8 Channel 9 Channel A Channel B Channel C Channel D Channel E Channel F</p> <p>D/A Conversion 0110110110110110 0: Disabled</p> <p>Output Enable 0110110110110110 1: Enabled</p> <p>Legend: ■ WDT Error, ■ Error</p>	1)	16 to 31	10 to 1F																																																																								
	2)	0	0																																																																								
	3)	1	1																																																																								

12.18 A616TD Module Monitor

Screen Image		No.	Buffer memory address	
			dec.	hex.
		1)	15	000F
		2)	0	0000
		3)	1	0001
		4)	2	0002
		5)	4	0004
		6)	112 to 127	0070 to 007F
		7)	---	---
		8)	---	---
		9)	---	---
		1)	---	---
		2)	16 to 23	0010 to 0017
		3)	0	0000
		4)	384 to 511	0180 to 01FF
		5)	80 to 87	0050 to 0057
		6)	96 to 103	0060 to 0067
		7)	64 to 71	0040 to 0047
		8)	32 to 39	0020 to 0027
		9)	512 to 639	0200 to 027F
		10)	48 to 63	0030 to 003F
		11)	---	---
		1)	---	---

Screen Image	No.	Buffer memory address																																																																																																																																																	
		dec.	hex.																																																																																																																																																
<p>A616TD Setting Monitor Screen</p> <table border="1"> <thead> <tr> <th></th> <th>CNT No.0</th> <th>CNT No.1</th> <th>CNT No.2</th> <th>CNT No.3</th> <th>CNT No.4</th> <th>CNT No.5</th> <th>CNT No.6</th> <th>CNT No.7</th> </tr> </thead> <tbody> <tr><td>CH 1</td><td>01234</td><td>01234</td><td>01234</td><td>01234</td><td>01234</td><td>01234</td><td>01234</td><td>01234</td></tr> <tr><td>CH 2</td><td>01234</td><td>01234</td><td>01234</td><td>01234</td><td>01234</td><td>01234</td><td>01234</td><td>01234</td></tr> <tr><td>CH 3</td><td>01234</td><td>01234</td><td>01234</td><td>01234</td><td>01234</td><td>01234</td><td>01234</td><td>01234</td></tr> <tr><td>CH 4</td><td>01234</td><td>01234</td><td>01234</td><td>01234</td><td>01234</td><td>01234</td><td>01234</td><td>01234</td></tr> <tr><td>CH 5</td><td>01234</td><td>01234</td><td>01234</td><td>01234</td><td>01234</td><td>01234</td><td>01234</td><td>01234</td></tr> <tr><td>CH 6</td><td>01234</td><td>01234</td><td>01234</td><td>01234</td><td>01234</td><td>01234</td><td>01234</td><td>01234</td></tr> <tr><td>CH 7</td><td>01234</td><td>01234</td><td>01234</td><td>01234</td><td>01234</td><td>01234</td><td>01234</td><td>01234</td></tr> <tr><td>CH 8</td><td>01234</td><td>01234</td><td>01234</td><td>01234</td><td>01234</td><td>01234</td><td>01234</td><td>01234</td></tr> <tr><td>CH 9</td><td>01234</td><td>01234</td><td>01234</td><td>01234</td><td>01234</td><td>01234</td><td>01234</td><td>01234</td></tr> <tr><td>CH A</td><td>01234</td><td>01234</td><td>01234</td><td>01234</td><td>01234</td><td>01234</td><td>01234</td><td>01234</td></tr> <tr><td>CH B</td><td>01234</td><td>01234</td><td>01234</td><td>01234</td><td>01234</td><td>01234</td><td>01234</td><td>01234</td></tr> <tr><td>CH C</td><td>01234</td><td>01234</td><td>01234</td><td>01234</td><td>01234</td><td>01234</td><td>01234</td><td>01234</td></tr> <tr><td>CH D</td><td>01234</td><td>01234</td><td>01234</td><td>01234</td><td>01234</td><td>01234</td><td>01234</td><td>01234</td></tr> <tr><td>CH E</td><td>01234</td><td>01234</td><td>01234</td><td>01234</td><td>01234</td><td>01234</td><td>01234</td><td>01234</td></tr> <tr><td>CH F</td><td>01234</td><td>01234</td><td>01234</td><td>01234</td><td>01234</td><td>01234</td><td>01234</td><td>01234</td></tr> </tbody> </table> <p>Col. A: Err. Comp. Value Error Code If Error Code 70 Col. B: Sensor Type [01] Wrong Sensor Type CNT No. 0 MX CH 0</p> <p>1) 2) 3) 4)</p>		CNT No.0	CNT No.1	CNT No.2	CNT No.3	CNT No.4	CNT No.5	CNT No.6	CNT No.7	CH 1	01234	01234	01234	01234	01234	01234	01234	01234	CH 2	01234	01234	01234	01234	01234	01234	01234	01234	CH 3	01234	01234	01234	01234	01234	01234	01234	01234	CH 4	01234	01234	01234	01234	01234	01234	01234	01234	CH 5	01234	01234	01234	01234	01234	01234	01234	01234	CH 6	01234	01234	01234	01234	01234	01234	01234	01234	CH 7	01234	01234	01234	01234	01234	01234	01234	01234	CH 8	01234	01234	01234	01234	01234	01234	01234	01234	CH 9	01234	01234	01234	01234	01234	01234	01234	01234	CH A	01234	01234	01234	01234	01234	01234	01234	01234	CH B	01234	01234	01234	01234	01234	01234	01234	01234	CH C	01234	01234	01234	01234	01234	01234	01234	01234	CH D	01234	01234	01234	01234	01234	01234	01234	01234	CH E	01234	01234	01234	01234	01234	01234	01234	01234	CH F	01234	01234	01234	01234	01234	01234	01234	01234	1)	256 to 383	0100 to 017F
		CNT No.0	CNT No.1	CNT No.2	CNT No.3	CNT No.4	CNT No.5	CNT No.6	CNT No.7																																																																																																																																										
	CH 1	01234	01234	01234	01234	01234	01234	01234	01234																																																																																																																																										
	CH 2	01234	01234	01234	01234	01234	01234	01234	01234																																																																																																																																										
CH 3	01234	01234	01234	01234	01234	01234	01234	01234																																																																																																																																											
CH 4	01234	01234	01234	01234	01234	01234	01234	01234																																																																																																																																											
CH 5	01234	01234	01234	01234	01234	01234	01234	01234																																																																																																																																											
CH 6	01234	01234	01234	01234	01234	01234	01234	01234																																																																																																																																											
CH 7	01234	01234	01234	01234	01234	01234	01234	01234																																																																																																																																											
CH 8	01234	01234	01234	01234	01234	01234	01234	01234																																																																																																																																											
CH 9	01234	01234	01234	01234	01234	01234	01234	01234																																																																																																																																											
CH A	01234	01234	01234	01234	01234	01234	01234	01234																																																																																																																																											
CH B	01234	01234	01234	01234	01234	01234	01234	01234																																																																																																																																											
CH C	01234	01234	01234	01234	01234	01234	01234	01234																																																																																																																																											
CH D	01234	01234	01234	01234	01234	01234	01234	01234																																																																																																																																											
CH E	01234	01234	01234	01234	01234	01234	01234	01234																																																																																																																																											
CH F	01234	01234	01234	01234	01234	01234	01234	01234																																																																																																																																											
	2)	128 to 255	0080 to 00FF																																																																																																																																																
	3)	1	0001																																																																																																																																																
	4)	3	0003																																																																																																																																																
<p>A616TD Temperature Monitor Screen CONNECT No.0</p> <p>Temperature</p> <p>Channel No.</p> <p>CONNECT No. * CH No. FE0CBA9876543210 WDT Error Data Format 0110110110110110 Conversion 0110110110110110 Error Enable 0: Disabled 1: Enabled Temp. Value Err</p> <p>1) 2) 3) 4)</p>	1)	---	---																																																																																																																																																
	2)	512 to 639	0200 to 027F																																																																																																																																																
	3)	0	0000																																																																																																																																																
	4)	16 to 23	0010 to 0017																																																																																																																																																
<p>A616TD Graph Monitor Screen INPUT 0-F</p> <p>Input Status [%] 0/0 50 100/50 100</p> <p>Channel No.</p> <p>Scale A (0): Data Format 0 Scale B (0): Data Format 1</p> <p>1) 2) 3) 4)</p>	1)	16 to 23	0070 to 007F																																																																																																																																																
	2)	---	---																																																																																																																																																
	3)	0	0000																																																																																																																																																
	4)	15	000F																																																																																																																																																

Screen Image	No.	Buffer memory address	
		dec.	hex.
<p>1) A616TD Graph Monitor Screen CONNECT No.0</p> <p>2) Input Status [%] 0/0 50 100/50 100</p> <p>3) Temperature Value [C]</p> <p>4) WDT Error, Error, Digital Val. Err, Temp. Val. Err</p> <p>5) Data Format 0110110110110110 * Channel No. FEDCBA9876543210 0: Scale A (0) 1: Scale B (0) Conversion 0110110110110110 Enable 0: Disabled 1: Enabled</p>	1)	---	---
	2)	384 to 511	0180 to 01FF
	3)	512 to 639	0200 to 027F
	4)	---	---
	5)	0	0000
		16 to 23	0010 to 0017

12.19 AD70,A1SD70 Module Monitor

Screen Image		No.	Buffer memory address	
			dec.	hex.
		1)	---	---
		2)	100, 101	0064, 0065
		3)	102, 103	0066, 0067
		4)	106, 107	006A, 006B
		5)	61, 62	003D, 003E
		6)	65, 66	0041, 0042
		7)	63, 64	003F, 0040
		8)	67, 68	0043, 0044
		9)	60	003C
		10)	111	006F
		11)	104	0068
		12)	105	0069
		13)	80, 81	0050, 0051
		14)	88, 89	0058, 0059
		15)	82, 83	0052, 0053
		16)	84, 85	0054, 0055
		17)	0, 1	0000, 0001
		18)	2, 3	0002, 0003
		19)	4, 5	0004, 0005
		20)	20, 21	0014, 0015
		21)	22	0016
		22)	23	0017
		23)	24	0018
		24)	25	0019
		1)	---	---
		2)	100, 101	0064, 0065
		3)	102, 103	0066, 0067
		4)	106, 107	006A, 006B
		5)	61, 62	003D, 003E
		6)	65, 66	0041, 0042
		7)	63, 64	003F, 0040
		8)	67, 68	0043, 0044
		9)	60	003C
		10)	111	006F
		11)	104	0068
		12)	105	0069
		13)	80, 81	0050, 0051
		14)	88, 89	0058, 0059
		15)	82, 83	0052, 0053
		16)	84, 85	0054, 0055
		17)	108, 109	006C, 006D
		18)	46, 47	002E, 002F
		19)	40, 41	0028, 0029
		20)	42, 43	002A, 002B
		21)	44, 45	002C, 002D

Screen Image	No.	Buffer memory address																																																																																																													
		dec.	hex.																																																																																																												
<div style="border: 1px solid black; padding: 10px;"> <p style="text-align: center;">AD70 Input/Output Monitor Screen</p> <table style="width: 100%; border-collapse: collapse;"> <tr> <td style="width: 25%;"></td> <td style="width: 10%; text-align: center;">SET/ RESET</td> <td style="width: 10%; text-align: center;">Data Chg.</td> <td style="width: 10%; text-align: center;">MONIT MENU</td> <td style="width: 10%; text-align: center;">END</td> <td style="width: 25%;"></td> </tr> <tr> <td colspan="3" style="text-align: center;">Inputs (X)</td> <td colspan="3" style="text-align: center;">Outputs (Y)</td> </tr> <tr> <td>00</td><td>MDT Error</td><td>10</td> <td>00</td><td>Zero Rtn Start</td><td>10</td> </tr> <tr> <td>01</td><td>AD70 READY</td><td>11</td> <td>01</td><td>Posit. Start</td><td>11</td> </tr> <tr> <td>02</td><td>Zero Rtn Request</td><td>12</td> <td>02</td><td>Forward Start</td><td>12</td> </tr> <tr> <td>03</td><td>Zero Rtn Comple.</td><td>13</td> <td>03</td><td>Reverse Start</td><td>13</td> </tr> <tr> <td>04</td><td>BUSY</td><td>14</td> <td>04</td><td>Fwd. Jog Start</td><td>14</td> </tr> <tr> <td>05</td><td>Posit. Complete</td><td>15</td> <td>05</td><td>Rev. Jog Start</td><td>15</td> </tr> <tr> <td>06</td><td>In-position</td><td>16</td> <td>06</td><td>Vel/Pos Restart</td><td>16</td> </tr> <tr> <td>07</td><td>Excessive Error</td><td>17</td> <td>07</td><td>Stop</td><td>17</td> </tr> <tr> <td>08</td><td>Error Detection</td><td>18</td> <td>08</td><td>Error Reset</td><td>18</td> </tr> <tr> <td>09</td><td>Overflow</td><td>19</td> <td>09</td><td>Overflow Reset</td><td>19</td> </tr> <tr> <td>0A</td><td>Underflow</td><td>1A</td> <td>0A</td><td>Underflow Reset</td><td>1A</td> </tr> <tr> <td>0B</td><td>Servo Ready</td><td>1B</td> <td>0B</td><td></td><td>1B</td> </tr> <tr> <td>0C</td><td>Near Zero Point</td><td>1C</td> <td>0C</td><td>V/P Switchover</td><td>1C</td> </tr> <tr> <td>0D</td><td>Stop (External)</td><td>1D</td> <td>0D</td><td>PLC READY</td><td>1D</td> </tr> <tr> <td>0E</td><td>Upper Limit LS</td><td>1E</td> <td>0E</td><td></td><td>1E</td> </tr> <tr> <td>0F</td><td>Lower Limit LS</td><td>1F</td> <td>0F</td><td></td><td>1F</td> </tr> </table> </div>		SET/ RESET	Data Chg.	MONIT MENU	END		Inputs (X)			Outputs (Y)			00	MDT Error	10	00	Zero Rtn Start	10	01	AD70 READY	11	01	Posit. Start	11	02	Zero Rtn Request	12	02	Forward Start	12	03	Zero Rtn Comple.	13	03	Reverse Start	13	04	BUSY	14	04	Fwd. Jog Start	14	05	Posit. Complete	15	05	Rev. Jog Start	15	06	In-position	16	06	Vel/Pos Restart	16	07	Excessive Error	17	07	Stop	17	08	Error Detection	18	08	Error Reset	18	09	Overflow	19	09	Overflow Reset	19	0A	Underflow	1A	0A	Underflow Reset	1A	0B	Servo Ready	1B	0B		1B	0C	Near Zero Point	1C	0C	V/P Switchover	1C	0D	Stop (External)	1D	0D	PLC READY	1D	0E	Upper Limit LS	1E	0E		1E	0F	Lower Limit LS	1F	0F		1F	1)	—	—
		SET/ RESET	Data Chg.	MONIT MENU	END																																																																																																										
Inputs (X)			Outputs (Y)																																																																																																												
00	MDT Error	10	00	Zero Rtn Start	10																																																																																																										
01	AD70 READY	11	01	Posit. Start	11																																																																																																										
02	Zero Rtn Request	12	02	Forward Start	12																																																																																																										
03	Zero Rtn Comple.	13	03	Reverse Start	13																																																																																																										
04	BUSY	14	04	Fwd. Jog Start	14																																																																																																										
05	Posit. Complete	15	05	Rev. Jog Start	15																																																																																																										
06	In-position	16	06	Vel/Pos Restart	16																																																																																																										
07	Excessive Error	17	07	Stop	17																																																																																																										
08	Error Detection	18	08	Error Reset	18																																																																																																										
09	Overflow	19	09	Overflow Reset	19																																																																																																										
0A	Underflow	1A	0A	Underflow Reset	1A																																																																																																										
0B	Servo Ready	1B	0B		1B																																																																																																										
0C	Near Zero Point	1C	0C	V/P Switchover	1C																																																																																																										
0D	Stop (External)	1D	0D	PLC READY	1D																																																																																																										
0E	Upper Limit LS	1E	0E		1E																																																																																																										
0F	Lower Limit LS	1F	0F		1F																																																																																																										

12.20 AD70D Module Monitor

Screen Image		No.	Buffer memory address	
			dec.	hex.
		1)	---	---
		2)	100, 101	0064, 0065
		3)	102, 103	0066, 0067
		4)	104, 105	0068, 0069
		5)	61, 62	003D, 003E
		6)	65, 66	0041, 0042
		7)	63, 64	003F, 0040
		8)	67, 68	0043, 0044
		9)	60	003C
		10)	119	0077
		11)	120	0078
		12)	121	0079
		13)	122	007A
		14)	123	007B
		15)	80, 81	0050, 0051
		16)	86, 87	0056, 0057
		17)	82, 83	0052, 0053
		18)	84, 85	0054, 0055
		19)	89	0059
		20)	110	006E
		21)	111	006F
		22)	112	0070
		23)	113	0071
		24)	125	007D
		25)	126	007E
		1)	---	---
		2)	100, 101	0064, 0065
		3)	102, 103	0066, 0067
		4)	104, 105	0068, 0069
		5)	30, 31	001E, 001F
		6)	32, 33	0020, 0021
		7)	34, 35	0022, 0023
		8)	108, 109	006C, 006D
		9)	106, 107	006A, 006B
		10)	36, 37	0024, 0025
		11)	119	0077
		12)	120	0078
		13)	121	0079
		14)	122	007A
		15)	123	007B
		16)	80, 81	0050, 0051
		17)	86, 87	0056, 0057
		18)	82, 83	0052, 0053
		19)	84, 85	0054, 0055
		20)	89	0059
		21)	110	006E
		22)	111	006F
		23)	112	0070
		24)	113	0071
		25)	125	007D
		26)	126	007E

Screen Image		No.	Buffer memory address																																																																					
			dec.	hex.																																																																				
<p>AD70D Parameter Data Monitor Screen</p> <table border="1"> <tr> <td>Y11 Posit. Start</td> <td>Upper Limit 2) 01234567890</td> <td>In-position Range 012345 PLS</td> </tr> <tr> <td>Y12 Forward Start</td> <td>Lower Limit 3) 01234567890</td> <td>Feedback Pulses 012345 PLS</td> </tr> <tr> <td>Y13 Reverse Start</td> <td>Electronic Gear 4) 0123/ 0123</td> <td>Rotation Direction 0</td> </tr> <tr> <td>Y14 Fwd. Jog Start</td> <td>System Setting 5) 0</td> <td>Torque Limit 012345 %</td> </tr> <tr> <td>Y15 Rev. Jog Start</td> <td>Regen. Resistance 6) 0</td> <td>Velocity Limit 0123456 PLS/s</td> </tr> <tr> <td>Y16 Vel./Pos Restart</td> <td>Motor Type 7) 0</td> <td>Accel. Time 012345 ms</td> </tr> <tr> <td>X05 Posit. Complete</td> <td>Motor Capacity 0123.5 kW</td> <td>Decel. Time 012345 ms</td> </tr> <tr> <td>Zero Rtn Request</td> <td>Motor Rotations 012345 rpm</td> <td>Positioning Mode 0</td> </tr> <tr> <td>Y10 Zero Rtn Start</td> <td>Pos. Loop Gain 012345 rad/s</td> <td>Amplifier Ver. A01W012-ABC</td> </tr> <tr> <td>X03 Zero Rtn Comple.</td> <td>Vel. Loop Gain 012345</td> <td>Test Mode 0110110110110110-87654321</td> </tr> <tr> <td>Y17 Stop</td> <td>Vel. Integration 012345 ms</td> <td>S/Switch 0110110110110110</td> </tr> <tr> <td>X04 BUSY</td> <td></td> <td></td> </tr> <tr> <td>In-position</td> <td></td> <td></td> </tr> <tr> <td>Y18 Servo OFF</td> <td></td> <td></td> </tr> <tr> <td>Y14 V/P Switchover</td> <td></td> <td></td> </tr> <tr> <td>X00 WDT Error</td> <td></td> <td></td> </tr> <tr> <td>X08 Error Detection</td> <td></td> <td></td> </tr> </table>		Y11 Posit. Start	Upper Limit 2) 01234567890	In-position Range 012345 PLS	Y12 Forward Start	Lower Limit 3) 01234567890	Feedback Pulses 012345 PLS	Y13 Reverse Start	Electronic Gear 4) 0123/ 0123	Rotation Direction 0	Y14 Fwd. Jog Start	System Setting 5) 0	Torque Limit 012345 %	Y15 Rev. Jog Start	Regen. Resistance 6) 0	Velocity Limit 0123456 PLS/s	Y16 Vel./Pos Restart	Motor Type 7) 0	Accel. Time 012345 ms	X05 Posit. Complete	Motor Capacity 0123.5 kW	Decel. Time 012345 ms	Zero Rtn Request	Motor Rotations 012345 rpm	Positioning Mode 0	Y10 Zero Rtn Start	Pos. Loop Gain 012345 rad/s	Amplifier Ver. A01W012-ABC	X03 Zero Rtn Comple.	Vel. Loop Gain 012345	Test Mode 0110110110110110-87654321	Y17 Stop	Vel. Integration 012345 ms	S/Switch 0110110110110110	X04 BUSY			In-position			Y18 Servo OFF			Y14 V/P Switchover			X00 WDT Error			X08 Error Detection			1)	---	---																	
		Y11 Posit. Start	Upper Limit 2) 01234567890	In-position Range 012345 PLS																																																																				
		Y12 Forward Start	Lower Limit 3) 01234567890	Feedback Pulses 012345 PLS																																																																				
		Y13 Reverse Start	Electronic Gear 4) 0123/ 0123	Rotation Direction 0																																																																				
		Y14 Fwd. Jog Start	System Setting 5) 0	Torque Limit 012345 %																																																																				
		Y15 Rev. Jog Start	Regen. Resistance 6) 0	Velocity Limit 0123456 PLS/s																																																																				
		Y16 Vel./Pos Restart	Motor Type 7) 0	Accel. Time 012345 ms																																																																				
		X05 Posit. Complete	Motor Capacity 0123.5 kW	Decel. Time 012345 ms																																																																				
		Zero Rtn Request	Motor Rotations 012345 rpm	Positioning Mode 0																																																																				
		Y10 Zero Rtn Start	Pos. Loop Gain 012345 rad/s	Amplifier Ver. A01W012-ABC																																																																				
		X03 Zero Rtn Comple.	Vel. Loop Gain 012345	Test Mode 0110110110110110-87654321																																																																				
		Y17 Stop	Vel. Integration 012345 ms	S/Switch 0110110110110110																																																																				
		X04 BUSY																																																																						
		In-position																																																																						
		Y18 Servo OFF																																																																						
		Y14 V/P Switchover																																																																						
		X00 WDT Error																																																																						
		X08 Error Detection																																																																						
			2)	0, 1	0000, 0001																																																																			
			3)	2, 3	0002, 0003																																																																			
			4)	4, 5	0004, 0005																																																																			
			5)	10	000A																																																																			
			6)	11	000B																																																																			
	7)	12	000C																																																																					
	8)	13	000D																																																																					
	9)	14	000E																																																																					
	10)	15	000F																																																																					
	11)	16	0010																																																																					
	12)	17	0011																																																																					
	13)	18	0012																																																																					
	14)	19	0013																																																																					
	15)	20	0014																																																																					
	16)	21	0015																																																																					
	17)	40, 41	0028, 0029																																																																					
	18)	42	002A																																																																					
	19)	43	002B																																																																					
	20)	44	002C																																																																					
	21)	114 to 117	0072 to 0075																																																																					
	22)	125	007D																																																																					
	23)	126	007E																																																																					
<p>AD70D Input/Output Monitor Screen</p> <table border="1"> <thead> <tr> <th colspan="2">Inputs (X)</th> <th colspan="2">Outputs (Y)</th> </tr> </thead> <tbody> <tr><td>00</td><td>WDT Error</td><td>10</td><td>Zero Rtn Start</td></tr> <tr><td>01</td><td>READY</td><td>11</td><td>Posit. Start</td></tr> <tr><td>02</td><td>Zero Rtn Request</td><td>12</td><td>Forward Start</td></tr> <tr><td>03</td><td>Zero Rtn Comple.</td><td>13</td><td>Reverse Start</td></tr> <tr><td>04</td><td>BUSY</td><td>14</td><td>Fwd. Jog Start</td></tr> <tr><td>05</td><td>Posit. Complete</td><td>15</td><td>Rev. Jog Start</td></tr> <tr><td>06</td><td>In-position</td><td>16</td><td>Vel./Pos Restart</td></tr> <tr><td>07</td><td>Zero Return</td><td>17</td><td>Stop</td></tr> <tr><td>08</td><td>Error Detection</td><td>18</td><td>Error Reset</td></tr> <tr><td>09</td><td>Overflow</td><td>19</td><td>Overflow Reset</td></tr> <tr><td>0A</td><td>Underflow</td><td>1A</td><td>Underflow Reset</td></tr> <tr><td>0B</td><td>Servo Ready</td><td>1B</td><td>Servo OFF</td></tr> <tr><td>0C</td><td>Near Zero Point</td><td>1C</td><td>V/P Switchover</td></tr> <tr><td>0D</td><td>Stop (External)</td><td>1D</td><td>PLC READY</td></tr> <tr><td>0E</td><td>Upper Limit LS</td><td>1E</td><td></td></tr> <tr><td>0F</td><td>Lower Limit LS</td><td>1F</td><td></td></tr> </tbody> </table>		Inputs (X)		Outputs (Y)		00	WDT Error	10	Zero Rtn Start	01	READY	11	Posit. Start	02	Zero Rtn Request	12	Forward Start	03	Zero Rtn Comple.	13	Reverse Start	04	BUSY	14	Fwd. Jog Start	05	Posit. Complete	15	Rev. Jog Start	06	In-position	16	Vel./Pos Restart	07	Zero Return	17	Stop	08	Error Detection	18	Error Reset	09	Overflow	19	Overflow Reset	0A	Underflow	1A	Underflow Reset	0B	Servo Ready	1B	Servo OFF	0C	Near Zero Point	1C	V/P Switchover	0D	Stop (External)	1D	PLC READY	0E	Upper Limit LS	1E		0F	Lower Limit LS	1F		1)	---	---
		Inputs (X)		Outputs (Y)																																																																				
00	WDT Error	10	Zero Rtn Start																																																																					
01	READY	11	Posit. Start																																																																					
02	Zero Rtn Request	12	Forward Start																																																																					
03	Zero Rtn Comple.	13	Reverse Start																																																																					
04	BUSY	14	Fwd. Jog Start																																																																					
05	Posit. Complete	15	Rev. Jog Start																																																																					
06	In-position	16	Vel./Pos Restart																																																																					
07	Zero Return	17	Stop																																																																					
08	Error Detection	18	Error Reset																																																																					
09	Overflow	19	Overflow Reset																																																																					
0A	Underflow	1A	Underflow Reset																																																																					
0B	Servo Ready	1B	Servo OFF																																																																					
0C	Near Zero Point	1C	V/P Switchover																																																																					
0D	Stop (External)	1D	PLC READY																																																																					
0E	Upper Limit LS	1E																																																																						
0F	Lower Limit LS	1F																																																																						

12.21 AD71 Module Monitor

Screen Image		Buffer memory address				
		No.	X		Y	
			dec.	hex.	dec.	hex.
		1)	---	---	---	---
		2)	47	002F	347	015B
		3)	48	0030	348	015C
		4)	39	0027	339	0153
		5)	602	025A	604	025C
		6)	603	025B	605	025D
		7)	41	0029	341	0155
		8)	42	002A	342	0156
		9)	7912	1EE8	7922	1EF2
		10)	7913	1EE9	7923	1EF3
		11)	600	0258	601	0259
		12)	7874	1EC2	7894	1ED6
		13)	40	0028	340	0154
		14)	44	002C	344	0158
				1)	---	---
2)	47			002F	347	015B
3)	48			0030	348	015C
4)	39			0027	339	0153
5)	602			025A	604	025C
6)	603			025B	605	025D
7)	41			0029	341	0155
8)	42			002A	342	0156
9)	7912			1EE8	7922	1EF2
10)	7913			1EE9	7923	1EF3
11)	600			0258	601	0259
12)	7874			1EC2	7894	1ED6
13)	40			0028	340	0154
14)	7914			1EEA	7924	1EF4
15)	7915			1EEB	7925	1EF5
16)	46			002E	346	015A
17)	45			002D	345	0159
18)	7918	1EEE	7928	1EF8		
19)	7917	1EED	7927	1EF7		
20)	7916	1EEC	7926	1EF6		

Screen Image		No.	Buffer memory address			
			X		Y	
			dec.	hex.	dec.	hex.
		1)	---	---	---	---
		2)	47	002F	347	015B
		3)	7873	1EC1	7893	1ED5
		4)	7884	1ECC	7904	1EE0
			7885	1ECD	7905	1EE1
		5)	7874	1EC2	7894	1ED6
		6)	7875	1EC3	7895	1ED7
		7)	7876	1EC4	7896	1ED8
		8)	7877	1EC5	7897	1ED9
		9)	7878	1EC6	7898	1EDA
			7879	1EC7	7899	1EDB
		10)	7880	1EC8	7900	1EDC
		11)	7882	1ECA	7902	1EDE
			7883	1ECB	7903	1EDF
		12)	7886	1ECE	7906	1EE2
		13)	7887	1ECF	7907	1EE3
14)	46	002E	346	015A		
15)	45	002D	345	0159		
16)	7872	1EC0	7892	1ED4		
		1)	---	---	---	---
		2)	47	002F	347	015B
		3)	46	002E	346	015A
		4)	49	0031	349	015D
			to	to	to	to
		200	00C8	500	01F4	
		5)	48	0030	348	015C
		6)	39	0027	339	0153
7)	45	002D	345	0159		
8)	43	002B	343	0157		
			---	---	---	---

Screen Image	No.	Buffer memory address																																																																																																																																																																																																																																																															
		X		Y																																																																																																																																																																																																																																																													
		dec.	hex.	dec.	hex.																																																																																																																																																																																																																																																												
<p>AD71 Input/Output Monitor Screen</p> <table border="1"> <thead> <tr> <th colspan="4">Inputs (X)</th> <th colspan="4">Outputs (Y)</th> </tr> </thead> <tbody> <tr><td>00</td><td>WDT Error</td><td>10</td><td></td><td>00</td><td></td><td>10</td><td>X Posit. Start</td></tr> <tr><td>01</td><td>READY</td><td>11</td><td></td><td>01</td><td></td><td>11</td><td>Y Posit. Start</td></tr> <tr><td>02</td><td>X Posit. Complete</td><td>12</td><td></td><td>02</td><td></td><td>12</td><td>Interpolation</td></tr> <tr><td>03</td><td>Y Posit. Complete</td><td>13</td><td></td><td>03</td><td></td><td>13</td><td>X Zeroing Start</td></tr> <tr><td>04</td><td>X Axis BUSY</td><td>14</td><td></td><td>04</td><td></td><td>14</td><td>Y Zeroing Start</td></tr> <tr><td>05</td><td>Y Axis BUSY</td><td>15</td><td></td><td>05</td><td></td><td>15</td><td>X Stop</td></tr> <tr><td>06</td><td>X Zero Request</td><td>16</td><td></td><td>06</td><td></td><td>16</td><td>Y Stop</td></tr> <tr><td>07</td><td>Y Zero Request</td><td>17</td><td></td><td>07</td><td></td><td>17</td><td>X Fwd. Jog Start</td></tr> <tr><td>08</td><td>X Posit. Started</td><td>18</td><td></td><td>08</td><td></td><td>18</td><td>X Rev. Jog Start</td></tr> <tr><td>09</td><td>Y Posit. Started</td><td>19</td><td></td><td>09</td><td></td><td>19</td><td>Y Fwd. Jog Start</td></tr> <tr><td>0A</td><td>Battery Error</td><td>1A</td><td></td><td>0A</td><td></td><td>1A</td><td>Y Rev. Jog Start</td></tr> <tr><td>0B</td><td>Error Detection</td><td>1B</td><td></td><td>0B</td><td></td><td>1B</td><td>X M Code OFF</td></tr> <tr><td>0C</td><td>X Zero Complete</td><td>1C</td><td></td><td>0C</td><td></td><td>1C</td><td>Y M Code OFF</td></tr> <tr><td>0D</td><td>Y Zero Complete</td><td>1D</td><td></td><td>0D</td><td></td><td>1D</td><td>PLC READY</td></tr> <tr><td>0E</td><td>X M Code DN</td><td>1E</td><td></td><td>0E</td><td></td><td>1E</td><td></td></tr> <tr><td>0F</td><td>Y M Code DN</td><td>1F</td><td></td><td>0F</td><td></td><td>1F</td><td></td></tr> </tbody> </table> <p>1) →</p>	Inputs (X)				Outputs (Y)				00	WDT Error	10		00		10	X Posit. Start	01	READY	11		01		11	Y Posit. Start	02	X Posit. Complete	12		02		12	Interpolation	03	Y Posit. Complete	13		03		13	X Zeroing Start	04	X Axis BUSY	14		04		14	Y Zeroing Start	05	Y Axis BUSY	15		05		15	X Stop	06	X Zero Request	16		06		16	Y Stop	07	Y Zero Request	17		07		17	X Fwd. Jog Start	08	X Posit. Started	18		08		18	X Rev. Jog Start	09	Y Posit. Started	19		09		19	Y Fwd. Jog Start	0A	Battery Error	1A		0A		1A	Y Rev. Jog Start	0B	Error Detection	1B		0B		1B	X M Code OFF	0C	X Zero Complete	1C		0C		1C	Y M Code OFF	0D	Y Zero Complete	1D		0D		1D	PLC READY	0E	X M Code DN	1E		0E		1E		0F	Y M Code DN	1F		0F		1F		1)	---	---	---	---																																																																																																																				
Inputs (X)				Outputs (Y)																																																																																																																																																																																																																																																													
00	WDT Error	10		00		10	X Posit. Start																																																																																																																																																																																																																																																										
01	READY	11		01		11	Y Posit. Start																																																																																																																																																																																																																																																										
02	X Posit. Complete	12		02		12	Interpolation																																																																																																																																																																																																																																																										
03	Y Posit. Complete	13		03		13	X Zeroing Start																																																																																																																																																																																																																																																										
04	X Axis BUSY	14		04		14	Y Zeroing Start																																																																																																																																																																																																																																																										
05	Y Axis BUSY	15		05		15	X Stop																																																																																																																																																																																																																																																										
06	X Zero Request	16		06		16	Y Stop																																																																																																																																																																																																																																																										
07	Y Zero Request	17		07		17	X Fwd. Jog Start																																																																																																																																																																																																																																																										
08	X Posit. Started	18		08		18	X Rev. Jog Start																																																																																																																																																																																																																																																										
09	Y Posit. Started	19		09		19	Y Fwd. Jog Start																																																																																																																																																																																																																																																										
0A	Battery Error	1A		0A		1A	Y Rev. Jog Start																																																																																																																																																																																																																																																										
0B	Error Detection	1B		0B		1B	X M Code OFF																																																																																																																																																																																																																																																										
0C	X Zero Complete	1C		0C		1C	Y M Code OFF																																																																																																																																																																																																																																																										
0D	Y Zero Complete	1D		0D		1D	PLC READY																																																																																																																																																																																																																																																										
0E	X M Code DN	1E		0E		1E																																																																																																																																																																																																																																																											
0F	Y M Code DN	1F		0F		1F																																																																																																																																																																																																																																																											
<p>AD71 Positioning Data Monitor Screen</p> <table border="1"> <thead> <tr> <th>Address</th> <th>Speed</th> <th>Dwell</th> <th>M</th> <th>Code</th> <th>*</th> <th>Address</th> <th>Speed</th> <th>Dwell</th> <th>M</th> <th>Code</th> <th>*</th> </tr> </thead> <tbody> <tr><td>001</td><td>01234567</td><td>01234</td><td>012</td><td>012</td><td>0</td><td>001</td><td>01234567</td><td>01234</td><td>012</td><td>012</td><td>0</td></tr> <tr><td>002</td><td>01234567</td><td>01234</td><td>012</td><td>012</td><td>0</td><td>002</td><td>01234567</td><td>01234</td><td>012</td><td>012</td><td>0</td></tr> <tr><td>003</td><td>01234567</td><td>01234</td><td>012</td><td>012</td><td>0</td><td>003</td><td>01234567</td><td>01234</td><td>012</td><td>012</td><td>0</td></tr> <tr><td>004</td><td>01234567</td><td>01234</td><td>012</td><td>012</td><td>0</td><td>004</td><td>01234567</td><td>01234</td><td>012</td><td>012</td><td>0</td></tr> <tr><td>005</td><td>01234567</td><td>01234</td><td>012</td><td>012</td><td>0</td><td>005</td><td>01234567</td><td>01234</td><td>012</td><td>012</td><td>0</td></tr> <tr><td>006</td><td>01234567</td><td>01234</td><td>012</td><td>012</td><td>0</td><td>006</td><td>01234567</td><td>01234</td><td>012</td><td>012</td><td>0</td></tr> <tr><td>007</td><td>01234567</td><td>01234</td><td>012</td><td>012</td><td>0</td><td>007</td><td>01234567</td><td>01234</td><td>012</td><td>012</td><td>0</td></tr> <tr><td>008</td><td>01234567</td><td>01234</td><td>012</td><td>012</td><td>0</td><td>008</td><td>01234567</td><td>01234</td><td>012</td><td>012</td><td>0</td></tr> <tr><td>009</td><td>01234567</td><td>01234</td><td>012</td><td>012</td><td>0</td><td>009</td><td>01234567</td><td>01234</td><td>012</td><td>012</td><td>0</td></tr> <tr><td>010</td><td>01234567</td><td>01234</td><td>012</td><td>012</td><td>0</td><td>010</td><td>01234567</td><td>01234</td><td>012</td><td>012</td><td>0</td></tr> <tr><td>011</td><td>01234567</td><td>01234</td><td>012</td><td>012</td><td>0</td><td>011</td><td>01234567</td><td>01234</td><td>012</td><td>012</td><td>0</td></tr> <tr><td>012</td><td>01234567</td><td>01234</td><td>012</td><td>012</td><td>0</td><td>012</td><td>01234567</td><td>01234</td><td>012</td><td>012</td><td>0</td></tr> <tr><td>013</td><td>01234567</td><td>01234</td><td>012</td><td>012</td><td>0</td><td>013</td><td>01234567</td><td>01234</td><td>012</td><td>012</td><td>0</td></tr> <tr><td>014</td><td>01234567</td><td>01234</td><td>012</td><td>012</td><td>0</td><td>014</td><td>01234567</td><td>01234</td><td>012</td><td>012</td><td>0</td></tr> <tr><td>015</td><td>01234567</td><td>01234</td><td>012</td><td>012</td><td>0</td><td>015</td><td>01234567</td><td>01234</td><td>012</td><td>012</td><td>0</td></tr> <tr><td>016</td><td>01234567</td><td>01234</td><td>012</td><td>012</td><td>0</td><td>016</td><td>01234567</td><td>01234</td><td>012</td><td>012</td><td>0</td></tr> <tr><td>017</td><td>01234567</td><td>01234</td><td>012</td><td>012</td><td>0</td><td>017</td><td>01234567</td><td>01234</td><td>012</td><td>012</td><td>0</td></tr> <tr><td>018</td><td>01234567</td><td>01234</td><td>012</td><td>012</td><td>0</td><td>018</td><td>01234567</td><td>01234</td><td>012</td><td>012</td><td>0</td></tr> <tr><td>019</td><td>01234567</td><td>01234</td><td>012</td><td>012</td><td>0</td><td>019</td><td>01234567</td><td>01234</td><td>012</td><td>012</td><td>0</td></tr> <tr><td>020</td><td>01234567</td><td>01234</td><td>012</td><td>012</td><td>0</td><td>020</td><td>01234567</td><td>01234</td><td>012</td><td>012</td><td>0</td></tr> </tbody> </table> <p>1) 2) 3) 4) 5)</p>	Address	Speed	Dwell	M	Code	*	Address	Speed	Dwell	M	Code	*	001	01234567	01234	012	012	0	001	01234567	01234	012	012	0	002	01234567	01234	012	012	0	002	01234567	01234	012	012	0	003	01234567	01234	012	012	0	003	01234567	01234	012	012	0	004	01234567	01234	012	012	0	004	01234567	01234	012	012	0	005	01234567	01234	012	012	0	005	01234567	01234	012	012	0	006	01234567	01234	012	012	0	006	01234567	01234	012	012	0	007	01234567	01234	012	012	0	007	01234567	01234	012	012	0	008	01234567	01234	012	012	0	008	01234567	01234	012	012	0	009	01234567	01234	012	012	0	009	01234567	01234	012	012	0	010	01234567	01234	012	012	0	010	01234567	01234	012	012	0	011	01234567	01234	012	012	0	011	01234567	01234	012	012	0	012	01234567	01234	012	012	0	012	01234567	01234	012	012	0	013	01234567	01234	012	012	0	013	01234567	01234	012	012	0	014	01234567	01234	012	012	0	014	01234567	01234	012	012	0	015	01234567	01234	012	012	0	015	01234567	01234	012	012	0	016	01234567	01234	012	012	0	016	01234567	01234	012	012	0	017	01234567	01234	012	012	0	017	01234567	01234	012	012	0	018	01234567	01234	012	012	0	018	01234567	01234	012	012	0	019	01234567	01234	012	012	0	019	01234567	01234	012	012	0	020	01234567	01234	012	012	0	020	01234567	01234	012	012	0	1)	5072 to 5111	13D0 to 13F7	7072 to 7111	1BA0 to 1BC7
Address	Speed	Dwell	M	Code	*	Address	Speed	Dwell	M	Code	*																																																																																																																																																																																																																																																						
001	01234567	01234	012	012	0	001	01234567	01234	012	012	0																																																																																																																																																																																																																																																						
002	01234567	01234	012	012	0	002	01234567	01234	012	012	0																																																																																																																																																																																																																																																						
003	01234567	01234	012	012	0	003	01234567	01234	012	012	0																																																																																																																																																																																																																																																						
004	01234567	01234	012	012	0	004	01234567	01234	012	012	0																																																																																																																																																																																																																																																						
005	01234567	01234	012	012	0	005	01234567	01234	012	012	0																																																																																																																																																																																																																																																						
006	01234567	01234	012	012	0	006	01234567	01234	012	012	0																																																																																																																																																																																																																																																						
007	01234567	01234	012	012	0	007	01234567	01234	012	012	0																																																																																																																																																																																																																																																						
008	01234567	01234	012	012	0	008	01234567	01234	012	012	0																																																																																																																																																																																																																																																						
009	01234567	01234	012	012	0	009	01234567	01234	012	012	0																																																																																																																																																																																																																																																						
010	01234567	01234	012	012	0	010	01234567	01234	012	012	0																																																																																																																																																																																																																																																						
011	01234567	01234	012	012	0	011	01234567	01234	012	012	0																																																																																																																																																																																																																																																						
012	01234567	01234	012	012	0	012	01234567	01234	012	012	0																																																																																																																																																																																																																																																						
013	01234567	01234	012	012	0	013	01234567	01234	012	012	0																																																																																																																																																																																																																																																						
014	01234567	01234	012	012	0	014	01234567	01234	012	012	0																																																																																																																																																																																																																																																						
015	01234567	01234	012	012	0	015	01234567	01234	012	012	0																																																																																																																																																																																																																																																						
016	01234567	01234	012	012	0	016	01234567	01234	012	012	0																																																																																																																																																																																																																																																						
017	01234567	01234	012	012	0	017	01234567	01234	012	012	0																																																																																																																																																																																																																																																						
018	01234567	01234	012	012	0	018	01234567	01234	012	012	0																																																																																																																																																																																																																																																						
019	01234567	01234	012	012	0	019	01234567	01234	012	012	0																																																																																																																																																																																																																																																						
020	01234567	01234	012	012	0	020	01234567	01234	012	012	0																																																																																																																																																																																																																																																						
	2)	4272 to 4291	10B0 to 10C3	6272 to 6291	1880 to 1893																																																																																																																																																																																																																																																												
	3)	4672 to 4691	1240 to 1253	6672 to 6691	1A10 to 1A23																																																																																																																																																																																																																																																												
	4)	3872 to 3891	0F20 to 0F33	5872 to 5891	16F0 to 1703																																																																																																																																																																																																																																																												
	5)	3872 to 3891	0F20 to 0F33	5872 to 5891	16F0 to 1703																																																																																																																																																																																																																																																												
	—	---	---	---	---																																																																																																																																																																																																																																																												

12.22 AD72,A1SD71 Module Monitor

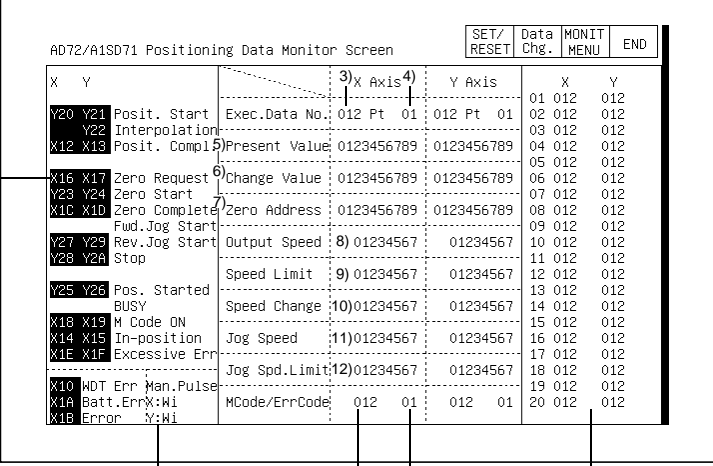
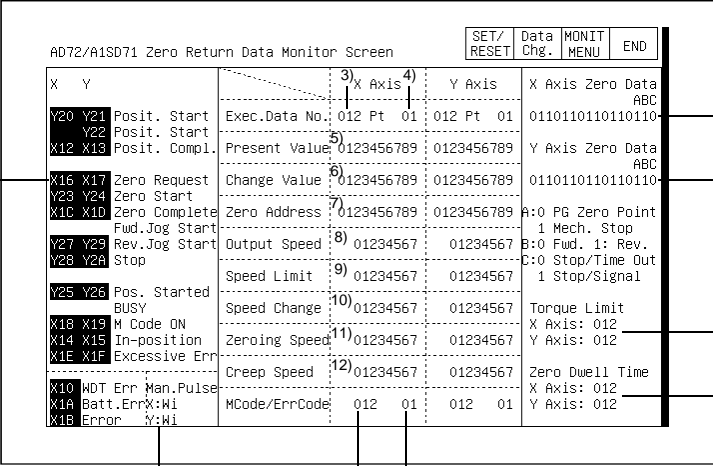
Screen Image		Buffer memory address				
		No.	X		Y	
			dec.	hex.	dec.	hex.
 <p>AD72/A1SD71 Positioning Data Monitor Screen</p> <p>SET/RESET Data Chg. MONIT MENU END</p> <p>X Y</p> <p>Y20 Y21 Posit. Start Exec.Data No. 012 Pt 01 012 Pt 01 01 012 012</p> <p>Y22 Interpolation 03 012 012</p> <p>X12 X13 Posit. Compl. Present Value 0123456789 0123456789 04 012 012</p> <p>X16 X17 Zero Request Change Value 0123456789 0123456789 05 012 012</p> <p>Y23 Y24 Zero Start 07 012 012</p> <p>X1C X1D Zero Complete Zero Address 0123456789 0123456789 08 012 012</p> <p>Y27 Y29 Rev.Jog Start Output Speed 01234567 01234567 10 012 012</p> <p>Y28 Y2A Stop 09 012 012</p> <p>Y25 Y26 Pos. Started Speed Limit 01234567 01234567 12 012 012</p> <p>BUSY 11 012 012</p> <p>X18 X19 M Code ON Speed Change 01234567 01234567 14 012 012</p> <p>X14 X15 In-position Jog Speed 01234567 01234567 15 012 012</p> <p>X1E X1F Excessive Err. Jog Spd. Limit 01234567 01234567 16 012 012</p> <p>X10 MDT Err Man.Pulse Creep Speed 01234567 01234567 18 012 012</p> <p>X1A Batt.ErrX:W1 MCode/ErrCode 012 01 012 01 19 012 012</p> <p>X1B Error Y:W1 20 012 012</p>		1)	---	---	---	---
2)	47	002F	347	015B		
3)	48	0030	348	015C		
4)	39	0027	339	0153		
5)	602	025A	604	025C		
6)	603	025B	605	025D		
7)	41	0029	341	0155		
8)	42	002A	342	0156		
9)	7912	1EE8	7922	1EF2		
10)	7913	1EE9	7923	1EF3		
11)	600	0258	601	0259		
12)	7874	1EC2	7894	1ED6		
13)	40	0028	340	0154		
14)	44	002C	344	0158		
15)	7875	1EC3	7895	1ED7		
16)	46	002E	346	015A		
17)	45	002D	345	0159		
18)	0	0000	300	012C		
19)	to	to	to	to		
20)	37	0025	337	0151		
 <p>AD72/A1SD71 Zero Return Data Monitor Screen</p> <p>SET/RESET Data Chg. MONIT MENU END</p> <p>X Y</p> <p>Y20 Y21 Posit. Start Exec.Data No. 012 Pt 01 012 Pt 01 0110110110110110</p> <p>Y22 Posit. Start 0110110110110110</p> <p>X12 X13 Posit. Compl. Present Value 0123456789 0123456789 Y Axis Zero Data ABC</p> <p>X16 X17 Zero Request Change Value 0123456789 0123456789 0110110110110110</p> <p>Y23 Y24 Zero Start 0123456789 0123456789 A:0 PG Zero Point</p> <p>X1C X1D Zero Complete Zero Address 0123456789 0123456789 1 Mech. Stop</p> <p>Y27 Y29 Rev.Jog Start Output Speed 01234567 01234567 B:0 Fwd. 1: Rev.</p> <p>Y28 Y2A Stop 01234567 01234567 C:0 Stop/Time Out</p> <p>Y25 Y26 Pos. Started Speed Limit 01234567 01234567 1 Stop/Signal</p> <p>BUSY 01234567 01234567 Torque Limit</p> <p>X18 X19 M Code ON Speed Change 01234567 01234567 X Axis: 012</p> <p>X14 X15 In-position Zeroing Speed 01234567 01234567 Y Axis: 012</p> <p>X1E X1F Excessive Err. Creep Speed 01234567 01234567 Zero Dwell Time</p> <p>X10 MDT Err Man.Pulse MCode/ErrCode 012 01 012 01 X Axis: 012</p> <p>X1A Batt.ErrX:W1 Y Axis: 012</p> <p>X1B Error Y:W1</p>		1)	---	---	---	---
2)	47	002F	347	015B		
3)	48	0030	348	015C		
4)	39	0027	339	0153		
5)	602	025A	604	025C		
6)	603	025B	605	025D		
7)	41	0029	341	0155		
8)	42	002A	342	0156		
9)	7912	1EE8	7922	1EF2		
10)	7913	1EE9	7923	1EF3		
11)	600	0258	601	0259		
12)	7874	1EC2	7894	1ED6		
13)	40	0028	340	0154		
14)	7914	1EEA	7924	1EF4		
15)	7915	1EEB	7925	1EF5		
16)	46	002E	346	015A		
17)	45	002D	345	0159		
18)	7918	1EEE	7928	1EF8		
19)	7917	1EED	7927	1EF7		
20)	7916	1EEC	7926	1EF6		

Screen Image		No.	Buffer memory address			
			X		Y	
			dec.	hex.	dec.	hex.
1)		1)	---	---	---	---
2)		2)	47	002F	347	015B
3)		3)	7873	1EC1	7893	1ED5
4)		4)	7884	1ECC	7904	1EE0
5)		5)	7885	1ECD	7905	1EE1
6)		6)	7874	1EC2	7894	1ED6
7)		7)	7875	1EC3	7895	1ED7
8)		8)	7876	1EC4	7896	1ED8
9)		9)	7877	1EC5	7897	1ED9
10)		10)	7878	1EC6	7898	1EDA
11)		11)	7879	1EC7	7899	1EDB
12)		12)	7880	1EC8	7900	1EDC
13)		13)	7881	1EC9	7901	1EDD
14)		14)	7882	1ECA	7902	1EDE
15)		15)	7883	1ECB	7903	1EDF
16)		16)	7886	1ECE	7906	1EE2
17)		17)	7887	1ECF	7907	1EE3
18)		18)	46	002E	346	015A
19)		19)	45	002D	345	0159
20)		20)	7872	1EC0	7892	1ED4
21)		21)	---	---	---	---
22)		22)	47	002F	347	015B
23)		23)	46	002E	346	015A
24)		24)	49	0031	349	015D
25)		25)	to	to	to	to
26)		26)	200	00C8	500	01F4
27)		27)	48	0030	348	015C
28)		28)	39	0027	339	0153
29)		29)	45	002D	345	0159
30)		30)	43	002B	343	0157
31)		31)	---	---	---	---

AD72/A1SD71 Parameter Data Monitor Screen

X	Y	Parameter	X Axis	Y Axis	X	Y
V20	V21	Posit. Start	Travel/Pulse	3) 01234567	01234567	0110110110110110
V22	V22	Posit. Start	Inching Trav.	4) 0123456789	0123456789	0110110110110110
X12	X13	Posit. Compl.				
X16	X17	Zero Request	Speed Limit	5) 01234567	01234567	A: Pulse O/P Mode
V23	V24	Zero Start	Jog Spd. Limit	6) 01234567	01234567	0 B Type
X1C	X1D	Zero Complete	Acc/Dec Time	7) 01234567	01234567	1 A Type
V27	V29	Rev. Jog Start	Backlash Comp.	8) 01234567	01234567	B: M Code Timing
V28	V2A	Stop				0 WITH Mode
V25	V26	Pos. Started	Upper Limit	01234567899)	0123456789	1 AFTER Mode
		BUSY	Lower Limit	012345678910)	0123456789	C: M Code ON/OFF
X18	X19	M Code ON	Error Comp.	11) 0123456789	0123456789	0 OFF 1 ON
X14	X15	In-position	Starting Bias	12) 01234567	01234567	DD: Posit. Method
X1E	X1F	Excessive Err	Compl. O/P Time	13) 01234567	01234567	00 ABS 01 INC
X10	WDT Err	Man. Pulse	Mcode/ErrCode	012	01	10 ABS + INC
X1A	Batt. Err	X:Hi				E: Direction
X1B	Error	Y:Hi				0 Fwd 1 Rev
						FF: Module Setting
						00 mm 01 inch
						10 deg 11 PLS

AD72/A1SD71 M Code Comment Monitor Screen

X	Y	Parameter	X Axis M Code: 012	Y Axis M Code: 012	X Axis	Y
V20	V21	Posit. Start	01	ABCDEFGHIJKLMN	Executing	
V22	V22	Interpolation	02	ABCDEFGHIJKLMN	Data No.:	012
X12	X13	Posit. Compl.	03	ABCDEFGHIJKLMN	Pointer:	012
X16	X17	Zero Return	04	ABCDEFGHIJKLMN	Error Code:	012
V23	V24	Zero Start	05	ABCDEFGHIJKLMN	Status:	012
X1C	X1D	Zero Complete	06	ABCDEFGHIJKLMN		
V27	V29	Rev. Jog Start	07	ABCDEFGHIJKLMN		
V28	V2A	Stop	08	ABCDEFGHIJKLMN		
V25	V26	Pos. Started	09	ABCDEFGHIJKLMN		
		BUSY	10	ABCDEFGHIJKLMN	Executing	
X18	X19	M Code ON	11	ABCDEFGHIJKLMN	Data No.:	012
X14	X15	In-position	12	ABCDEFGHIJKLMN	Pointer:	012
X1E	X1F	Excessive Err	13	ABCDEFGHIJKLMN	Error Code:	012
X10	WDT Err	Man. Pulse	14	ABCDEFGHIJKLMN	Status:	012
X1A	Batt. Err	X:Hi	15	ABCDEFGHIJKLMN		
X1B	Error	Y:Hi	16	ABCDEFGHIJKLMN		
			17	ABCDEFGHIJKLMN		
			18	ABCDEFGHIJKLMN		
			19	ABCDEFGHIJKLMN		

Screen Image	No.	Buffer memory address			
		X		Y	
		dec.	hex.	dec.	hex.
	1)	---	---	---	---
	1)	5072 to 5111	13D0 to 13F7	7072 to 7111	1BA0 to 1BC7
	2)	4272 to 4291	10B0 to 10C3	6272 to 6291	1880 to 1893
	3)	4672 to 4691	1240 to 1253	6672 to 6691	1A10 to 1A23
	4)	3872 to 3891	0F20 to 0F33	5872 to 5891	16F0 to 1703
	5)	3872 to 3891	0F20 to 0F33	5872 to 5891	16F0 to 1703
	---	---	---	---	---

12.23 AD75 A1SD75 Module Monitor

Screen Image	No.	Buffer memory address																																																																								
		1		2		3																																																																				
		dec.	hex.	dec.	hex.	dec.	hex.																																																																			
<p>AD75P I/O Monitor Screen</p> <table border="1"> <thead> <tr> <th colspan="2">X</th> <th colspan="2">Y</th> </tr> </thead> <tbody> <tr><td>00 AD75 Ready</td><td>10</td><td>00</td><td>10 Axis#1 Start</td></tr> <tr><td>01 Axis#1 Started</td><td>11</td><td>01</td><td>11 Axis#2 "</td></tr> <tr><td>02 Axis#2 "</td><td>12</td><td>02</td><td>12 Axis#3 "</td></tr> <tr><td>03 Axis#3 "</td><td>13</td><td>03</td><td>13 Axis#1 Stop</td></tr> <tr><td>04 Axis#1 BUSY</td><td>14</td><td>04</td><td>14 Axis#2 "</td></tr> <tr><td>05 Axis#2 "</td><td>15</td><td>05</td><td>15 Spar</td></tr> <tr><td>06 Axis#3 "</td><td>16</td><td>06</td><td>16 Axis#1 FWD JOG</td></tr> <tr><td>07 Axis#1 Completed</td><td>17</td><td>07</td><td>17 Axis#1 RVS "</td></tr> <tr><td>08 Axis#2 "</td><td>18</td><td>08</td><td>18 Axis#2 FWD "</td></tr> <tr><td>09 Axis#3 "</td><td>19</td><td>09</td><td>19 Axis#2 RVS "</td></tr> <tr><td>0A Axis#1 Error</td><td>1A</td><td>0A</td><td>1A Axis#3 FWD "</td></tr> <tr><td>0B Axis#2 "</td><td>1B</td><td>0B</td><td>1B Axis#3 RVS "</td></tr> <tr><td>0C Axis#3 "</td><td>1C</td><td>0C</td><td>1C Axis#3 Stop</td></tr> <tr><td>0D Axis#1 M Code</td><td>1D</td><td>0D</td><td>1D Ready</td></tr> <tr><td>0E Axis#2 "</td><td>1E</td><td>0E</td><td>1E Not for use</td></tr> <tr><td>0F Axis#3 "</td><td>1F</td><td>0F</td><td>1F Not for use</td></tr> </tbody> </table>	X		Y		00 AD75 Ready	10	00	10 Axis#1 Start	01 Axis#1 Started	11	01	11 Axis#2 "	02 Axis#2 "	12	02	12 Axis#3 "	03 Axis#3 "	13	03	13 Axis#1 Stop	04 Axis#1 BUSY	14	04	14 Axis#2 "	05 Axis#2 "	15	05	15 Spar	06 Axis#3 "	16	06	16 Axis#1 FWD JOG	07 Axis#1 Completed	17	07	17 Axis#1 RVS "	08 Axis#2 "	18	08	18 Axis#2 FWD "	09 Axis#3 "	19	09	19 Axis#2 RVS "	0A Axis#1 Error	1A	0A	1A Axis#3 FWD "	0B Axis#2 "	1B	0B	1B Axis#3 RVS "	0C Axis#3 "	1C	0C	1C Axis#3 Stop	0D Axis#1 M Code	1D	0D	1D Ready	0E Axis#2 "	1E	0E	1E Not for use	0F Axis#3 "	1F	0F	1F Not for use	1)	---	---	---	---	---
X		Y																																																																								
00 AD75 Ready	10	00	10 Axis#1 Start																																																																							
01 Axis#1 Started	11	01	11 Axis#2 "																																																																							
02 Axis#2 "	12	02	12 Axis#3 "																																																																							
03 Axis#3 "	13	03	13 Axis#1 Stop																																																																							
04 Axis#1 BUSY	14	04	14 Axis#2 "																																																																							
05 Axis#2 "	15	05	15 Spar																																																																							
06 Axis#3 "	16	06	16 Axis#1 FWD JOG																																																																							
07 Axis#1 Completed	17	07	17 Axis#1 RVS "																																																																							
08 Axis#2 "	18	08	18 Axis#2 FWD "																																																																							
09 Axis#3 "	19	09	19 Axis#2 RVS "																																																																							
0A Axis#1 Error	1A	0A	1A Axis#3 FWD "																																																																							
0B Axis#2 "	1B	0B	1B Axis#3 RVS "																																																																							
0C Axis#3 "	1C	0C	1C Axis#3 Stop																																																																							
0D Axis#1 M Code	1D	0D	1D Ready																																																																							
0E Axis#2 "	1E	0E	1E Not for use																																																																							
0F Axis#3 "	1F	0F	1F Not for use																																																																							
<p>AD75P Operation Monitor Screen</p> <table border="1"> <thead> <tr> <th></th> <th>Axis 1</th> <th>Axis 2</th> <th>Axis 3</th> </tr> </thead> <tbody> <tr> <td>Address [$\times 10^{-5}$ inch]</td> <td>01234567890</td> <td>01234567890</td> <td>01234567890</td> </tr> <tr> <td>Axis Speed [$\times 10^{-3}$ inch/min]</td> <td>012345678</td> <td>012345678</td> <td>012345678</td> </tr> </tbody> </table> <table border="1"> <thead> <tr> <th>#</th> <th>Error</th> <th>Warning</th> <th>M Code</th> </tr> </thead> <tbody> <tr> <td>#1</td> <td>4) 012</td> <td>5) 012</td> <td>6) 01234</td> </tr> <tr> <td>#2</td> <td>012</td> <td>012</td> <td>01234</td> </tr> <tr> <td>#3</td> <td>012</td> <td>012</td> <td>01234</td> </tr> </tbody> </table> <table border="1"> <thead> <tr> <th>#</th> <th>No.</th> <th>Pattern</th> <th>Method</th> <th>Acc</th> <th>Dec</th> </tr> </thead> <tbody> <tr> <td>#1</td> <td>0123</td> <td></td> <td></td> <td>0</td> <td>0</td> </tr> <tr> <td>#2</td> <td>0123</td> <td></td> <td></td> <td>0</td> <td>0</td> </tr> <tr> <td>#3</td> <td>0123</td> <td></td> <td></td> <td>0</td> <td>0</td> </tr> </tbody> </table>		Axis 1	Axis 2	Axis 3	Address [$\times 10^{-5}$ inch]	01234567890	01234567890	01234567890	Axis Speed [$\times 10^{-3}$ inch/min]	012345678	012345678	012345678	#	Error	Warning	M Code	#1	4) 012	5) 012	6) 01234	#2	012	012	01234	#3	012	012	01234	#	No.	Pattern	Method	Acc	Dec	#1	0123			0	0	#2	0123			0	0	#3	0123			0	0	1)	800	0320	900	0384	1000	03E8															
	Axis 1	Axis 2	Axis 3																																																																							
Address [$\times 10^{-5}$ inch]	01234567890	01234567890	01234567890																																																																							
Axis Speed [$\times 10^{-3}$ inch/min]	012345678	012345678	012345678																																																																							
#	Error	Warning	M Code																																																																							
#1	4) 012	5) 012	6) 01234																																																																							
#2	012	012	01234																																																																							
#3	012	012	01234																																																																							
#	No.	Pattern	Method	Acc	Dec																																																																					
#1	0123			0	0																																																																					
#2	0123			0	0																																																																					
#3	0123			0	0																																																																					
		801	0321	901	0385	1001	03E9																																																																			
2)		812	032C	912	0390	1012	03F4																																																																			
		813	032D	913	0391	1013	03F5																																																																			
3)		809	0329	909	038D	1009	03F1																																																																			
4)		807	0327	907	038B	1007	03EF																																																																			
5)		808	0328	908	038C	1008	03F0																																																																			
6)		806	0326	906	038A	1006	03EE																																																																			
7)		835	0343	935	03A7	1035	040B																																																																			
8)																																																																										
9)		838	0346	938	03AA	1038	040E																																																																			
10)																																																																										
11)																																																																										
		---	---	---	---	---	---																																																																			
<p>AD75P Basic Parameter 1</p> <table border="1"> <thead> <tr> <th>Parameter</th> <th>Valid Range</th> <th>1Axis</th> <th>2Axis</th> <th>3Axis</th> </tr> </thead> <tbody> <tr> <td>Unit</td> <td>0:mm 1:inch 2:degree 3:PULSE</td> <td>0</td> <td>0</td> <td>0</td> </tr> <tr> <td>Pulse Per Revolution</td> <td>1 to 65535 [PLS]</td> <td>01234</td> <td>01234</td> <td>01234</td> </tr> <tr> <td>Travel Per Revolution</td> <td>0 to 65535 [$\times 10^{-5}$ inch] [$\times 10^{-5}$ degree] [PLS]</td> <td>01234</td> <td>01234</td> <td>01234</td> </tr> <tr> <td>Unit Multiplier</td> <td>1: x1 10: x10 100: x100 1000: x1000</td> <td>0123</td> <td>0123</td> <td>0123</td> </tr> <tr> <td>Pulse Output Mode</td> <td>0:PLS/SIGN Mode 1:CH/CCH Mode 2:A/B Mode</td> <td>0</td> <td>0</td> <td>0</td> </tr> <tr> <td>Rotation Direction</td> <td>0:Forward Pulses 1:Reverse Pulses</td> <td>0</td> <td>0</td> <td>0</td> </tr> </tbody> </table>	Parameter	Valid Range	1Axis	2Axis	3Axis	Unit	0:mm 1:inch 2:degree 3:PULSE	0	0	0	Pulse Per Revolution	1 to 65535 [PLS]	01234	01234	01234	Travel Per Revolution	0 to 65535 [$\times 10^{-5}$ inch] [$\times 10^{-5}$ degree] [PLS]	01234	01234	01234	Unit Multiplier	1: x1 10: x10 100: x100 1000: x1000	0123	0123	0123	Pulse Output Mode	0:PLS/SIGN Mode 1:CH/CCH Mode 2:A/B Mode	0	0	0	Rotation Direction	0:Forward Pulses 1:Reverse Pulses	0	0	0	1)	0	0000	150	0096	300	012C																																
Parameter	Valid Range	1Axis	2Axis	3Axis																																																																						
Unit	0:mm 1:inch 2:degree 3:PULSE	0	0	0																																																																						
Pulse Per Revolution	1 to 65535 [PLS]	01234	01234	01234																																																																						
Travel Per Revolution	0 to 65535 [$\times 10^{-5}$ inch] [$\times 10^{-5}$ degree] [PLS]	01234	01234	01234																																																																						
Unit Multiplier	1: x1 10: x10 100: x100 1000: x1000	0123	0123	0123																																																																						
Pulse Output Mode	0:PLS/SIGN Mode 1:CH/CCH Mode 2:A/B Mode	0	0	0																																																																						
Rotation Direction	0:Forward Pulses 1:Reverse Pulses	0	0	0																																																																						
		1	0001	151	0097	301	012D																																																																			
		2	0002	152	0098	302	012E																																																																			
		3	0003	153	0099	303	012F																																																																			
		4	0004	154	009A	304	0130																																																																			
		5	0005	155	009B	305	0131																																																																			
		---	---	---	---	---	---																																																																			

Screen Image		No.	Buffer memory address																																							
			1		2		3																																			
			dec.	hex.	dec.	hex.	dec.	hex.																																		
<p>AD75P Basic Parameter 2</p> <table border="1"> <thead> <tr> <th>Parameter</th> <th>Valid Range</th> <th>1Axis</th> <th>2Axis</th> <th>3Axis</th> </tr> </thead> <tbody> <tr> <td>Speed Limit</td> <td>1 to 600000000 [×10⁻⁵ mm/min] 1 to 600000000 [×10⁻³ inch/min] 1 to 600000000 [×10⁻³ deg/min] 0 to 1000000 [PLS/sec]</td> <td>012345678</td> <td>012345678</td> <td>012345678</td> </tr> <tr> <td>Accel.Time #0</td> <td>1 to 65535 [msec]</td> <td>01234</td> <td>01234</td> <td>01234</td> </tr> <tr> <td>Decel.Time #0</td> <td>1 to 65535 [msec]</td> <td>01234</td> <td>01234</td> <td>01234</td> </tr> </tbody> </table>	Parameter	Valid Range	1Axis	2Axis	3Axis	Speed Limit	1 to 600000000 [×10 ⁻⁵ mm/min] 1 to 600000000 [×10 ⁻³ inch/min] 1 to 600000000 [×10 ⁻³ deg/min] 0 to 1000000 [PLS/sec]	012345678	012345678	012345678	Accel.Time #0	1 to 65535 [msec]	01234	01234	01234	Decel.Time #0	1 to 65535 [msec]	01234	01234	01234	1)	6	0006	156	009C	306	0132															
	Parameter	Valid Range	1Axis	2Axis	3Axis																																					
	Speed Limit	1 to 600000000 [×10 ⁻⁵ mm/min] 1 to 600000000 [×10 ⁻³ inch/min] 1 to 600000000 [×10 ⁻³ deg/min] 0 to 1000000 [PLS/sec]	012345678	012345678	012345678																																					
	Accel.Time #0	1 to 65535 [msec]	01234	01234	01234																																					
	Decel.Time #0	1 to 65535 [msec]	01234	01234	01234																																					
			7	0007	157	009D	307	0133																																		
	2)	8	0008	158	009E	308	0134																																			
		9	0009	159	009F	309	0135																																			
	3)	10	000A	160	00A0	310	0136																																			
		11	000B	161	00A1	311	0137																																			
<p>AD75P Basic Parameter 2</p> <table border="1"> <thead> <tr> <th>Parameter</th> <th>Valid Range</th> <th>1Axis</th> <th>2Axis</th> <th>3Axis</th> </tr> </thead> <tbody> <tr> <td>Speed Limit</td> <td>1 to 600000000 [×10⁻⁵ mm/min] 1 to 600000000 [×10⁻³ inch/min] 1 to 600000000 [×10⁻³ deg/min] 0 to 1000000 [PLS/sec]</td> <td>012345678</td> <td>012345678</td> <td>012345678</td> </tr> <tr> <td>Accel.Time #0</td> <td>1 to 65535 [msec]</td> <td>01234</td> <td>01234</td> <td>01234</td> </tr> <tr> <td>Decel.Time #0</td> <td>1 to 65535 [msec]</td> <td>01234</td> <td>01234</td> <td>01234</td> </tr> </tbody> </table>	Parameter	Valid Range	1Axis	2Axis	3Axis	Speed Limit	1 to 600000000 [×10 ⁻⁵ mm/min] 1 to 600000000 [×10 ⁻³ inch/min] 1 to 600000000 [×10 ⁻³ deg/min] 0 to 1000000 [PLS/sec]	012345678	012345678	012345678	Accel.Time #0	1 to 65535 [msec]	01234	01234	01234	Decel.Time #0	1 to 65535 [msec]	01234	01234	01234	1)	15	000F	165	00A5	315	013B															
	Parameter	Valid Range	1Axis	2Axis	3Axis																																					
	Speed Limit	1 to 600000000 [×10 ⁻⁵ mm/min] 1 to 600000000 [×10 ⁻³ inch/min] 1 to 600000000 [×10 ⁻³ deg/min] 0 to 1000000 [PLS/sec]	012345678	012345678	012345678																																					
	Accel.Time #0	1 to 65535 [msec]	01234	01234	01234																																					
	Decel.Time #0	1 to 65535 [msec]	01234	01234	01234																																					
		2)	16	0010	166	00A6	316	013C																																		
			17	0011	167	00A7	317	013D																																		
	3)	18	0012	168	00A8	318	013E																																			
		19	0013	169	00A9	319	013F																																			
	4)	20	0014	170	00AA	320	0140																																			
	5)	21	0015	171	00AB	321	0141																																			
	6)	24	0018	174	00AE	324	0144																																			
<p>AD75P Extended Parameter 2</p> <table border="1"> <thead> <tr> <th>Parameter</th> <th>Valid Range</th> <th>Axis1</th> <th>Axis2</th> <th>Axis3</th> </tr> </thead> <tbody> <tr> <td>Accel.Time#1</td> <td>1 to 65535 [msec]</td> <td>012345</td> <td>012345</td> <td>012345</td> </tr> <tr> <td>Accel.Time#2</td> <td>1 to 65535 [msec]</td> <td>012345</td> <td>012345</td> <td>012345</td> </tr> <tr> <td>Accel.Time#3</td> <td>1 to 65535 [msec]</td> <td>012345</td> <td>012345</td> <td>012345</td> </tr> <tr> <td>Decel.Time#1</td> <td>1 to 65535 [msec]</td> <td>012345</td> <td>012345</td> <td>012345</td> </tr> <tr> <td>Decel.Time#2</td> <td>1 to 65535 [msec]</td> <td>012345</td> <td>012345</td> <td>012345</td> </tr> <tr> <td>Decel.Time#3</td> <td>1 to 65535 [msec]</td> <td>012345</td> <td>012345</td> <td>012345</td> </tr> </tbody> </table>	Parameter	Valid Range	Axis1	Axis2	Axis3	Accel.Time#1	1 to 65535 [msec]	012345	012345	012345	Accel.Time#2	1 to 65535 [msec]	012345	012345	012345	Accel.Time#3	1 to 65535 [msec]	012345	012345	012345	Decel.Time#1	1 to 65535 [msec]	012345	012345	012345	Decel.Time#2	1 to 65535 [msec]	012345	012345	012345	Decel.Time#3	1 to 65535 [msec]	012345	012345	012345	1)	36 to 41	0024 to 0029	186 to 191	00BA to 00BF	336 to 341	0150 to 0155
	Parameter	Valid Range	Axis1	Axis2	Axis3																																					
	Accel.Time#1	1 to 65535 [msec]	012345	012345	012345																																					
	Accel.Time#2	1 to 65535 [msec]	012345	012345	012345																																					
	Accel.Time#3	1 to 65535 [msec]	012345	012345	012345																																					
	Decel.Time#1	1 to 65535 [msec]	012345	012345	012345																																					
Decel.Time#2	1 to 65535 [msec]	012345	012345	012345																																						
Decel.Time#3	1 to 65535 [msec]	012345	012345	012345																																						
	2)	42 to 47	002A to 002F	192 to 197	00C0 to 00C5	342 to 347	0156 to 015B																																			

Screen Image	No.	Buffer memory address																																																																																																																																																					
		1		2		3																																																																																																																																																	
		dec.	hex.	dec.	hex.	dec.	hex.																																																																																																																																																
<p>AD75P OPR Basic Parameter</p> <table border="1"> <thead> <tr> <th>Parameter</th> <th>Valid Range</th> <th>1Axis</th> <th>2Axis</th> <th>3Axis</th> </tr> </thead> <tbody> <tr> <td>Method</td> <td>0:DOG 4:Count#1 1:Stopper#1 5:Count#2 2:Stopper#2 3:Stopper#3</td> <td>0</td> <td>0</td> <td>0</td> </tr> <tr> <td>Direction</td> <td>0:Forward 1:Reverse -2147483648 to 2147483647 [x10⁻¹ μm] [x10⁻⁵ inch] [PLS]</td> <td>0</td> <td>0</td> <td>0</td> </tr> <tr> <td>Address</td> <td>0 to 35999999 [x10⁻⁵ deg] [x10⁻² mm/min] [x10⁻³ inch/mm] [x10⁻³ deg/mm] 1 to 1000000 [PLS/sec] [x10⁻² mm/min] [x10⁻³ inch/mm] [x10⁻³ deg/mm] 1 to 1000000 [PLS/sec]</td> <td>0123456789</td> <td>0123456789</td> <td>0123456789</td> </tr> <tr> <td>Return Speed</td> <td>0 to 65535 [msec]</td> <td>01234</td> <td>01234</td> <td>01234</td> </tr> <tr> <td>Creep Speed</td> <td>0 to 35999999 [x10⁻⁵ deg]</td> <td>0</td> <td>0</td> <td>0</td> </tr> <tr> <td>Return Retry</td> <td>0:No Retru 1:retru</td> <td>0</td> <td>0</td> <td>0</td> </tr> </tbody> </table>	Parameter	Valid Range	1Axis	2Axis	3Axis	Method	0:DOG 4:Count#1 1:Stopper#1 5:Count#2 2:Stopper#2 3:Stopper#3	0	0	0	Direction	0:Forward 1:Reverse -2147483648 to 2147483647 [x10 ⁻¹ μm] [x10 ⁻⁵ inch] [PLS]	0	0	0	Address	0 to 35999999 [x10 ⁻⁵ deg] [x10 ⁻² mm/min] [x10 ⁻³ inch/mm] [x10 ⁻³ deg/mm] 1 to 1000000 [PLS/sec] [x10 ⁻² mm/min] [x10 ⁻³ inch/mm] [x10 ⁻³ deg/mm] 1 to 1000000 [PLS/sec]	0123456789	0123456789	0123456789	Return Speed	0 to 65535 [msec]	01234	01234	01234	Creep Speed	0 to 35999999 [x10 ⁻⁵ deg]	0	0	0	Return Retry	0:No Retru 1:retru	0	0	0	1)	70	0046	220	00DC	370	0172																																																																																																													
	Parameter	Valid Range	1Axis	2Axis	3Axis																																																																																																																																																		
	Method	0:DOG 4:Count#1 1:Stopper#1 5:Count#2 2:Stopper#2 3:Stopper#3	0	0	0																																																																																																																																																		
	Direction	0:Forward 1:Reverse -2147483648 to 2147483647 [x10 ⁻¹ μm] [x10 ⁻⁵ inch] [PLS]	0	0	0																																																																																																																																																		
	Address	0 to 35999999 [x10 ⁻⁵ deg] [x10 ⁻² mm/min] [x10 ⁻³ inch/mm] [x10 ⁻³ deg/mm] 1 to 1000000 [PLS/sec] [x10 ⁻² mm/min] [x10 ⁻³ inch/mm] [x10 ⁻³ deg/mm] 1 to 1000000 [PLS/sec]	0123456789	0123456789	0123456789																																																																																																																																																		
	Return Speed	0 to 65535 [msec]	01234	01234	01234																																																																																																																																																		
Creep Speed	0 to 35999999 [x10 ⁻⁵ deg]	0	0	0																																																																																																																																																			
Return Retry	0:No Retru 1:retru	0	0	0																																																																																																																																																			
	2)	71	0047	221	00DD	371	0173																																																																																																																																																
	3)	72	0048	222	00DE	372	0174																																																																																																																																																
		73	0049	223	00DF	373	0175																																																																																																																																																
	4)	74	004A	224	00E0	374	0176																																																																																																																																																
		75	004B	225	00E1	375	0177																																																																																																																																																
	5)	76	004C	226	00E2	376	0178																																																																																																																																																
		77	004D	227	00E3	377	0179																																																																																																																																																
	6)	78	004E	228	00E4	378	017A																																																																																																																																																
<p>AD75P OPR Extended Parameter</p> <table border="1"> <thead> <tr> <th>Parameter</th> <th>Valid Range</th> <th>1Axis</th> <th>2Axis</th> <th>3Axis</th> </tr> </thead> <tbody> <tr> <td>OPR Dwell Time</td> <td>0 to 65535 [msec]</td> <td>01234</td> <td>01234</td> <td>01234</td> </tr> <tr> <td>OPR Torque Limit</td> <td>1 to 300 [%]</td> <td>012</td> <td>012</td> <td>012</td> </tr> <tr> <td>Travel Distance After DOG</td> <td>0 to 2147483647 [x10⁻¹ μm] [x10⁻⁵ inch] [x10⁻⁵ deg] [PLS]</td> <td>0123456789</td> <td>0123456789</td> <td>0123456789</td> </tr> <tr> <td>OPR Accel. Time</td> <td>0 to 3</td> <td>0</td> <td>0</td> <td>0</td> </tr> <tr> <td>OPR Decel. Time</td> <td>0 to 3</td> <td>0</td> <td>0</td> <td>0</td> </tr> <tr> <td>OP Distance</td> <td>-2147483648 to 2147483647 [x10⁻¹ μm] [x10⁻⁵ inch] [PLS]</td> <td>0123456789</td> <td>0123456789</td> <td>0123456789</td> </tr> <tr> <td>From Zero</td> <td>0 to 35999999 [x10⁻⁵ deg]</td> <td></td> <td></td> <td></td> </tr> </tbody> </table>	Parameter	Valid Range	1Axis	2Axis	3Axis	OPR Dwell Time	0 to 65535 [msec]	01234	01234	01234	OPR Torque Limit	1 to 300 [%]	012	012	012	Travel Distance After DOG	0 to 2147483647 [x10 ⁻¹ μm] [x10 ⁻⁵ inch] [x10 ⁻⁵ deg] [PLS]	0123456789	0123456789	0123456789	OPR Accel. Time	0 to 3	0	0	0	OPR Decel. Time	0 to 3	0	0	0	OP Distance	-2147483648 to 2147483647 [x10 ⁻¹ μm] [x10 ⁻⁵ inch] [PLS]	0123456789	0123456789	0123456789	From Zero	0 to 35999999 [x10 ⁻⁵ deg]				1)	79	004F	229	00E5	379	017B																																																																																																								
	Parameter	Valid Range	1Axis	2Axis	3Axis																																																																																																																																																		
	OPR Dwell Time	0 to 65535 [msec]	01234	01234	01234																																																																																																																																																		
	OPR Torque Limit	1 to 300 [%]	012	012	012																																																																																																																																																		
	Travel Distance After DOG	0 to 2147483647 [x10 ⁻¹ μm] [x10 ⁻⁵ inch] [x10 ⁻⁵ deg] [PLS]	0123456789	0123456789	0123456789																																																																																																																																																		
	OPR Accel. Time	0 to 3	0	0	0																																																																																																																																																		
OPR Decel. Time	0 to 3	0	0	0																																																																																																																																																			
OP Distance	-2147483648 to 2147483647 [x10 ⁻¹ μm] [x10 ⁻⁵ inch] [PLS]	0123456789	0123456789	0123456789																																																																																																																																																			
From Zero	0 to 35999999 [x10 ⁻⁵ deg]																																																																																																																																																						
	2)	86	0056	236	00EC	386	0182																																																																																																																																																
	3)	80	0050	230	00E6	380	017C																																																																																																																																																
		81	0051	231	00E7	381	017D																																																																																																																																																
	4)	82	0052	232	00E8	382	017E																																																																																																																																																
		83	0053	233	00E9	383	017F																																																																																																																																																
	6)	84	0054	234	00EA	384	0180																																																																																																																																																
		85	0055	235	00EB	385	0181																																																																																																																																																
<p>AD75P Error History . Warning History</p> <table border="1"> <thead> <tr> <th colspan="4">[Error History]</th> <th colspan="4">[Warning History]</th> </tr> <tr> <th>No.</th> <th>Ax.</th> <th>Code</th> <th>Time</th> <th>No.</th> <th>Ax.</th> <th>Code</th> <th>Time</th> </tr> </thead> <tbody> <tr><td>1</td><td>○</td><td>012</td><td>00:00:00.00</td><td>1</td><td>○</td><td>012</td><td>00:00:00.00</td></tr> <tr><td>2</td><td>○</td><td>012</td><td>00:00:00.00</td><td>2</td><td>○</td><td>012</td><td>00:00:00.00</td></tr> <tr><td>3</td><td>○</td><td>012</td><td>00:00:00.00</td><td>3</td><td>○</td><td>012</td><td>00:00:00.00</td></tr> <tr><td>4</td><td>○</td><td>012</td><td>00:00:00.00</td><td>4</td><td>○</td><td>012</td><td>00:00:00.00</td></tr> <tr><td>5</td><td>○</td><td>012</td><td>00:00:00.00</td><td>5</td><td>○</td><td>012</td><td>00:00:00.00</td></tr> <tr><td>6</td><td>○</td><td>012</td><td>00:00:00.00</td><td>6</td><td>○</td><td>012</td><td>00:00:00.00</td></tr> <tr><td>7</td><td>○</td><td>012</td><td>00:00:00.00</td><td>7</td><td>○</td><td>012</td><td>00:00:00.00</td></tr> <tr><td>8</td><td>○</td><td>012</td><td>00:00:00.00</td><td>8</td><td>○</td><td>012</td><td>00:00:00.00</td></tr> <tr><td>9</td><td>○</td><td>012</td><td>00:00:00.00</td><td>9</td><td>○</td><td>012</td><td>00:00:00.00</td></tr> <tr><td>10</td><td>○</td><td>012</td><td>00:00:00.00</td><td>10</td><td>○</td><td>012</td><td>00:00:00.00</td></tr> <tr><td>11</td><td>○</td><td>012</td><td>00:00:00.00</td><td>11</td><td>○</td><td>012</td><td>00:00:00.00</td></tr> <tr><td>12</td><td>○</td><td>012</td><td>00:00:00.00</td><td>12</td><td>○</td><td>012</td><td>00:00:00.00</td></tr> <tr><td>13</td><td>○</td><td>012</td><td>00:00:00.00</td><td>13</td><td>○</td><td>012</td><td>00:00:00.00</td></tr> <tr><td>14</td><td>○</td><td>012</td><td>00:00:00.00</td><td>14</td><td>○</td><td>012</td><td>00:00:00.00</td></tr> <tr><td>15</td><td>○</td><td>012</td><td>00:00:00.00</td><td>15</td><td>○</td><td>012</td><td>00:00:00.00</td></tr> <tr><td>16</td><td>○</td><td>012</td><td>00:00:00.00</td><td>16</td><td>○</td><td>012</td><td>00:00:00.00</td></tr> </tbody> </table>	[Error History]				[Warning History]				No.	Ax.	Code	Time	No.	Ax.	Code	Time	1	○	012	00:00:00.00	1	○	012	00:00:00.00	2	○	012	00:00:00.00	2	○	012	00:00:00.00	3	○	012	00:00:00.00	3	○	012	00:00:00.00	4	○	012	00:00:00.00	4	○	012	00:00:00.00	5	○	012	00:00:00.00	5	○	012	00:00:00.00	6	○	012	00:00:00.00	6	○	012	00:00:00.00	7	○	012	00:00:00.00	7	○	012	00:00:00.00	8	○	012	00:00:00.00	8	○	012	00:00:00.00	9	○	012	00:00:00.00	9	○	012	00:00:00.00	10	○	012	00:00:00.00	10	○	012	00:00:00.00	11	○	012	00:00:00.00	11	○	012	00:00:00.00	12	○	012	00:00:00.00	12	○	012	00:00:00.00	13	○	012	00:00:00.00	13	○	012	00:00:00.00	14	○	012	00:00:00.00	14	○	012	00:00:00.00	15	○	012	00:00:00.00	15	○	012	00:00:00.00	16	○	012	00:00:00.00	16	○	012	00:00:00.00	1)	624	0270	624	0270	624	0270
	[Error History]				[Warning History]																																																																																																																																																		
	No.	Ax.	Code	Time	No.	Ax.	Code	Time																																																																																																																																															
	1	○	012	00:00:00.00	1	○	012	00:00:00.00																																																																																																																																															
2	○	012	00:00:00.00	2	○	012	00:00:00.00																																																																																																																																																
3	○	012	00:00:00.00	3	○	012	00:00:00.00																																																																																																																																																
4	○	012	00:00:00.00	4	○	012	00:00:00.00																																																																																																																																																
5	○	012	00:00:00.00	5	○	012	00:00:00.00																																																																																																																																																
6	○	012	00:00:00.00	6	○	012	00:00:00.00																																																																																																																																																
7	○	012	00:00:00.00	7	○	012	00:00:00.00																																																																																																																																																
8	○	012	00:00:00.00	8	○	012	00:00:00.00																																																																																																																																																
9	○	012	00:00:00.00	9	○	012	00:00:00.00																																																																																																																																																
10	○	012	00:00:00.00	10	○	012	00:00:00.00																																																																																																																																																
11	○	012	00:00:00.00	11	○	012	00:00:00.00																																																																																																																																																
12	○	012	00:00:00.00	12	○	012	00:00:00.00																																																																																																																																																
13	○	012	00:00:00.00	13	○	012	00:00:00.00																																																																																																																																																
14	○	012	00:00:00.00	14	○	012	00:00:00.00																																																																																																																																																
15	○	012	00:00:00.00	15	○	012	00:00:00.00																																																																																																																																																
16	○	012	00:00:00.00	16	○	012	00:00:00.00																																																																																																																																																
		to	to	to	to	to	to																																																																																																																																																
		687	02AF	687	02AF	687	02AF																																																																																																																																																
	2)	689	02B1	689	02B1	689	02B1																																																																																																																																																
		to	to	to	to	to	to																																																																																																																																																
		752	02F0	752	02F0	752	02F0																																																																																																																																																

Screen Image	No.	Buffer memory address					
		1		2		3	
		dec.	hex.	dec.	hex.	dec.	hex.
	1)	543 to 622	021F to 026E	543 to 622	021F to 026E	543 to 622	021F to 026E
	2)	462 to 541	01CE to 021D	462 to 541	01CE to 021D	462 to 541	01CE to 021D
	1)	814 to 815	032E to 032F	914 to 915	0392 to 0393	1014 to 1015	03F6 to 03F7
	2)	1164 to 1165	048C to 048D	1214 to 1215	04BE to 04BF	1264 to 1265	04F0 to 04F1
	3)	817	0331	917	0395	1017	03F9
	4)	1163	048B	1213	04BD	1263	04EF
	5)	817	0331	917	0395	1017	03F9
	1)	832 to 828 to 829	0340 to 033C to 033D	932 to 928 to 929	03A4 to 039F to 03A0 to 03A1	1032 to 1027 to 1028 to 1029	0408 to 0403 to 0404 to 0405
	2)	1160 to 1161	0488 to 0489	1210 to 1211	04BA to 04BB	1260 to 1261	04EC to 04ED
	3)	1168 to 1169	0490 to 0491	1218 to 1219	04C2 to 04C3	1268 to 1269	04F4 to 04F5
	4)	1167	048F	1217	04C1	1267	04F3
	—	—	—	—	—	—	—
	—	—	—	—	—	—	—
	—	—	—	—	—	—	—

Screen Image	No.	Buffer memory address																																													
		1		2		3																																									
		dec.	hex.	dec.	hex.	dec.	hex.																																								
<p>AD75P Original Point Return</p> <table border="1"> <thead> <tr> <th colspan="2"></th> <th>Axis1</th> <th>Axis2</th> <th>Axis3</th> </tr> </thead> <tbody> <tr> <td>Absolute Original Point</td> <td>[$\times 10^{-1}$ μm] [$\times 10^{-5}$ inch] [$\times 10^{-5}$ deg] [PLS]</td> <td>01234567890</td> <td>01234567890</td> <td>01234567890</td> </tr> <tr> <td>Travel Distance After DOG</td> <td>[$\times 10^{-1}$ μm] [$\times 10^{-5}$ inch] [PLS]</td> <td>01234567890</td> <td>01234567890</td> <td>01234567890</td> </tr> </tbody> </table> <table border="1"> <thead> <tr> <th></th> <th>Torque Limit</th> <th>ZeroSignal</th> <th>DOG Signal</th> <th>UpperLimit</th> <th>LowerLimit</th> </tr> </thead> <tbody> <tr> <td>1Axis</td> <td>012 [%]</td> <td><input type="checkbox"/></td> <td><input checked="" type="checkbox"/></td> <td><input checked="" type="checkbox"/></td> <td><input checked="" type="checkbox"/></td> </tr> <tr> <td>2Axis</td> <td>012 [%]</td> <td><input checked="" type="checkbox"/></td> <td><input checked="" type="checkbox"/></td> <td><input checked="" type="checkbox"/></td> <td><input checked="" type="checkbox"/></td> </tr> <tr> <td>3Axis</td> <td>012 [%]</td> <td><input type="checkbox"/></td> <td><input checked="" type="checkbox"/></td> <td><input type="checkbox"/></td> <td><input checked="" type="checkbox"/></td> </tr> </tbody> </table> <p>1) Absolute Original Point 2) Travel Distance After DOG 3) Torque Limit 4) ZeroSignal 5) DOG Signal 6) UpperLimit 7) LowerLimit</p>			Axis1	Axis2	Axis3	Absolute Original Point	[$\times 10^{-1}$ μ m] [$\times 10^{-5}$ inch] [$\times 10^{-5}$ deg] [PLS]	01234567890	01234567890	01234567890	Travel Distance After DOG	[$\times 10^{-1}$ μ m] [$\times 10^{-5}$ inch] [PLS]	01234567890	01234567890	01234567890		Torque Limit	ZeroSignal	DOG Signal	UpperLimit	LowerLimit	1Axis	012 [%]	<input type="checkbox"/>	<input checked="" type="checkbox"/>	<input checked="" type="checkbox"/>	<input checked="" type="checkbox"/>	2Axis	012 [%]	<input checked="" type="checkbox"/>	<input checked="" type="checkbox"/>	<input checked="" type="checkbox"/>	<input checked="" type="checkbox"/>	3Axis	012 [%]	<input type="checkbox"/>	<input checked="" type="checkbox"/>	<input type="checkbox"/>	<input checked="" type="checkbox"/>	1)	822	0336	922	039A	1022	03FE	
			Axis1	Axis2	Axis3																																										
	Absolute Original Point	[$\times 10^{-1}$ μ m] [$\times 10^{-5}$ inch] [$\times 10^{-5}$ deg] [PLS]	01234567890	01234567890	01234567890																																										
	Travel Distance After DOG	[$\times 10^{-1}$ μ m] [$\times 10^{-5}$ inch] [PLS]	01234567890	01234567890	01234567890																																										
		Torque Limit	ZeroSignal	DOG Signal	UpperLimit	LowerLimit																																									
	1Axis	012 [%]	<input type="checkbox"/>	<input checked="" type="checkbox"/>	<input checked="" type="checkbox"/>	<input checked="" type="checkbox"/>																																									
	2Axis	012 [%]	<input checked="" type="checkbox"/>	<input checked="" type="checkbox"/>	<input checked="" type="checkbox"/>	<input checked="" type="checkbox"/>																																									
3Axis	012 [%]	<input type="checkbox"/>	<input checked="" type="checkbox"/>	<input type="checkbox"/>	<input checked="" type="checkbox"/>																																										
		823	0337	923	039B	1023	03FF																																								
	2)	824	0338	924	039C	1024	0400																																								
		825	0339	925	039D	1025	0401																																								
	3)	826	033A	926	039E	1026	0402																																								
	4)																																														
	5)	816	0330	916	0394	1016	03F8																																								
	6)																																														
	7)																																														
<p>AD75P Axis Control Data</p> <table border="1"> <thead> <tr> <th colspan="2"></th> <th>Axis1</th> <th>Axis2</th> <th>Axis3</th> </tr> </thead> <tbody> <tr> <td>Correcting Address</td> <td>[$\times 10^{-1}$ μm] [$\times 10^{-5}$ inch] [$\times 10^{-5}$ deg] [PLS]</td> <td>01234567890</td> <td>01234567890</td> <td>01234567890</td> </tr> <tr> <td>Correcting Speed</td> <td>[$\times 10^{-5}$ mm/min] [$\times 10^{-3}$ inch/min] [$\times 10^{-3}$ deg/min] [PLS/sec]</td> <td>012345678</td> <td>012345678</td> <td>012345678</td> </tr> <tr> <td>Speed Dump</td> <td>[%]</td> <td>012</td> <td>012</td> <td>012</td> </tr> <tr> <td>Step Valid Flag</td> <td>0:Disable 1:Enable</td> <td>0</td> <td>0</td> <td>0</td> </tr> <tr> <td>Step Mode</td> <td>0:Dec Unit 1:Data No.</td> <td>0</td> <td>0</td> <td>0</td> </tr> <tr> <td>Skip Command</td> <td>0:Completed 1:Req.</td> <td>0</td> <td>0</td> <td>0</td> </tr> <tr> <td>EXT.Start Enable</td> <td>0:Disable 1:Enable</td> <td>0</td> <td>0</td> <td>0</td> </tr> </tbody> </table> <p>1) Correcting Address 2) Correcting Speed 3) Speed Dump 4) Step Valid Flag 5) Step Mode 6) Skip Command 7) EXT.Start Enable</p>			Axis1	Axis2	Axis3	Correcting Address	[$\times 10^{-1}$ μ m] [$\times 10^{-5}$ inch] [$\times 10^{-5}$ deg] [PLS]	01234567890	01234567890	01234567890	Correcting Speed	[$\times 10^{-5}$ mm/min] [$\times 10^{-3}$ inch/min] [$\times 10^{-3}$ deg/min] [PLS/sec]	012345678	012345678	012345678	Speed Dump	[%]	012	012	012	Step Valid Flag	0:Disable 1:Enable	0	0	0	Step Mode	0:Dec Unit 1:Data No.	0	0	0	Skip Command	0:Completed 1:Req.	0	0	0	EXT.Start Enable	0:Disable 1:Enable	0	0	0	1)	1154	0482	1204	04B4	1254	04E6
			Axis1	Axis2	Axis3																																										
	Correcting Address	[$\times 10^{-1}$ μ m] [$\times 10^{-5}$ inch] [$\times 10^{-5}$ deg] [PLS]	01234567890	01234567890	01234567890																																										
	Correcting Speed	[$\times 10^{-5}$ mm/min] [$\times 10^{-3}$ inch/min] [$\times 10^{-3}$ deg/min] [PLS/sec]	012345678	012345678	012345678																																										
	Speed Dump	[%]	012	012	012																																										
	Step Valid Flag	0:Disable 1:Enable	0	0	0																																										
	Step Mode	0:Dec Unit 1:Data No.	0	0	0																																										
Skip Command	0:Completed 1:Req.	0	0	0																																											
EXT.Start Enable	0:Disable 1:Enable	0	0	0																																											
		1155	0483	1205	04B5	1255	04E7																																								
	2)	1156	0484	1206	04B6	1256	04E8																																								
		1157	0485	1207	04B7	1257	04E9																																								
	3)	1159	0487	1209	04B9	1259	04EB																																								
	4)	1172	0494	1222	04C6	1272	04F8																																								
	5)	1173	0495	1223	04C7	1273	04F9																																								
	6)	1175	0497	1225	04C9	1275	04FB																																								
	7)	1171	0493	1221	04C5	1271	04F7																																								
<p>AD75P Output Speed</p> <table border="1"> <thead> <tr> <th colspan="2"></th> <th>Axis1</th> <th>Axis2</th> <th>Axis3</th> </tr> </thead> <tbody> <tr> <td>Target Speed</td> <td>[$\times 10^{-5}$ mm/min] [$\times 10^{-3}$ inch/min] [$\times 10^{-3}$ deg/min] [PLS/sec]</td> <td>012345678</td> <td>012345678</td> <td>012345678</td> </tr> <tr> <td>Current Speed</td> <td>[$\times 10^{-5}$ mm/min] [$\times 10^{-3}$ inch/min] [$\times 10^{-3}$ deg/min] [PLS/sec]</td> <td>012345678</td> <td>012345678</td> <td>012345678</td> </tr> <tr> <td>Axis Speed</td> <td>[$\times 10^{-5}$ mm/min] [$\times 10^{-3}$ inch/min] [$\times 10^{-3}$ deg/min] [PLS/sec]</td> <td>012345678</td> <td>012345678</td> <td>012345678</td> </tr> </tbody> </table> <p>1) Target Speed 2) Current Speed 3) Axis Speed</p>			Axis1	Axis2	Axis3	Target Speed	[$\times 10^{-5}$ mm/min] [$\times 10^{-3}$ inch/min] [$\times 10^{-3}$ deg/min] [PLS/sec]	012345678	012345678	012345678	Current Speed	[$\times 10^{-5}$ mm/min] [$\times 10^{-3}$ inch/min] [$\times 10^{-3}$ deg/min] [PLS/sec]	012345678	012345678	012345678	Axis Speed	[$\times 10^{-5}$ mm/min] [$\times 10^{-3}$ inch/min] [$\times 10^{-3}$ deg/min] [PLS/sec]	012345678	012345678	012345678	1)	820	0334	920	0398	1020	03FC																				
			Axis1	Axis2	Axis3																																										
	Target Speed	[$\times 10^{-5}$ mm/min] [$\times 10^{-3}$ inch/min] [$\times 10^{-3}$ deg/min] [PLS/sec]	012345678	012345678	012345678																																										
	Current Speed	[$\times 10^{-5}$ mm/min] [$\times 10^{-3}$ inch/min] [$\times 10^{-3}$ deg/min] [PLS/sec]	012345678	012345678	012345678																																										
	Axis Speed	[$\times 10^{-5}$ mm/min] [$\times 10^{-3}$ inch/min] [$\times 10^{-3}$ deg/min] [PLS/sec]	012345678	012345678	012345678																																										
			821	0335	921	0399	1021	03FD																																							
		2)	810	032A	910	038E	1010	03F2																																							
		811	032B	911	038F	1011	03F3																																								
	3)	812	032C	912	0390	1012	03F4																																								
		813	032D	913	0391	1013	03F5																																								

Screen Image		No.	Buffer memory address																																																																																												
			1		2		3																																																																																								
			dec.	hex.	dec.	hex.	dec.	hex.																																																																																							
<p>AD75P Destination . Mechanical Val</p> <table border="1"> <thead> <tr> <th></th> <th>Axis1</th> <th>Axis2</th> <th>Axis3</th> </tr> </thead> <tbody> <tr> <td>1) Destina [$\times 10^{-1}$ μm] [$\times 10^{-5}$ inch] [$\times 10^{-5}$ deg] [PLS]</td> <td>01234567890</td> <td>01234567890</td> <td>01234567890</td> </tr> <tr> <td>2) Mechanical Address [$\times 10^{-1}$ μm] [$\times 10^{-5}$ inch] [$\times 10^{-5}$ deg] [PLS]</td> <td>01234567890</td> <td>01234567890</td> <td>01234567890</td> </tr> </tbody> </table>		Axis1	Axis2	Axis3	1) Destina [$\times 10^{-1}$ μ m] [$\times 10^{-5}$ inch] [$\times 10^{-5}$ deg] [PLS]	01234567890	01234567890	01234567890	2) Mechanical Address [$\times 10^{-1}$ μ m] [$\times 10^{-5}$ inch] [$\times 10^{-5}$ deg] [PLS]	01234567890	01234567890	01234567890	1)	818	0332	918	0396	1018	03FA																																																																												
		Axis1	Axis2	Axis3																																																																																											
	1) Destina [$\times 10^{-1}$ μ m] [$\times 10^{-5}$ inch] [$\times 10^{-5}$ deg] [PLS]	01234567890	01234567890	01234567890																																																																																											
	2) Mechanical Address [$\times 10^{-1}$ μ m] [$\times 10^{-5}$ inch] [$\times 10^{-5}$ deg] [PLS]	01234567890	01234567890	01234567890																																																																																											
	819	0333	919	0397	1019	03FB																																																																																									
2)	802	0322	902	0386	1002	03EA																																																																																									
	803	0323	903	0387	1003	03EB																																																																																									
<p>AD75P External Input/Output . Status Info</p> <p>[External I/O] [Status Info]</p> <table border="1"> <thead> <tr> <th></th> <th>#1</th> <th>#2</th> <th>#3</th> <th></th> <th>#1</th> <th>#2</th> <th>#3</th> </tr> </thead> <tbody> <tr> <td>DriveUnitReady</td> <td>●</td> <td>○</td> <td>●</td> <td>V-Control</td> <td>○</td> <td>●</td> <td>○</td> </tr> <tr> <td>Zero Phase Signal</td> <td>○</td> <td>○</td> <td>○</td> <td>V/P Switch Latch</td> <td>○</td> <td>○</td> <td>○</td> </tr> <tr> <td>In-Positio Signal</td> <td>○</td> <td>○</td> <td>○</td> <td>Cmd In-Position</td> <td>○</td> <td>○</td> <td>○</td> </tr> <tr> <td>DOG Signal</td> <td>○</td> <td>○</td> <td>○</td> <td>OPR Request</td> <td>○</td> <td>○</td> <td>○</td> </tr> <tr> <td>Stop Signal</td> <td>○</td> <td>○</td> <td>○</td> <td>OPR Completion</td> <td>○</td> <td>○</td> <td>○</td> </tr> <tr> <td>Upper Limit</td> <td>○</td> <td>○</td> <td>○</td> <td>Axis Warning</td> <td>○</td> <td>○</td> <td>○</td> </tr> <tr> <td>Lower Limit</td> <td>○</td> <td>○</td> <td>○</td> <td>Speed Change 0</td> <td>○</td> <td>○</td> <td>○</td> </tr> <tr> <td>External Start</td> <td>○</td> <td>○</td> <td>○</td> <td>OP ABS Over</td> <td>○</td> <td>○</td> <td>○</td> </tr> <tr> <td>V/P Switch</td> <td>○</td> <td>○</td> <td>○</td> <td>OP ABS Under</td> <td>○</td> <td>○</td> <td>○</td> </tr> <tr> <td>DCC Signal Output</td> <td>●</td> <td>○</td> <td>○</td> <td></td> <td></td> <td></td> <td></td> </tr> </tbody> </table>		#1	#2	#3		#1	#2	#3	DriveUnitReady	●	○	●	V-Control	○	●	○	Zero Phase Signal	○	○	○	V/P Switch Latch	○	○	○	In-Positio Signal	○	○	○	Cmd In-Position	○	○	○	DOG Signal	○	○	○	OPR Request	○	○	○	Stop Signal	○	○	○	OPR Completion	○	○	○	Upper Limit	○	○	○	Axis Warning	○	○	○	Lower Limit	○	○	○	Speed Change 0	○	○	○	External Start	○	○	○	OP ABS Over	○	○	○	V/P Switch	○	○	○	OP ABS Under	○	○	○	DCC Signal Output	●	○	○					1)	816	0330	916	0394	1016	03F8
		#1	#2	#3		#1	#2	#3																																																																																							
	DriveUnitReady	●	○	●	V-Control	○	●	○																																																																																							
	Zero Phase Signal	○	○	○	V/P Switch Latch	○	○	○																																																																																							
In-Positio Signal	○	○	○	Cmd In-Position	○	○	○																																																																																								
DOG Signal	○	○	○	OPR Request	○	○	○																																																																																								
Stop Signal	○	○	○	OPR Completion	○	○	○																																																																																								
Upper Limit	○	○	○	Axis Warning	○	○	○																																																																																								
Lower Limit	○	○	○	Speed Change 0	○	○	○																																																																																								
External Start	○	○	○	OP ABS Over	○	○	○																																																																																								
V/P Switch	○	○	○	OP ABS Under	○	○	○																																																																																								
DCC Signal Output	●	○	○																																																																																												
	817	0331	917	0395	1017	03F9																																																																																									
<p>AD75P Positioning Information Monitor Screen No. 1</p> <table border="1"> <thead> <tr> <th>No.</th> <th>Pat</th> <th>Me</th> <th>thod</th> <th>Address</th> <th>Arc Address</th> <th>Speed</th> <th>Dwell Time</th> <th>M Code</th> </tr> </thead> <tbody> <tr> <td>1</td> <td>01</td> <td>01</td> <td>01</td> <td>01234567890</td> <td>01234567890</td> <td>012345678</td> <td>:01234:</td> <td>01234</td> </tr> <tr> <td>2</td> <td>01</td> <td>01</td> <td>01</td> <td>01234567890</td> <td>01234567890</td> <td>012345678</td> <td>:01234:</td> <td>01234</td> </tr> <tr> <td>3</td> <td>01</td> <td>01</td> <td>01</td> <td>01234567890</td> <td>01234567890</td> <td>012345678</td> <td>:01234:</td> <td>01234</td> </tr> <tr> <td>4</td> <td>01</td> <td>01</td> <td>01</td> <td>01234567890</td> <td>01234567890</td> <td>012345678</td> <td>:01234:</td> <td>01234</td> </tr> <tr> <td>5</td> <td>01</td> <td>01</td> <td>01</td> <td>01234567890</td> <td>01234567890</td> <td>012345678</td> <td>:01234:</td> <td>01234</td> </tr> </tbody> </table>	No.	Pat	Me	thod	Address	Arc Address	Speed	Dwell Time	M Code	1	01	01	01	01234567890	01234567890	012345678	:01234:	01234	2	01	01	01	01234567890	01234567890	012345678	:01234:	01234	3	01	01	01	01234567890	01234567890	012345678	:01234:	01234	4	01	01	01	01234567890	01234567890	012345678	:01234:	01234	5	01	01	01	01234567890	01234567890	012345678	:01234:	01234	1)	1300	0514	2300	08FC	3300	0CE4																																		
	No.	Pat	Me	thod	Address	Arc Address	Speed	Dwell Time	M Code																																																																																						
	1	01	01	01	01234567890	01234567890	012345678	:01234:	01234																																																																																						
	2	01	01	01	01234567890	01234567890	012345678	:01234:	01234																																																																																						
3	01	01	01	01234567890	01234567890	012345678	:01234:	01234																																																																																							
4	01	01	01	01234567890	01234567890	012345678	:01234:	01234																																																																																							
5	01	01	01	01234567890	01234567890	012345678	:01234:	01234																																																																																							
	2)	to	to	to	to	to	to																																																																																								
	3)	2299	08FB	3299	0CE3	4299	10CB																																																																																								

12.24 AJ71PT32-S3,A1SJ71PT32-S3 Module Monitor

Screen Image		No.	Buffer memory address																																																				
			dec.	hex.																																																			
<p>AJ71PT32-S3 I/O Monitor Scr. (I/O Dedicated Mode)</p> <table border="1"> <thead> <tr> <th>Inputs (X)</th> <th>Outputs (Y)</th> </tr> </thead> <tbody> <tr><td>00 Hardware Fault</td><td>10</td></tr> <tr><td>01 Link Working</td><td>01</td></tr> <tr><td>02</td><td>12</td></tr> <tr><td>03</td><td>03</td></tr> <tr><td>04</td><td>14</td></tr> <tr><td>05 Test Mode</td><td>05</td></tr> <tr><td>06 Link Error Detect</td><td>06</td></tr> <tr><td>07 Link Comms. Error</td><td>07</td></tr> <tr><td>08</td><td>08</td></tr> <tr><td>09</td><td>09</td></tr> <tr><td>0A</td><td>0A</td></tr> <tr><td>0B</td><td>0B</td></tr> <tr><td>0C</td><td>0C</td></tr> <tr><td>0D</td><td>0D</td></tr> <tr><td>0E</td><td>0E</td></tr> <tr><td>0F</td><td>0F</td></tr> </tbody> </table>		Inputs (X)	Outputs (Y)	00 Hardware Fault	10	01 Link Working	01	02	12	03	03	04	14	05 Test Mode	05	06 Link Error Detect	06	07 Link Comms. Error	07	08	08	09	09	0A	0A	0B	0B	0C	0C	0D	0D	0E	0E	0F	0F	1)	---	---																	
Inputs (X)	Outputs (Y)																																																						
00 Hardware Fault	10																																																						
01 Link Working	01																																																						
02	12																																																						
03	03																																																						
04	14																																																						
05 Test Mode	05																																																						
06 Link Error Detect	06																																																						
07 Link Comms. Error	07																																																						
08	08																																																						
09	09																																																						
0A	0A																																																						
0B	0B																																																						
0C	0C																																																						
0D	0D																																																						
0E	0E																																																						
0F	0F																																																						
<p>AJ71PT32-S3 Link Data Monitor Screen</p> <table border="1"> <thead> <tr> <th>No. of Remote Stations</th> <th>Communication Error Code</th> </tr> </thead> <tbody> <tr><td>01</td><td>01</td></tr> <tr><td>02</td><td>02</td></tr> <tr><td>03</td><td>03</td></tr> <tr><td>04</td><td>04</td></tr> <tr><td>05</td><td>05</td></tr> <tr><td>06</td><td>06</td></tr> <tr><td>07</td><td>07</td></tr> <tr><td>08</td><td>08</td></tr> <tr><td>09</td><td>09</td></tr> <tr><td>0A</td><td>0A</td></tr> <tr><td>0B</td><td>0B</td></tr> <tr><td>0C</td><td>0C</td></tr> <tr><td>0D</td><td>0D</td></tr> <tr><td>0E</td><td>0E</td></tr> <tr><td>0F</td><td>0F</td></tr> </tbody> </table>		No. of Remote Stations	Communication Error Code	01	01	02	02	03	03	04	04	05	05	06	06	07	07	08	08	09	09	0A	0A	0B	0B	0C	0C	0D	0D	0E	0E	0F	0F	1)	0	0000																			
No. of Remote Stations	Communication Error Code																																																						
01	01																																																						
02	02																																																						
03	03																																																						
04	04																																																						
05	05																																																						
06	06																																																						
07	07																																																						
08	08																																																						
09	09																																																						
0A	0A																																																						
0B	0B																																																						
0C	0C																																																						
0D	0D																																																						
0E	0E																																																						
0F	0F																																																						
		2)	70 to 77	0046 to 004D																																																			
		3)	195	00C3																																																			
		4)	107	006B																																																			
		5)	90 to 93	005A to 005D																																																			
		6)	100 to 103	0064 to 0067																																																			
		7)	598	0256																																																			
		8)	599	0257																																																			
<p>AJ71PT32-S3 Batch Refresh Data Monitor Screen</p> <table border="1"> <thead> <tr> <th>Station Number</th> <th>Transmission Data</th> <th>Receive Data</th> </tr> </thead> <tbody> <tr><td>4-1</td><td>0110110101101101101101101101101</td><td>0110110101101101101101101101101</td></tr> <tr><td>8-5</td><td>0110110101101101101101101101101</td><td>0110110101101101101101101101101</td></tr> <tr><td>12-9</td><td>0110110101101101101101101101101</td><td>0110110101101101101101101101101</td></tr> <tr><td>16-13</td><td>0110110101101101101101101101101</td><td>0110110101101101101101101101101</td></tr> <tr><td>20-17</td><td>0110110101101101101101101101101</td><td>0110110101101101101101101101101</td></tr> <tr><td>24-21</td><td>0110110101101101101101101101101</td><td>0110110101101101101101101101101</td></tr> <tr><td>28-25</td><td>0110110101101101101101101101101</td><td>0110110101101101101101101101101</td></tr> <tr><td>32-29</td><td>0110110101101101101101101101101</td><td>0110110101101101101101101101101</td></tr> <tr><td>36-33</td><td>0110110101101101101101101101101</td><td>0110110101101101101101101101101</td></tr> <tr><td>40-37</td><td>0110110101101101101101101101101</td><td>0110110101101101101101101101101</td></tr> <tr><td>44-41</td><td>0110110101101101101101101101101</td><td>0110110101101101101101101101101</td></tr> <tr><td>48-45</td><td>0110110101101101101101101101101</td><td>0110110101101101101101101101101</td></tr> <tr><td>52-49</td><td>0110110101101101101101101101101</td><td>0110110101101101101101101101101</td></tr> <tr><td>56-53</td><td>0110110101101101101101101101101</td><td>0110110101101101101101101101101</td></tr> <tr><td>60-57</td><td>0110110101101101101101101101101</td><td>0110110101101101101101101101101</td></tr> <tr><td>64-61</td><td>0110110101101101101101101101101</td><td>0110110101101101101101101101101</td></tr> </tbody> </table>		Station Number	Transmission Data	Receive Data	4-1	0110110101101101101101101101101	0110110101101101101101101101101	8-5	0110110101101101101101101101101	0110110101101101101101101101101	12-9	0110110101101101101101101101101	0110110101101101101101101101101	16-13	0110110101101101101101101101101	0110110101101101101101101101101	20-17	0110110101101101101101101101101	0110110101101101101101101101101	24-21	0110110101101101101101101101101	0110110101101101101101101101101	28-25	0110110101101101101101101101101	0110110101101101101101101101101	32-29	0110110101101101101101101101101	0110110101101101101101101101101	36-33	0110110101101101101101101101101	0110110101101101101101101101101	40-37	0110110101101101101101101101101	0110110101101101101101101101101	44-41	0110110101101101101101101101101	0110110101101101101101101101101	48-45	0110110101101101101101101101101	0110110101101101101101101101101	52-49	0110110101101101101101101101101	0110110101101101101101101101101	56-53	0110110101101101101101101101101	0110110101101101101101101101101	60-57	0110110101101101101101101101101	0110110101101101101101101101101	64-61	0110110101101101101101101101101	0110110101101101101101101101101	1)	10 to 41	000A to 0029
Station Number	Transmission Data	Receive Data																																																					
4-1	0110110101101101101101101101101	0110110101101101101101101101101																																																					
8-5	0110110101101101101101101101101	0110110101101101101101101101101																																																					
12-9	0110110101101101101101101101101	0110110101101101101101101101101																																																					
16-13	0110110101101101101101101101101	0110110101101101101101101101101																																																					
20-17	0110110101101101101101101101101	0110110101101101101101101101101																																																					
24-21	0110110101101101101101101101101	0110110101101101101101101101101																																																					
28-25	0110110101101101101101101101101	0110110101101101101101101101101																																																					
32-29	0110110101101101101101101101101	0110110101101101101101101101101																																																					
36-33	0110110101101101101101101101101	0110110101101101101101101101101																																																					
40-37	0110110101101101101101101101101	0110110101101101101101101101101																																																					
44-41	0110110101101101101101101101101	0110110101101101101101101101101																																																					
48-45	0110110101101101101101101101101	0110110101101101101101101101101																																																					
52-49	0110110101101101101101101101101	0110110101101101101101101101101																																																					
56-53	0110110101101101101101101101101	0110110101101101101101101101101																																																					
60-57	0110110101101101101101101101101	0110110101101101101101101101101																																																					
64-61	0110110101101101101101101101101	0110110101101101101101101101101																																																					
		2)	110 to 141	006E to 008D																																																			

12.25 AJ71ID1(ID2) -R4,A1SJ71ID1(ID2) -R4 Module Monitor

Screen Image		No.	Buffer memory address																																																																																																																																											
			X		Y																																																																																																																																									
			dec.	hex.	dec.	hex.																																																																																																																																								
<p>AJ71ID Movement Monitor Screen CH1</p> <table border="1"> <thead> <tr> <th>Addr</th> <th>Data</th> <th>Addr</th> <th>Data</th> <th>Addr</th> <th>Data</th> <th>Addr</th> <th>Data</th> </tr> </thead> <tbody> <tr><td>K 100</td><td>H 0123</td><td>K 116</td><td>H 0123</td><td>K 132</td><td>H 0123</td><td>K 148</td><td>H 0123</td></tr> <tr><td>K 101</td><td>H 0123</td><td>K 117</td><td>H 0123</td><td>K 133</td><td>H 0123</td><td>K 149</td><td>H 0123</td></tr> <tr><td>K 102</td><td>H 0123</td><td>K 118</td><td>H 0123</td><td>K 134</td><td>H 0123</td><td>K 150</td><td>H 0123</td></tr> <tr><td>K 103</td><td>H 0123</td><td>K 119</td><td>H 0123</td><td>K 135</td><td>H 0123</td><td>K 151</td><td>H 0123</td></tr> <tr><td>K 104</td><td>H 0123</td><td>K 120</td><td>H 0123</td><td>K 136</td><td>H 0123</td><td>K 152</td><td>H 0123</td></tr> <tr><td>K 105</td><td>H 0123</td><td>K 121</td><td>H 0123</td><td>K 137</td><td>H 0123</td><td>K 153</td><td>H 0123</td></tr> <tr><td>K 106</td><td>H 0123</td><td>K 122</td><td>H 0123</td><td>K 138</td><td>H 0123</td><td>K 154</td><td>H 0123</td></tr> <tr><td>K 107</td><td>H 0123</td><td>K 123</td><td>H 0123</td><td>K 139</td><td>H 0123</td><td>K 155</td><td>H 0123</td></tr> <tr><td>K 108</td><td>H 0123</td><td>K 124</td><td>H 0123</td><td>K 140</td><td>H 0123</td><td>K 156</td><td>H 0123</td></tr> <tr><td>K 109</td><td>H 0123</td><td>K 125</td><td>H 0123</td><td>K 141</td><td>H 0123</td><td>K 157</td><td>H 0123</td></tr> <tr><td>K 110</td><td>H 0123</td><td>K 126</td><td>H 0123</td><td>K 142</td><td>H 0123</td><td>K 158</td><td>H 0123</td></tr> <tr><td>K 111</td><td>H 0123</td><td>K 127</td><td>H 0123</td><td>K 143</td><td>H 0123</td><td>K 159</td><td>H 0123</td></tr> <tr><td>K 112</td><td>H 0123</td><td>K 128</td><td>H 0123</td><td>K 144</td><td>H 0123</td><td>K 160</td><td>H 0123</td></tr> <tr><td>K 113</td><td>H 0123</td><td>K 129</td><td>H 0123</td><td>K 145</td><td>H 0123</td><td>K 161</td><td>H 0123</td></tr> <tr><td>K 114</td><td>H 0123</td><td>K 130</td><td>H 0123</td><td>K 146</td><td>H 0123</td><td>K 162</td><td>H 0123</td></tr> <tr><td>K 115</td><td>H 0123</td><td>K 131</td><td>H 0123</td><td>K 147</td><td>H 0123</td><td>K 163</td><td>H 0123</td></tr> </tbody> </table>		Addr	Data	Addr	Data	Addr	Data	Addr	Data	K 100	H 0123	K 116	H 0123	K 132	H 0123	K 148	H 0123	K 101	H 0123	K 117	H 0123	K 133	H 0123	K 149	H 0123	K 102	H 0123	K 118	H 0123	K 134	H 0123	K 150	H 0123	K 103	H 0123	K 119	H 0123	K 135	H 0123	K 151	H 0123	K 104	H 0123	K 120	H 0123	K 136	H 0123	K 152	H 0123	K 105	H 0123	K 121	H 0123	K 137	H 0123	K 153	H 0123	K 106	H 0123	K 122	H 0123	K 138	H 0123	K 154	H 0123	K 107	H 0123	K 123	H 0123	K 139	H 0123	K 155	H 0123	K 108	H 0123	K 124	H 0123	K 140	H 0123	K 156	H 0123	K 109	H 0123	K 125	H 0123	K 141	H 0123	K 157	H 0123	K 110	H 0123	K 126	H 0123	K 142	H 0123	K 158	H 0123	K 111	H 0123	K 127	H 0123	K 143	H 0123	K 159	H 0123	K 112	H 0123	K 128	H 0123	K 144	H 0123	K 160	H 0123	K 113	H 0123	K 129	H 0123	K 145	H 0123	K 161	H 0123	K 114	H 0123	K 130	H 0123	K 146	H 0123	K 162	H 0123	K 115	H 0123	K 131	H 0123	K 147	H 0123	K 163	H 0123	1)	100 to 163	0064 to 00A3	4100 to 4163	1004 to 1043
Addr	Data	Addr	Data	Addr	Data	Addr	Data																																																																																																																																							
K 100	H 0123	K 116	H 0123	K 132	H 0123	K 148	H 0123																																																																																																																																							
K 101	H 0123	K 117	H 0123	K 133	H 0123	K 149	H 0123																																																																																																																																							
K 102	H 0123	K 118	H 0123	K 134	H 0123	K 150	H 0123																																																																																																																																							
K 103	H 0123	K 119	H 0123	K 135	H 0123	K 151	H 0123																																																																																																																																							
K 104	H 0123	K 120	H 0123	K 136	H 0123	K 152	H 0123																																																																																																																																							
K 105	H 0123	K 121	H 0123	K 137	H 0123	K 153	H 0123																																																																																																																																							
K 106	H 0123	K 122	H 0123	K 138	H 0123	K 154	H 0123																																																																																																																																							
K 107	H 0123	K 123	H 0123	K 139	H 0123	K 155	H 0123																																																																																																																																							
K 108	H 0123	K 124	H 0123	K 140	H 0123	K 156	H 0123																																																																																																																																							
K 109	H 0123	K 125	H 0123	K 141	H 0123	K 157	H 0123																																																																																																																																							
K 110	H 0123	K 126	H 0123	K 142	H 0123	K 158	H 0123																																																																																																																																							
K 111	H 0123	K 127	H 0123	K 143	H 0123	K 159	H 0123																																																																																																																																							
K 112	H 0123	K 128	H 0123	K 144	H 0123	K 160	H 0123																																																																																																																																							
K 113	H 0123	K 129	H 0123	K 145	H 0123	K 161	H 0123																																																																																																																																							
K 114	H 0123	K 130	H 0123	K 146	H 0123	K 162	H 0123																																																																																																																																							
K 115	H 0123	K 131	H 0123	K 147	H 0123	K 163	H 0123																																																																																																																																							
<p>AJ71ID Input/Output Monitor Screen</p> <table border="1"> <thead> <tr> <th></th> <th>X</th> <th>Y</th> </tr> </thead> <tbody> <tr><td>00</td><td>WDT Error</td><td>10</td></tr> <tr><td>01</td><td></td><td>11</td></tr> <tr><td>02</td><td></td><td>12</td></tr> <tr><td>03</td><td>CH1 ID-BUSY</td><td>13</td></tr> <tr><td>04</td><td>ID-CommandComplete</td><td>14</td></tr> <tr><td>05</td><td>ID-Error</td><td>15</td></tr> <tr><td>06</td><td>ID-READY</td><td>16</td></tr> <tr><td>07</td><td></td><td>17</td></tr> <tr><td>08</td><td></td><td>18</td></tr> <tr><td>09</td><td></td><td>19</td></tr> <tr><td>0A</td><td></td><td>1A</td></tr> <tr><td>0B</td><td>CH2 ID-BUSY</td><td>1B</td></tr> <tr><td>0C</td><td>ID-CommandComplete</td><td>1C</td></tr> <tr><td>0D</td><td>ID-Error</td><td>1D</td></tr> <tr><td>0E</td><td></td><td>1E</td></tr> <tr><td>0F</td><td></td><td>1F</td></tr> </tbody> </table>			X	Y	00	WDT Error	10	01		11	02		12	03	CH1 ID-BUSY	13	04	ID-CommandComplete	14	05	ID-Error	15	06	ID-READY	16	07		17	08		18	09		19	0A		1A	0B	CH2 ID-BUSY	1B	0C	ID-CommandComplete	1C	0D	ID-Error	1D	0E		1E	0F		1F	1)	---	---	---	---																																																																																					
	X	Y																																																																																																																																												
00	WDT Error	10																																																																																																																																												
01		11																																																																																																																																												
02		12																																																																																																																																												
03	CH1 ID-BUSY	13																																																																																																																																												
04	ID-CommandComplete	14																																																																																																																																												
05	ID-Error	15																																																																																																																																												
06	ID-READY	16																																																																																																																																												
07		17																																																																																																																																												
08		18																																																																																																																																												
09		19																																																																																																																																												
0A		1A																																																																																																																																												
0B	CH2 ID-BUSY	1B																																																																																																																																												
0C	ID-CommandComplete	1C																																																																																																																																												
0D	ID-Error	1D																																																																																																																																												
0E		1E																																																																																																																																												
0F		1F																																																																																																																																												
<p>AJ71ID Set Up Information Monitor Screen</p> <table border="1"> <thead> <tr> <th></th> <th>Valid range</th> <th>CH1</th> <th>CH2</th> </tr> </thead> <tbody> <tr> <td>1)</td> <td>ID Command</td> <td>Continual Write</td> <td>Comparison Write</td> </tr> <tr> <td>2)</td> <td>Address, Data</td> <td>0~4094 · 1~3900</td> <td>K 0123 · K 0123Word</td> </tr> <tr> <td>3)</td> <td>Retry</td> <td>0~32767</td> <td>01234 01234</td> </tr> <tr> <td>4)</td> <td>Total Communica.</td> <td>0123456789</td> <td>0123456789</td> </tr> <tr> <td>5)</td> <td>Comparison</td> <td><input type="checkbox"/> Disagreement <input type="checkbox"/> OFF</td> <td><input type="checkbox"/> Disagreement <input type="checkbox"/> OFF</td> </tr> <tr> <td>6)</td> <td>Copy direction</td> <td>12: CH1 → CH2 21: ←</td> <td>CH1 → CH2</td> </tr> <tr> <td>7)</td> <td>LED Status</td> <td><input type="checkbox"/> DC24V <input type="checkbox"/> IDERR <input type="checkbox"/> ERR</td> <td><input type="checkbox"/> DC24V <input type="checkbox"/> IDERR <input type="checkbox"/> ERR</td> </tr> <tr> <td>8)</td> <td>Err Record Latst</td> <td>Execution Word Number Error Execution Address Error Write Incompletion Error Set Up Address Error Set Up Word Number Error</td> <td>Data Career Absent Error Data Career Communicate Error Command Execution Error Command Code Error Communicate Condition Error</td> </tr> </tbody> </table>			Valid range	CH1	CH2	1)	ID Command	Continual Write	Comparison Write	2)	Address, Data	0~4094 · 1~3900	K 0123 · K 0123Word	3)	Retry	0~32767	01234 01234	4)	Total Communica.	0123456789	0123456789	5)	Comparison	<input type="checkbox"/> Disagreement <input type="checkbox"/> OFF	<input type="checkbox"/> Disagreement <input type="checkbox"/> OFF	6)	Copy direction	12: CH1 → CH2 21: ←	CH1 → CH2	7)	LED Status	<input type="checkbox"/> DC24V <input type="checkbox"/> IDERR <input type="checkbox"/> ERR	<input type="checkbox"/> DC24V <input type="checkbox"/> IDERR <input type="checkbox"/> ERR	8)	Err Record Latst	Execution Word Number Error Execution Address Error Write Incompletion Error Set Up Address Error Set Up Word Number Error	Data Career Absent Error Data Career Communicate Error Command Execution Error Command Code Error Communicate Condition Error	1)	0	0000	4000	0FA0																																																																																																				
	Valid range	CH1	CH2																																																																																																																																											
1)	ID Command	Continual Write	Comparison Write																																																																																																																																											
2)	Address, Data	0~4094 · 1~3900	K 0123 · K 0123Word																																																																																																																																											
3)	Retry	0~32767	01234 01234																																																																																																																																											
4)	Total Communica.	0123456789	0123456789																																																																																																																																											
5)	Comparison	<input type="checkbox"/> Disagreement <input type="checkbox"/> OFF	<input type="checkbox"/> Disagreement <input type="checkbox"/> OFF																																																																																																																																											
6)	Copy direction	12: CH1 → CH2 21: ←	CH1 → CH2																																																																																																																																											
7)	LED Status	<input type="checkbox"/> DC24V <input type="checkbox"/> IDERR <input type="checkbox"/> ERR	<input type="checkbox"/> DC24V <input type="checkbox"/> IDERR <input type="checkbox"/> ERR																																																																																																																																											
8)	Err Record Latst	Execution Word Number Error Execution Address Error Write Incompletion Error Set Up Address Error Set Up Word Number Error	Data Career Absent Error Data Career Communicate Error Command Execution Error Command Code Error Communicate Condition Error																																																																																																																																											
		2)	1	0001	4001	0FA1																																																																																																																																								
		3)	2	0002	4002	0FA2																																																																																																																																								
		4)	8	0008	4008	0FA8																																																																																																																																								
		4)	22	0016	4022	0FB6																																																																																																																																								
		4)	23	0017	4023	0FB7																																																																																																																																								
		5)	4	0004	4004	0FA4																																																																																																																																								
		5)	5	0005	4005	0FA5																																																																																																																																								
		6)	---	---	4010	0FAA																																																																																																																																								
		7)	12	000C	4012	0FAC																																																																																																																																								
		8)	14 to 18	000E to 0012	4014 to 4018	0FAE to 0FB2																																																																																																																																								
		---	---	---	---	---																																																																																																																																								

12.26 A84AD Module Monitor

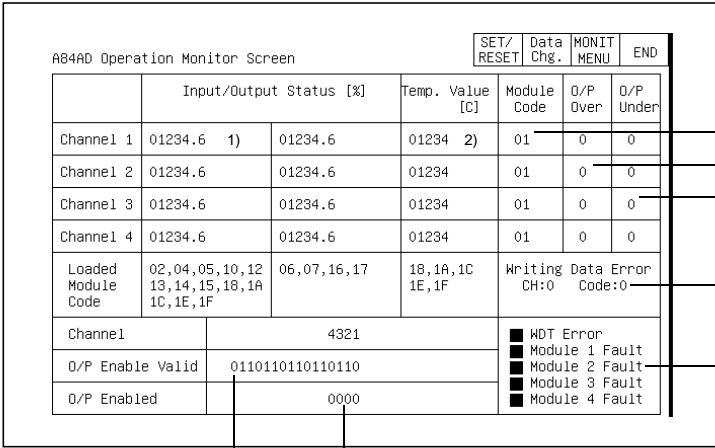
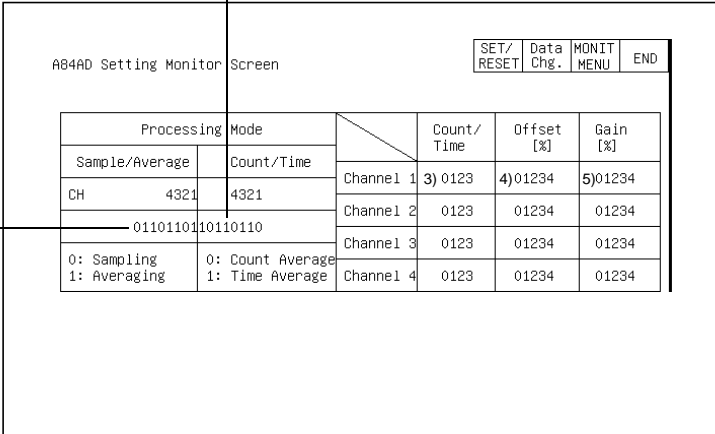
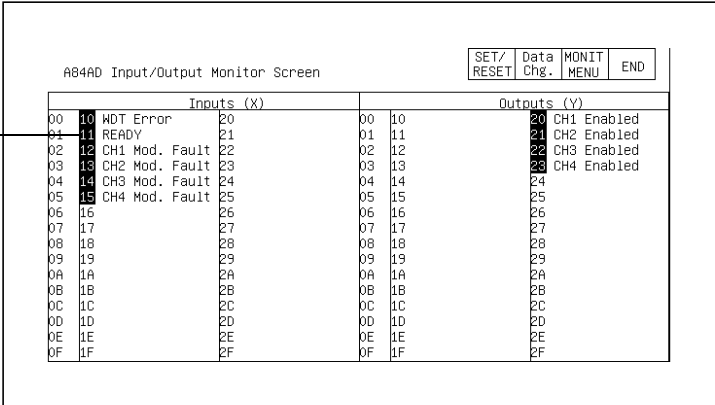
Screen Image	No.	Buffer memory address																																																																							
		dec.	hex.																																																																						
 <p>A84AD Operation Monitor Screen</p> <p>Input/Output Status [%]</p> <table border="1"> <thead> <tr> <th>Channel</th> <th>Input</th> <th>Output</th> <th>Temp. Value [C]</th> <th>Module Code</th> <th>O/P Over</th> <th>O/P Under</th> </tr> </thead> <tbody> <tr> <td>Channel 1</td> <td>01234.6</td> <td>01234.6</td> <td>01234</td> <td>01</td> <td>0</td> <td>0</td> </tr> <tr> <td>Channel 2</td> <td>01234.6</td> <td>01234.6</td> <td>01234</td> <td>01</td> <td>0</td> <td>0</td> </tr> <tr> <td>Channel 3</td> <td>01234.6</td> <td>01234.6</td> <td>01234</td> <td>01</td> <td>0</td> <td>0</td> </tr> <tr> <td>Channel 4</td> <td>01234.6</td> <td>01234.6</td> <td>01234</td> <td>01</td> <td>0</td> <td>0</td> </tr> </tbody> </table> <p>Loaded Module Code: 02,04,05,10,12,13,14,15,18,1A,1C,1E,1F</p> <p>Temp. Value [C]: 06,07,16,17</p> <p>Module Code: 18,1A,1C,1E,1F</p> <p>Writing Data Error CH:0 Code:0</p> <p>Channel: 4321</p> <p>O/P Enable Valid: 0110110110110110</p> <p>O/P Enabled: 0000</p> <p>Legend: ■ WDT Error ■ Module 1 Fault ■ Module 2 Fault ■ Module 3 Fault ■ Module 4 Fault </p>	Channel	Input	Output	Temp. Value [C]	Module Code	O/P Over	O/P Under	Channel 1	01234.6	01234.6	01234	01	0	0	Channel 2	01234.6	01234.6	01234	01	0	0	Channel 3	01234.6	01234.6	01234	01	0	0	Channel 4	01234.6	01234.6	01234	01	0	0	1)	10 to 13	000A to 000D																																			
	Channel	Input	Output	Temp. Value [C]	Module Code	O/P Over	O/P Under																																																																		
	Channel 1	01234.6	01234.6	01234	01	0	0																																																																		
	Channel 2	01234.6	01234.6	01234	01	0	0																																																																		
	Channel 3	01234.6	01234.6	01234	01	0	0																																																																		
	Channel 4	01234.6	01234.6	01234	01	0	0																																																																		
	2)	18 to 21	0012 to 0015																																																																						
	3)	28 to 31	001C to 001F																																																																						
	4)	22 to 25	0016 to 0019																																																																						
5)	22 to 25	0016 to 0019																																																																							
6)	26	001A																																																																							
7)	27	001B																																																																							
8)	---	---																																																																							
9)	---	---																																																																							
 <p>A84AD Setting Monitor Screen</p> <p>Processing Mode</p> <table border="1"> <thead> <tr> <th>Sample/Average</th> <th>Count/Time</th> <th>Count/Time</th> <th>Offset [%]</th> <th>Gain [%]</th> </tr> </thead> <tbody> <tr> <td>CH 4321</td> <td>4321</td> <td>0110110110110110</td> <td>01234</td> <td>01234</td> </tr> <tr> <td>0: Sampling</td> <td>0: Count Average</td> <td>01234</td> <td>01234</td> <td>01234</td> </tr> <tr> <td>1: Averaging</td> <td>1: Time Average</td> <td>01234</td> <td>01234</td> <td>01234</td> </tr> </tbody> </table>	Sample/Average	Count/Time	Count/Time	Offset [%]	Gain [%]	CH 4321	4321	0110110110110110	01234	01234	0: Sampling	0: Count Average	01234	01234	01234	1: Averaging	1: Time Average	01234	01234	01234	1)	1	0001																																																		
	Sample/Average	Count/Time	Count/Time	Offset [%]	Gain [%]																																																																				
	CH 4321	4321	0110110110110110	01234	01234																																																																				
	0: Sampling	0: Count Average	01234	01234	01234																																																																				
	1: Averaging	1: Time Average	01234	01234	01234																																																																				
2)	1	0001																																																																							
3)	2 to 5	0002 to 0005																																																																							
4)	32, 34, 36, 38	0020, 0022, 0024, 0026																																																																							
5)	33, 35, 37, 39	0021, 0023, 0025, 0027																																																																							
 <p>A84AD Input/Output Monitor Screen</p> <table border="1"> <thead> <tr> <th colspan="3">Inputs (X)</th> <th colspan="3">Outputs (Y)</th> </tr> </thead> <tbody> <tr> <td>00 10 WDT Error</td> <td>20 10</td> <td>20 10</td> <td>20 CH1 Enabled</td> </tr> <tr> <td>01 11 READY</td> <td>21 11</td> <td>21 11</td> <td>21 CH2 Enabled</td> </tr> <tr> <td>02 12 CH1 Mod. Fault</td> <td>22 12</td> <td>22 12</td> <td>22 CH3 Enabled</td> </tr> <tr> <td>03 13 CH2 Mod. Fault</td> <td>23 13</td> <td>23 13</td> <td>23 CH4 Enabled</td> </tr> <tr> <td>04 14 CH3 Mod. Fault</td> <td>24 14</td> <td>24 14</td> <td>24</td> </tr> <tr> <td>05 15 CH4 Mod. Fault</td> <td>25 15</td> <td>25 15</td> <td>25</td> </tr> <tr> <td>06 16</td> <td>26 16</td> <td>26 16</td> <td>26</td> </tr> <tr> <td>07 17</td> <td>27 17</td> <td>27 17</td> <td>27</td> </tr> <tr> <td>08 18</td> <td>28 18</td> <td>28 18</td> <td>28</td> </tr> <tr> <td>09 19</td> <td>29 19</td> <td>29 19</td> <td>29</td> </tr> <tr> <td>0A 1A</td> <td>2A 1A</td> <td>2A 1A</td> <td>2A</td> </tr> <tr> <td>0B 1B</td> <td>2B 1B</td> <td>2B 1B</td> <td>2B</td> </tr> <tr> <td>0C 1C</td> <td>2C 1C</td> <td>2C 1C</td> <td>2C</td> </tr> <tr> <td>0D 1D</td> <td>2D 1D</td> <td>2D 1D</td> <td>2D</td> </tr> <tr> <td>0E 1E</td> <td>2E 1E</td> <td>2E 1E</td> <td>2E</td> </tr> <tr> <td>0F 1F</td> <td>2F 1F</td> <td>2F 1F</td> <td>2F</td> </tr> </tbody> </table>	Inputs (X)			Outputs (Y)			00 10 WDT Error	20 10	20 10	20 CH1 Enabled	01 11 READY	21 11	21 11	21 CH2 Enabled	02 12 CH1 Mod. Fault	22 12	22 12	22 CH3 Enabled	03 13 CH2 Mod. Fault	23 13	23 13	23 CH4 Enabled	04 14 CH3 Mod. Fault	24 14	24 14	24	05 15 CH4 Mod. Fault	25 15	25 15	25	06 16	26 16	26 16	26	07 17	27 17	27 17	27	08 18	28 18	28 18	28	09 19	29 19	29 19	29	0A 1A	2A 1A	2A 1A	2A	0B 1B	2B 1B	2B 1B	2B	0C 1C	2C 1C	2C 1C	2C	0D 1D	2D 1D	2D 1D	2D	0E 1E	2E 1E	2E 1E	2E	0F 1F	2F 1F	2F 1F	2F	1)	---	---
Inputs (X)			Outputs (Y)																																																																						
00 10 WDT Error	20 10	20 10	20 CH1 Enabled																																																																						
01 11 READY	21 11	21 11	21 CH2 Enabled																																																																						
02 12 CH1 Mod. Fault	22 12	22 12	22 CH3 Enabled																																																																						
03 13 CH2 Mod. Fault	23 13	23 13	23 CH4 Enabled																																																																						
04 14 CH3 Mod. Fault	24 14	24 14	24																																																																						
05 15 CH4 Mod. Fault	25 15	25 15	25																																																																						
06 16	26 16	26 16	26																																																																						
07 17	27 17	27 17	27																																																																						
08 18	28 18	28 18	28																																																																						
09 19	29 19	29 19	29																																																																						
0A 1A	2A 1A	2A 1A	2A																																																																						
0B 1B	2B 1B	2B 1B	2B																																																																						
0C 1C	2C 1C	2C 1C	2C																																																																						
0D 1D	2D 1D	2D 1D	2D																																																																						
0E 1E	2E 1E	2E 1E	2E																																																																						
0F 1F	2F 1F	2F 1F	2F																																																																						

Screen Image	No.	Buffer memory address	
		dec.	hex.
<p>A84AD Graph Monitor Screen</p> <p>Input/Output [%] 0 50 100 75 100</p> <p>Channel 1, Channel 2, Channel 3, Channel 4</p> <p>Temp. Value [C] 01234</p> <p>Module Code 01</p> <p>Top Scale (0): For module codes 06, 07, 16 & 17. Bottom Scale (0): For all other module codes.</p> <p>Channel 4321</p> <p>O/P Enable Valid 0110110110110110</p> <p>O/P Enabled 0000</p> <p>0: Effective 1: Invalidity</p> <p>Legend: WDT Error, Module 1 Fault, Module 2 Fault, Module 3 Fault, Module 4 Fault</p>	1)	10 to 13	000A to 000D
	2)	18 to 21	0012 to 0015
	3)	28 to 31	001C to 001F
	4)	27	001B
	5)	---	---

12.27 A1S64TCTT(BW)-S1, A1S64TCRT(BW)-S1 Module Monitor

Screen Image	No.	Buffer memory address																																																																
		CH1		CH2		CH3		CH4																																																										
		dec.	hex.	dec.	hex.	dec.	hex.	dec.	hex.																																																									
<p>A1S64TCTT/RT-S1 Operation Monitor Screen (ALL CH)</p> <table border="1"> <thead> <tr> <th></th> <th>CH1</th> <th>CH2</th> <th>CH3</th> <th>CH4</th> </tr> </thead> <tbody> <tr> <td>1) Input range</td> <td>R</td> <td>Wre5-26</td> <td>J</td> <td>JPt100</td> </tr> <tr> <td>2) Measurement unit</td> <td>°C</td> <td>°F</td> <td>°F</td> <td>°C</td> </tr> <tr> <td>3) Decimal point position</td> <td>0</td> <td>0</td> <td>0</td> <td>0</td> </tr> <tr> <td rowspan="2">4) Temp. process value (PV)</td> <td>Decimal point =0</td> <td>012345</td> <td>012345</td> <td>012345</td> <td>012345</td> </tr> <tr> <td>Decimal point =1</td> <td>0123.5</td> <td>0123.5</td> <td>0123.5</td> <td>0123.5</td> </tr> <tr> <td rowspan="2">5) Set value setting (SV)</td> <td>Decimal point =0</td> <td>012345</td> <td>012345</td> <td>012345</td> <td>012345</td> </tr> <tr> <td>Decimal point =1</td> <td>0123.5</td> <td>0123.5</td> <td>0123.5</td> <td>0123.5</td> </tr> <tr> <td>6) Manipulation value (MV) [%]</td> <td>0-100</td> <td>0-100</td> <td>0-100</td> <td>0-100</td> </tr> <tr> <td>7) Alert occurrence flag</td> <td>■</td> <td>■</td> <td>■</td> <td>■</td> </tr> <tr> <td>8) Write error flag</td> <td></td> <td>■</td> <td></td> <td></td> </tr> </tbody> </table>		CH1	CH2	CH3	CH4	1) Input range	R	Wre5-26	J	JPt100	2) Measurement unit	°C	°F	°F	°C	3) Decimal point position	0	0	0	0	4) Temp. process value (PV)	Decimal point =0	012345	012345	012345	012345	Decimal point =1	0123.5	0123.5	0123.5	0123.5	5) Set value setting (SV)	Decimal point =0	012345	012345	012345	012345	Decimal point =1	0123.5	0123.5	0123.5	0123.5	6) Manipulation value (MV) [%]	0-100	0-100	0-100	0-100	7) Alert occurrence flag	■	■	■	■	8) Write error flag		■			1)	32	0020	64	0040	96	0060	128	0080
		CH1	CH2	CH3	CH4																																																													
	1) Input range	R	Wre5-26	J	JPt100																																																													
	2) Measurement unit	°C	°F	°F	°C																																																													
	3) Decimal point position	0	0	0	0																																																													
	4) Temp. process value (PV)	Decimal point =0	012345	012345	012345	012345																																																												
		Decimal point =1	0123.5	0123.5	0123.5	0123.5																																																												
	5) Set value setting (SV)	Decimal point =0	012345	012345	012345	012345																																																												
Decimal point =1		0123.5	0123.5	0123.5	0123.5																																																													
6) Manipulation value (MV) [%]	0-100	0-100	0-100	0-100																																																														
7) Alert occurrence flag	■	■	■	■																																																														
8) Write error flag		■																																																																
2)	32	0020	64	0040	96	0060	128	0080																																																										
3)	1	0001	2	0002	3	0003	4	0004																																																										
4)	9	0009	10	000A	11	000B	12	000C																																																										
5)	34	0022	66	0042	98	0062	130	0082																																																										
6)	13	000D	14	000E	15	000F	16	0010																																																										
7)	---	---	---	---	---	---	---	---																																																										
8)	---	---	---	---	---	---	---	---																																																										
<p>A1S64TCTT/RT-S1 Alert details</p> <table border="1"> <thead> <tr> <th></th> <th>CH1</th> <th>CH2</th> <th>CH3</th> <th>CH4</th> </tr> </thead> <tbody> <tr> <td>PV exceeds the specified temperature measurement range in the input range.</td> <td>■</td> <td>■</td> <td>□</td> <td>■</td> </tr> <tr> <td>PV is below the specified temperature measurement range in the input range.</td> <td>□</td> <td>■</td> <td>■</td> <td>■</td> </tr> <tr> <td>Hardware error occurs.</td> <td>■</td> <td>□</td> <td>□</td> <td>□</td> </tr> <tr> <td>Alert alarm 1 is turned on.</td> <td>□</td> <td>■</td> <td>■</td> <td>■</td> </tr> <tr> <td>Alert alarm 2 is turned on.</td> <td>■</td> <td>■</td> <td>□</td> <td>□</td> </tr> <tr> <td>Alert alarm 3 is turned on.</td> <td>□</td> <td>□</td> <td>□</td> <td>□</td> </tr> <tr> <td>Alert alarm 4 is turned on.</td> <td>□</td> <td>□</td> <td>□</td> <td>■</td> </tr> <tr> <td>The heater disconnection alarm is detected.</td> <td>■</td> <td>□</td> <td>□</td> <td>□</td> </tr> <tr> <td>The loop disconnection is detected.</td> <td>□</td> <td>■</td> <td>□</td> <td>□</td> </tr> <tr> <td>The current error when the output is off is detected.</td> <td>□</td> <td>□</td> <td>□</td> <td>□</td> </tr> </tbody> </table>		CH1	CH2	CH3	CH4	PV exceeds the specified temperature measurement range in the input range.	■	■	□	■	PV is below the specified temperature measurement range in the input range.	□	■	■	■	Hardware error occurs.	■	□	□	□	Alert alarm 1 is turned on.	□	■	■	■	Alert alarm 2 is turned on.	■	■	□	□	Alert alarm 3 is turned on.	□	□	□	□	Alert alarm 4 is turned on.	□	□	□	■	The heater disconnection alarm is detected.	■	□	□	□	The loop disconnection is detected.	□	■	□	□	The current error when the output is off is detected.	□	□	□	□	1)	5	0005	6	0006	7	0007	8	0008		
	CH1	CH2	CH3	CH4																																																														
PV exceeds the specified temperature measurement range in the input range.	■	■	□	■																																																														
PV is below the specified temperature measurement range in the input range.	□	■	■	■																																																														
Hardware error occurs.	■	□	□	□																																																														
Alert alarm 1 is turned on.	□	■	■	■																																																														
Alert alarm 2 is turned on.	■	■	□	□																																																														
Alert alarm 3 is turned on.	□	□	□	□																																																														
Alert alarm 4 is turned on.	□	□	□	■																																																														
The heater disconnection alarm is detected.	■	□	□	□																																																														
The loop disconnection is detected.	□	■	□	□																																																														
The current error when the output is off is detected.	□	□	□	□																																																														

Screen Image	No.	Buffer memory address							
		CH1		CH2		CH3		CH4	
		dec.	hex.	dec.	hex.	dec.	hex.	dec.	hex.
<p>A1S64TCTT/RT-S1 Operation Monitor Screen(CH1)</p> <p>1) Input range R Measurement unit °C Dec. point position 0</p> <p>2) Man.Val.0 (MV) [%]</p> <p>3) Pro.Val. Dec.P.P.=0 012345 Set Val.Dec.P.P.=0 012345</p> <p>4) Proportional s.(P) 0123.5% Integral time(I) 0123 sec Derivative time(D) 0123sec</p> <p>5) Error address 0123; Cause Default setting registration.</p> <p>6) Alert alarm No. 1 2 3 4</p> <p>7) Set.Val.Dec.P.P.=0 012345 012345 012345 012345</p> <p>8) (SV) Dec.P.P.=0 0123.5 0123.5 0123.5 0123.5</p> <p>9) Mode setting 01 01 01 01</p> <p>10) Heat.cur.pro.vl. Heat.val.com.set Output Upper 012.4 %</p> <p>11) Limiter Lower 012.4 %</p> <p>12) CT selection 0 1</p> <p>13) Expanded graph PV SV -100 0 400</p> <p>14) Normal Graph PV SV -2000 0 8000</p> <p>15) Alert occurrence flag</p> <p>16) 17)</p>	1)	32	0020	64	0040	96	0060	128	0080
	2)	32	0020	64	0040	96	0060	128	0080
	3)	1	0001	2	0002	3	0003	4	0004
	4)	9	0009	10	000A	11	000B	12	000C
	5)	34	0022	66	0042	98	0062	130	0082
	6)	13	000D	14	000E	15	000F	16	0010
	7)	35	0023	67	0043	99	0063	131	0083
	8)	36	0024	68	0044	100	0064	132	0084
	9)	37	0025	69	0045	101	0065	133	0085
	10)	—	—	—	—	—	—	—	—
	11)	0	0000	0	0000	0	0000	0	0000
	12)	0	0000	0	0000	0	0000	0	0000
	13)	38	0026	70	0046	102	0066	134	0086
		to	to	to	to	to	to	to	to
		41	0029	73	0049	105	0069	137	0089
	14)	160	00A0	160	00A0	160	00A0	160	00A0
		to	to	to	to	to	to	to	to
		163	00A3	163	00A3	163	00A3	163	00A3
	15)	57	0039	89	0059	121	0079	153	0099
16)	25	0019	26	001A	27	001B	28	001C	
17)	171	00AB	172	00AC	173	00AD	174	00AE	
18)	42	002A	74	004A	106	006A	138	008A	
	43	002B	75	004B	107	006B	139	008B	
19)	—	—	—	—	—	—	—	—	

12.28 Q64AD,Q68ADV,Q68ADI Module Monitor

Screen Image		No.	Buffer memory address	
			dec.	hex.
		1)	0	0000
		2)	10	000A
		3)	9	0009
		4)	9	0009
		5)	20, 21	0014, 0015
		6)	19	0013
		7)	1 to 8	0001 to 0008
		8)	11 to 18	000B to 0012
		9)	30, 32, 34, 36, 38, 40, 42, 44	001E, 0020, 0022, 0024, 0026, 0028, 002A, 002C
		10)	31, 33, 35, 37, 39, 41, 43, 45	001F, 0021, 0023, 0025, 0027, 0029, 002B, 002D
		1)	---	---
		1)	11 to 18	000B to 0012
		2)	---	---

12.29 Q62DA,Q64DA Module Monitor

Screen Image	No.	Buffer memory address																																			
		dec.	hex.																																		
<p>Q62DA/64DA Operation Monitor</p> <table border="1"> <thead> <tr> <th>Item</th> <th>Channels</th> <th>Error code</th> <th>Remarks</th> </tr> </thead> <tbody> <tr> <td>D/A conv</td> <td>0110</td> <td>012</td> <td>0:enable 1:disable</td> </tr> <tr> <td>Setting range</td> <td>0123 (HEX)</td> <td></td> <td>0:4 to 20(mA) 1:0to20(mA) 2:1 to 5(V) 3:0 to 5(V) 4:-10to+10(V) F:User range setting</td> </tr> </tbody> </table> <table border="1"> <thead> <tr> <th rowspan="2"></th> <th rowspan="2">Digital value</th> <th colspan="2">Set value</th> </tr> <tr> <th>Over</th> <th>Under</th> </tr> </thead> <tbody> <tr> <td>CH1</td> <td>01234</td> <td>█</td> <td>█</td> </tr> <tr> <td>CH2</td> <td>01234</td> <td>█</td> <td>█</td> </tr> <tr> <td>CH3</td> <td>01234</td> <td>█</td> <td>█</td> </tr> <tr> <td>CH4</td> <td>01234</td> <td>█</td> <td>█</td> </tr> </tbody> </table>	Item	Channels	Error code	Remarks	D/A conv	0110	012	0:enable 1:disable	Setting range	0123 (HEX)		0:4 to 20(mA) 1:0to20(mA) 2:1 to 5(V) 3:0 to 5(V) 4:-10to+10(V) F:User range setting		Digital value	Set value		Over	Under	CH1	01234	█	█	CH2	01234	█	█	CH3	01234	█	█	CH4	01234	█	█	1)	0	0000
	Item	Channels	Error code	Remarks																																	
	D/A conv	0110	012	0:enable 1:disable																																	
	Setting range	0123 (HEX)		0:4 to 20(mA) 1:0to20(mA) 2:1 to 5(V) 3:0 to 5(V) 4:-10to+10(V) F:User range setting																																	
		Digital value	Set value																																		
Over			Under																																		
CH1	01234	█	█																																		
CH2	01234	█	█																																		
CH3	01234	█	█																																		
CH4	01234	█	█																																		
	2)	20	0014																																		
	3)	1 to 4	0001 to 0004																																		
	4)	11 to 14	000B to 000E																																		
	5)	19	0013																																		
<p>Q62DA/Q64DA Input/Output Monitor</p> <table border="1"> <thead> <tr> <th>X</th> <th>Y</th> </tr> </thead> <tbody> <tr><td>00 Module_READY</td><td>00</td></tr> <tr><td>01 Op.cond.set done</td><td>01 1CH Output ON/OFF</td></tr> <tr><td>02 Offset/gain mode</td><td>02 2CH Output ON/OFF</td></tr> <tr><td>03 Ch. change done</td><td>03 3CH Output ON/OFF</td></tr> <tr><td>04 Set_val. change</td><td>04 4CH Output ON/OFF</td></tr> <tr><td>05 Sync.output mode</td><td>05</td></tr> <tr><td>06 Error flag</td><td>06</td></tr> <tr><td>07</td><td>07 Error clear req.</td></tr> </tbody> </table>	X	Y	00 Module_READY	00	01 Op.cond.set done	01 1CH Output ON/OFF	02 Offset/gain mode	02 2CH Output ON/OFF	03 Ch. change done	03 3CH Output ON/OFF	04 Set_val. change	04 4CH Output ON/OFF	05 Sync.output mode	05	06 Error flag	06	07	07 Error clear req.	1)	---	---																
	X	Y																																			
00 Module_READY	00																																				
01 Op.cond.set done	01 1CH Output ON/OFF																																				
02 Offset/gain mode	02 2CH Output ON/OFF																																				
03 Ch. change done	03 3CH Output ON/OFF																																				
04 Set_val. change	04 4CH Output ON/OFF																																				
05 Sync.output mode	05																																				
06 Error flag	06																																				
07	07 Error clear req.																																				
<p>Q62DA/Q64DA Graph Monitor</p> <p>CH1: CH2: CH3: CH4: Input</p> <p>Minimum error Maximum error</p> <table border="1"> <thead> <tr> <th></th> <th>Minimum error</th> <th>Maximum error</th> </tr> </thead> <tbody> <tr><td>CH1</td><td>█</td><td>█</td></tr> <tr><td>CH2</td><td>█</td><td>█</td></tr> <tr><td>CH3</td><td>█</td><td>█</td></tr> <tr><td>CH4</td><td>█</td><td>█</td></tr> </tbody> </table>		Minimum error	Maximum error	CH1	█	█	CH2	█	█	CH3	█	█	CH4	█	█	1)	11 to 14	000B to 000E																			
		Minimum error	Maximum error																																		
	CH1	█	█																																		
	CH2	█	█																																		
CH3	█	█																																			
CH4	█	█																																			
	2)	11 to 14	000B to 000E																																		
	3)	1 to 4	0001 to 0004																																		
	4)	---	---																																		

12.30 QD62,QD62D Module Monitor

Screen Image		No.	Buffer memory address	
			dec.	hex.
		1)	00 to 01	0000 to 0001
		2)	32 to 33	0020 to 0021
		2)	02 to 03	0002 to 0003
		2)	34 to 35	0022 to 0023
		3)	04 to 05	0004 to 0005
		3)	36 to 37	0024 to 0025
		4)	06 to 07	0006 to 0007
		4)	38 to 39	0026 to 0027
		5)	10, 42	000A, 002A
		6)	12 to 13	000C to 000D
		6)	44 to 45	002C to 002D
		7)	14 to 15	000E to 000F
		7)	46 to 47	002E to 002F
				8)
8)	48 to 49			0030 to 0031
9)	18 to 19			0012 to 0013
9)	50 to 51			0032 to 0033
10)	20 to 21			0014 to 0015
10)	52 to 53			0034 to 0035
11)	22 to 23			0016 to 0017
11)	54 to 55			0036 to 0037
12)	08, 40			0008, 0028
13)	11, 43			000B, 002B
14)	09, 41			0009, 0029
1)	---			---
1)	---			---

12.31 QD75P ,QD75D Module Monitor

Screen Image		No.	Buffer memory address	
			dec.	hex.
		1)	800 to 801	0320 to 0321
			900 to 901	0384 to 0385
			1000 to 1001	03E8 to 03E9
			1100 to 1101	044C to 044D
		2)	812 to 813	032C to 032D
			912 to 913	0390 to 0391
			1012 to 1013	03F4 to 03F5
			1112 to 1113	0458 to 0459
		3)	809, 909,	0329, 038D,
	1009, 1109	03F1, 0455		
4)	806, 906,	0326, 038A,		
	1006, 1106	03EE, 0452		
5)	807, 907,	0327, 038B,		
	1007, 1107	03EF, 0453		
6)	808, 908,	0328, 038C,		
	1008, 1108	03F0, 0454		
7)	829, 929,	033D, 03A1,		
	1029, 1129	0405, 0469		
8)	838, 938,	0346, 03AA,		
9)	1038, 1138	040E, 0472		
		1)	---	---
		1)	0, 150, 300, 450	0000, 0096, 012C, 01C2
		2)	4, 154, 304, 454	0004, 009A, 0130, 01C6
		3)	1, 151, 301, 451	0001, 0097, 012D, 01C3
		4)	2, 152, 302, 452	0002, 0098, 012E, 01C4
		5)	3, 153, 303, 453	0003, 0099, 012F, 01C5
		6)	5, 155, 305, 455	0005, 009B, 0131, 01C7
		7)	6, 156, 306, 456	0006, 009C, 0132, 01C8



Screen Image		No.	Buffer memory address																																																																																															
			dec.	hex.																																																																																														
<p>QD75P/QD75D Basic parameters 2</p> <table border="1"> <tr> <th colspan="4">Speed limit value</th> <th colspan="4">Deceleration time 0</th> </tr> <tr> <td>Axis1</td><td>0123456789</td> <td>Axis2</td><td>0123456789</td> <td>Axis1</td><td>01234567</td> <td>Axis2</td><td>01234567</td> </tr> <tr> <td>Axis3</td><td>0123456789</td> <td>Axis4</td><td>0123456789</td> <td>Axis3</td><td>01234567</td> <td>Axis4</td><td>01234567</td> </tr> <tr> <td>Setting range</td><td colspan="3">1 to 2000000000 (mm/min):*10⁻² (inch/min):*10⁻⁴ (degree/min):*10⁻⁴</td> <td>Setting range</td><td colspan="3">1 to 8388608(msec)</td> </tr> </table> <table border="1"> <tr> <th colspan="4">Acceleration time 0</th> </tr> <tr> <td>Axis1</td><td>01234567</td> <td>Axis2</td><td>01234567</td> </tr> <tr> <td>Axis3</td><td>01234567</td> <td>Axis4</td><td>01234567</td> </tr> <tr> <td>Setting range</td><td colspan="3">1 to 8388608(msec)</td> </tr> </table>	Speed limit value				Deceleration time 0				Axis1	0123456789	Axis2	0123456789	Axis1	01234567	Axis2	01234567	Axis3	0123456789	Axis4	0123456789	Axis3	01234567	Axis4	01234567	Setting range	1 to 2000000000 (mm/min):*10 ⁻² (inch/min):*10 ⁻⁴ (degree/min):*10 ⁻⁴			Setting range	1 to 8388608(msec)			Acceleration time 0				Axis1	01234567	Axis2	01234567	Axis3	01234567	Axis4	01234567	Setting range	1 to 8388608(msec)			1)	10 to 11	000A to 000B																																															
	Speed limit value				Deceleration time 0																																																																																													
	Axis1	0123456789	Axis2	0123456789	Axis1	01234567	Axis2	01234567																																																																																										
	Axis3	0123456789	Axis4	0123456789	Axis3	01234567	Axis4	01234567																																																																																										
	Setting range	1 to 2000000000 (mm/min):*10 ⁻² (inch/min):*10 ⁻⁴ (degree/min):*10 ⁻⁴			Setting range	1 to 8388608(msec)																																																																																												
	Acceleration time 0																																																																																																	
	Axis1	01234567	Axis2	01234567																																																																																														
	Axis3	01234567	Axis4	01234567																																																																																														
	Setting range	1 to 8388608(msec)																																																																																																
	<p>QD75P/QD75D Detailed parameters 1-1</p> <table border="1"> <tr> <th colspan="4">Backlash compensation amount</th> <th colspan="4">Manual pulse generator input selection</th> </tr> <tr> <td>Axis1</td><td>01234</td> <td>Axis2</td><td>01234</td> <td>Axis1</td><td>0</td> <td>Axis2</td><td>-</td> </tr> <tr> <td>Axis3</td><td>01234</td> <td>Axis4</td><td>01234</td> <td>Axis3</td><td>-</td> <td>Axis4</td><td>-</td> </tr> <tr> <td>Setting range</td><td colspan="3">0 to 65535 (μm):*10⁻¹ (inch):*10⁻⁴ (degree):*10⁻⁴ (pulse):*1</td> <td>Setting range</td><td colspan="3">0: A-phase/B-phase; multiplied by 4 1: A-phase/B-phase; multiplied by 2 2: A-phase/B-phase; multiplied by 1 3: PLS/SIGN</td> </tr> </table> <table border="1"> <tr> <th colspan="4">Software stroke order limit value</th> <th colspan="4">S/W stroke limit select</th> </tr> <tr> <td>High Lmt</td><td>Axis 1</td><td>01234567890</td> <td>Axis 2</td><td>01234567890</td> <td>0</td><td>0</td><td>0</td><td>0</td> </tr> <tr> <td>Low Lmt</td><td>Axis 3</td><td>01234567890</td> <td>Axis 4</td><td>01234567890</td> <td>0</td><td>0</td><td>0</td><td>0</td> </tr> <tr> <td>Setting range</td><td colspan="3">-2147483648 (μm):*10¹(inch):*10⁻⁵ to 2147483647 (pulse):*1 (degree):*10⁴</td> <td>S/W stroke limit OK/NG setting</td><td colspan="3">0: valid 1: invalid</td> <td>Torque limit set value</td><td>012 012 012 012 1~500 [%]</td> </tr> </table>	Backlash compensation amount				Manual pulse generator input selection				Axis1	01234	Axis2	01234	Axis1	0	Axis2	-	Axis3	01234	Axis4	01234	Axis3	-	Axis4	-	Setting range	0 to 65535 (μm):*10 ⁻¹ (inch):*10 ⁻⁴ (degree):*10 ⁻⁴ (pulse):*1			Setting range	0: A-phase/B-phase; multiplied by 4 1: A-phase/B-phase; multiplied by 2 2: A-phase/B-phase; multiplied by 1 3: PLS/SIGN			Software stroke order limit value				S/W stroke limit select				High Lmt	Axis 1	01234567890	Axis 2	01234567890	0	0	0	0	Low Lmt	Axis 3	01234567890	Axis 4	01234567890	0	0	0	0	Setting range	-2147483648 (μm):*10 ¹ (inch):*10 ⁻⁵ to 2147483647 (pulse):*1 (degree):*10 ⁴			S/W stroke limit OK/NG setting	0: valid 1: invalid			Torque limit set value	012 012 012 012 1~500 [%]	2)	17, 167, 317, 467	0011, 00A7, 013D, 01D3																										
		Backlash compensation amount				Manual pulse generator input selection																																																																																												
		Axis1	01234	Axis2	01234	Axis1	0	Axis2	-																																																																																									
Axis3		01234	Axis4	01234	Axis3	-	Axis4	-																																																																																										
Setting range		0 to 65535 (μm):*10 ⁻¹ (inch):*10 ⁻⁴ (degree):*10 ⁻⁴ (pulse):*1			Setting range	0: A-phase/B-phase; multiplied by 4 1: A-phase/B-phase; multiplied by 2 2: A-phase/B-phase; multiplied by 1 3: PLS/SIGN																																																																																												
Software stroke order limit value				S/W stroke limit select																																																																																														
High Lmt		Axis 1	01234567890	Axis 2	01234567890	0	0	0	0																																																																																									
Low Lmt		Axis 3	01234567890	Axis 4	01234567890	0	0	0	0																																																																																									
Setting range		-2147483648 (μm):*10 ¹ (inch):*10 ⁻⁵ to 2147483647 (pulse):*1 (degree):*10 ⁴			S/W stroke limit OK/NG setting	0: valid 1: invalid			Torque limit set value	012 012 012 012 1~500 [%]																																																																																								
<p>QD75P/QD75D Detailed parameters 1-2</p> <table border="1"> <tr> <th colspan="4">Item</th> <th colspan="4">Current feed val. during speed control</th> </tr> <tr> <td>Mcode ON sig O/P timing</td> <td>0</td><td>0</td><td>0</td><td>0</td> <td>Axis 1</td><td>0</td> <td>Axis 2</td><td>0</td> </tr> <tr> <td>Speed switching mode</td> <td>0</td><td>0</td><td>0</td><td>0</td> <td>Axis 3</td><td>0</td> <td>Axis 4</td><td>0</td> </tr> <tr> <td>Interpolate speed set method</td> <td>0</td><td>0</td><td>0</td><td>0</td> <td>0: Do Not/1: Do/2: Clear(0)</td> <td colspan="3"></td> </tr> <tr> <td>Command in-position width</td> <td>Axis1</td><td>01234567890</td> <td>Axis2</td><td>01234567890</td> <th colspan="4">Output signal logic selection</th> </tr> <tr> <td>Axis3</td><td>01234567890</td> <td>Axis4</td><td>01234567890</td> <td>Comm. pulse signal</td><td>Ne</td><td>Ne</td><td>Ne</td><td>Ne</td> </tr> <tr> <td>Setting range</td><td colspan="3">1 to 2147483647 (μm):*10⁻¹(inch):*10⁻⁴ (degree):*10⁻⁴(pulse):*1</td> <td>Dev. counter clear</td><td>Ne</td><td>Ne</td><td>Ne</td><td>Ne</td> </tr> </table> <table border="1"> <tr> <th colspan="4">Item</th> </tr> <tr> <td>Lower limit</td><td>Ne</td><td>Ne</td><td>Ne</td> </tr> <tr> <td>Upper limit</td><td>Ne</td><td>Ne</td><td>Ne</td> </tr> <tr> <td>Drive unit READY</td><td>Ne</td><td>Ne</td><td>Ne</td> </tr> <tr> <td>Stop signal</td><td>Ne</td><td>Ne</td><td>Ne</td> </tr> <tr> <td>External command</td><td>Ne</td><td>Ne</td><td>Ne</td> </tr> <tr> <td>Zero signal</td><td>Ne</td><td>Ne</td><td>Ne</td> </tr> <tr> <td>Near point dog</td><td>Ne</td><td>Ne</td><td>Ne</td> </tr> </table>		Item				Current feed val. during speed control				Mcode ON sig O/P timing	0	0	0	0	Axis 1	0	Axis 2	0	Speed switching mode	0	0	0	0	Axis 3	0	Axis 4	0	Interpolate speed set method	0	0	0	0	0: Do Not/1: Do/2: Clear(0)				Command in-position width	Axis1	01234567890	Axis2	01234567890	Output signal logic selection				Axis3	01234567890	Axis4	01234567890	Comm. pulse signal	Ne	Ne	Ne	Ne	Setting range	1 to 2147483647 (μm):*10 ⁻¹ (inch):*10 ⁻⁴ (degree):*10 ⁻⁴ (pulse):*1			Dev. counter clear	Ne	Ne	Ne	Ne	Item				Lower limit	Ne	Ne	Ne	Upper limit	Ne	Ne	Ne	Drive unit READY	Ne	Ne	Ne	Stop signal	Ne	Ne	Ne	External command	Ne	Ne	Ne	Zero signal	Ne	Ne	Ne	Near point dog	Ne	Ne	Ne	3)	18 to 19	0012 to 0013
		Item				Current feed val. during speed control																																																																																												
	Mcode ON sig O/P timing	0	0	0	0	Axis 1	0	Axis 2	0																																																																																									
	Speed switching mode	0	0	0	0	Axis 3	0	Axis 4	0																																																																																									
	Interpolate speed set method	0	0	0	0	0: Do Not/1: Do/2: Clear(0)																																																																																												
	Command in-position width	Axis1	01234567890	Axis2	01234567890	Output signal logic selection																																																																																												
	Axis3	01234567890	Axis4	01234567890	Comm. pulse signal	Ne	Ne	Ne	Ne																																																																																									
	Setting range	1 to 2147483647 (μm):*10 ⁻¹ (inch):*10 ⁻⁴ (degree):*10 ⁻⁴ (pulse):*1			Dev. counter clear	Ne	Ne	Ne	Ne																																																																																									
	Item																																																																																																	
	Lower limit	Ne	Ne	Ne																																																																																														
	Upper limit	Ne	Ne	Ne																																																																																														
Drive unit READY	Ne	Ne	Ne																																																																																															
Stop signal	Ne	Ne	Ne																																																																																															
External command	Ne	Ne	Ne																																																																																															
Zero signal	Ne	Ne	Ne																																																																																															
Near point dog	Ne	Ne	Ne																																																																																															
<p>QD75P/QD75D Detailed parameters 1-2</p> <table border="1"> <tr> <th colspan="4">Item</th> <th colspan="4">S/W stroke limit select</th> </tr> <tr> <td>High Lmt</td><td>Axis 1</td><td>01234567890</td> <td>Axis 2</td><td>01234567890</td> <td>0</td><td>0</td><td>0</td><td>0</td> </tr> <tr> <td>Low Lmt</td><td>Axis 3</td><td>01234567890</td> <td>Axis 4</td><td>01234567890</td> <td>0</td><td>0</td><td>0</td><td>0</td> </tr> <tr> <td>Setting range</td><td colspan="3">-2147483648 (μm):*10¹(inch):*10⁻⁵ to 2147483647 (pulse):*1 (degree):*10⁴</td> <td>S/W stroke limit OK/NG setting</td><td colspan="3">0: valid 1: invalid</td> <td>Torque limit set value</td><td>012 012 012 012 1~500 [%]</td> </tr> </table>	Item				S/W stroke limit select				High Lmt	Axis 1	01234567890	Axis 2	01234567890	0	0	0	0	Low Lmt	Axis 3	01234567890	Axis 4	01234567890	0	0	0	0	Setting range	-2147483648 (μm):*10 ¹ (inch):*10 ⁻⁵ to 2147483647 (pulse):*1 (degree):*10 ⁴			S/W stroke limit OK/NG setting	0: valid 1: invalid			Torque limit set value	012 012 012 012 1~500 [%]	4)	170 to 171	00AA to 00AB																																																											
	Item				S/W stroke limit select																																																																																													
	High Lmt	Axis 1	01234567890	Axis 2	01234567890	0	0	0	0																																																																																									
	Low Lmt	Axis 3	01234567890	Axis 4	01234567890	0	0	0	0																																																																																									
	Setting range	-2147483648 (μm):*10 ¹ (inch):*10 ⁻⁵ to 2147483647 (pulse):*1 (degree):*10 ⁴			S/W stroke limit OK/NG setting	0: valid 1: invalid			Torque limit set value	012 012 012 012 1~500 [%]																																																																																								
	<p>QD75P/QD75D Detailed parameters 1-2</p> <table border="1"> <tr> <th colspan="4">Item</th> <th colspan="4">S/W stroke limit select</th> </tr> <tr> <td>High Lmt</td><td>Axis 1</td><td>01234567890</td> <td>Axis 2</td><td>01234567890</td> <td>0</td><td>0</td><td>0</td><td>0</td> </tr> <tr> <td>Low Lmt</td><td>Axis 3</td><td>01234567890</td> <td>Axis 4</td><td>01234567890</td> <td>0</td><td>0</td><td>0</td><td>0</td> </tr> <tr> <td>Setting range</td><td colspan="3">-2147483648 (μm):*10¹(inch):*10⁻⁵ to 2147483647 (pulse):*1 (degree):*10⁴</td> <td>S/W stroke limit OK/NG setting</td><td colspan="3">0: valid 1: invalid</td> <td>Torque limit set value</td><td>012 012 012 012 1~500 [%]</td> </tr> </table>	Item				S/W stroke limit select				High Lmt	Axis 1	01234567890	Axis 2	01234567890	0	0	0	0	Low Lmt	Axis 3	01234567890	Axis 4	01234567890	0	0	0	0	Setting range	-2147483648 (μm):*10 ¹ (inch):*10 ⁻⁵ to 2147483647 (pulse):*1 (degree):*10 ⁴			S/W stroke limit OK/NG setting	0: valid 1: invalid			Torque limit set value	012 012 012 012 1~500 [%]	5)	320 to 321	0140 to 0141																																																										
		Item				S/W stroke limit select																																																																																												
		High Lmt	Axis 1	01234567890	Axis 2	01234567890	0	0	0	0																																																																																								
		Low Lmt	Axis 3	01234567890	Axis 4	01234567890	0	0	0	0																																																																																								
		Setting range	-2147483648 (μm):*10 ¹ (inch):*10 ⁻⁵ to 2147483647 (pulse):*1 (degree):*10 ⁴			S/W stroke limit OK/NG setting	0: valid 1: invalid			Torque limit set value	012 012 012 012 1~500 [%]																																																																																							
		<p>QD75P/QD75D Detailed parameters 1-2</p> <table border="1"> <tr> <th colspan="4">Item</th> <th colspan="4">S/W stroke limit select</th> </tr> <tr> <td>High Lmt</td><td>Axis 1</td><td>01234567890</td> <td>Axis 2</td><td>01234567890</td> <td>0</td><td>0</td><td>0</td><td>0</td> </tr> <tr> <td>Low Lmt</td><td>Axis 3</td><td>01234567890</td> <td>Axis 4</td><td>01234567890</td> <td>0</td><td>0</td><td>0</td><td>0</td> </tr> <tr> <td>Setting range</td><td colspan="3">-2147483648 (μm):*10¹(inch):*10⁻⁵ to 2147483647 (pulse):*1 (degree):*10⁴</td> <td>S/W stroke limit OK/NG setting</td><td colspan="3">0: valid 1: invalid</td> <td>Torque limit set value</td><td>012 012 012 012 1~500 [%]</td> </tr> </table>	Item				S/W stroke limit select				High Lmt	Axis 1	01234567890	Axis 2	01234567890	0	0	0	0	Low Lmt	Axis 3	01234567890	Axis 4	01234567890	0	0	0	0	Setting range	-2147483648 (μm):*10 ¹ (inch):*10 ⁻⁵ to 2147483647 (pulse):*1 (degree):*10 ⁴			S/W stroke limit OK/NG setting	0: valid 1: invalid			Torque limit set value	012 012 012 012 1~500 [%]	6)	470 to 471	01D6 to 01D7																																																									
Item				S/W stroke limit select																																																																																														
High Lmt			Axis 1	01234567890	Axis 2	01234567890	0	0	0	0																																																																																								
Low Lmt			Axis 3	01234567890	Axis 4	01234567890	0	0	0	0																																																																																								
Setting range			-2147483648 (μm):*10 ¹ (inch):*10 ⁻⁵ to 2147483647 (pulse):*1 (degree):*10 ⁴			S/W stroke limit OK/NG setting	0: valid 1: invalid			Torque limit set value	012 012 012 012 1~500 [%]																																																																																							
<p>QD75P/QD75D Detailed parameters 1-2</p> <table border="1"> <tr> <th colspan="4">Item</th> <th colspan="4">S/W stroke limit select</th> </tr> <tr> <td>High Lmt</td><td>Axis 1</td><td>01234567890</td> <td>Axis 2</td><td>01234567890</td> <td>0</td><td>0</td><td>0</td><td>0</td> </tr> <tr> <td>Low Lmt</td><td>Axis 3</td><td>01234567890</td> <td>Axis 4</td><td>01234567890</td> <td>0</td><td>0</td><td>0</td><td>0</td> </tr> <tr> <td>Setting range</td><td colspan="3">-2147483648 (μm):*10¹(inch):*10⁻⁵ to 2147483647 (pulse):*1 (degree):*10⁴</td> <td>S/W stroke limit OK/NG setting</td><td colspan="3">0: valid 1: invalid</td> <td>Torque limit set value</td><td>012 012 012 012 1~500 [%]</td> </tr> </table>			Item				S/W stroke limit select				High Lmt	Axis 1	01234567890	Axis 2	01234567890	0	0	0	0	Low Lmt	Axis 3	01234567890	Axis 4	01234567890	0	0	0	0	Setting range	-2147483648 (μm):*10 ¹ (inch):*10 ⁻⁵ to 2147483647 (pulse):*1 (degree):*10 ⁴			S/W stroke limit OK/NG setting	0: valid 1: invalid			Torque limit set value	012 012 012 012 1~500 [%]	7)	33, 183, 333, 483	0021, 00B7, 014D, 01E3																																																									
	Item				S/W stroke limit select																																																																																													
	High Lmt		Axis 1	01234567890	Axis 2	01234567890	0	0	0	0																																																																																								
	Low Lmt		Axis 3	01234567890	Axis 4	01234567890	0	0	0	0																																																																																								
	Setting range		-2147483648 (μm):*10 ¹ (inch):*10 ⁻⁵ to 2147483647 (pulse):*1 (degree):*10 ⁴			S/W stroke limit OK/NG setting	0: valid 1: invalid			Torque limit set value	012 012 012 012 1~500 [%]																																																																																							
	<p>QD75P/QD75D Detailed parameters 1-2</p> <table border="1"> <tr> <th colspan="4">Item</th> <th colspan="4">S/W stroke limit select</th> </tr> <tr> <td>High Lmt</td><td>Axis 1</td><td>01234567890</td> <td>Axis 2</td><td>01234567890</td> <td>0</td><td>0</td><td>0</td><td>0</td> </tr> <tr> <td>Low Lmt</td><td>Axis 3</td><td>01234567890</td> <td>Axis 4</td><td>01234567890</td> <td>0</td><td>0</td><td>0</td><td>0</td> </tr> <tr> <td>Setting range</td><td colspan="3">-2147483648 (μm):*10¹(inch):*10⁻⁵ to 2147483647 (pulse):*1 (degree):*10⁴</td> <td>S/W stroke limit OK/NG setting</td><td colspan="3">0: valid 1: invalid</td> <td>Torque limit set value</td><td>012 012 012 012 1~500 [%]</td> </tr> </table>		Item				S/W stroke limit select				High Lmt	Axis 1	01234567890	Axis 2	01234567890	0	0	0	0	Low Lmt	Axis 3	01234567890	Axis 4	01234567890	0	0	0	0	Setting range	-2147483648 (μm):*10 ¹ (inch):*10 ⁻⁵ to 2147483647 (pulse):*1 (degree):*10 ⁴			S/W stroke limit OK/NG setting	0: valid 1: invalid			Torque limit set value	012 012 012 012 1~500 [%]	8)	22, 172, 322, 472	0016, 00AC, 0142, 01D8																																																									
		Item				S/W stroke limit select																																																																																												
		High Lmt	Axis 1	01234567890	Axis 2	01234567890	0	0	0	0																																																																																								
		Low Lmt	Axis 3	01234567890	Axis 4	01234567890	0	0	0	0																																																																																								
		Setting range	-2147483648 (μm):*10 ¹ (inch):*10 ⁻⁵ to 2147483647 (pulse):*1 (degree):*10 ⁴			S/W stroke limit OK/NG setting	0: valid 1: invalid			Torque limit set value	012 012 012 012 1~500 [%]																																																																																							
		<p>QD75P/QD75D Detailed parameters 1-2</p> <table border="1"> <tr> <th colspan="4">Item</th> <th colspan="4">S/W stroke limit select</th> </tr> <tr> <td>High Lmt</td><td>Axis 1</td><td>01234567890</td> <td>Axis 2</td><td>01234567890</td> <td>0</td><td>0</td><td>0</td><td>0</td> </tr> <tr> <td>Low Lmt</td><td>Axis 3</td><td>01234567890</td> <td>Axis 4</td><td>01234567890</td> <td>0</td><td>0</td><td>0</td><td>0</td> </tr> <tr> <td>Setting range</td><td colspan="3">-2147483648 (μm):*10¹(inch):*10⁻⁵ to 2147483647 (pulse):*1 (degree):*10⁴</td> <td>S/W stroke limit OK/NG setting</td><td colspan="3">0: valid 1: invalid</td> <td>Torque limit set value</td><td>012 012 012 012 1~500 [%]</td> </tr> </table>	Item				S/W stroke limit select				High Lmt	Axis 1	01234567890	Axis 2	01234567890	0	0	0	0	Low Lmt	Axis 3	01234567890	Axis 4	01234567890	0	0	0	0	Setting range	-2147483648 (μm):*10 ¹ (inch):*10 ⁻⁵ to 2147483647 (pulse):*1 (degree):*10 ⁴			S/W stroke limit OK/NG setting	0: valid 1: invalid			Torque limit set value	012 012 012 012 1~500 [%]	9)	23, 173, 323, 473	0017, 00AD, 0143, 01D9																																																									
Item				S/W stroke limit select																																																																																														
High Lmt			Axis 1	01234567890	Axis 2	01234567890	0	0	0	0																																																																																								
Low Lmt			Axis 3	01234567890	Axis 4	01234567890	0	0	0	0																																																																																								
Setting range			-2147483648 (μm):*10 ¹ (inch):*10 ⁻⁵ to 2147483647 (pulse):*1 (degree):*10 ⁴			S/W stroke limit OK/NG setting	0: valid 1: invalid			Torque limit set value	012 012 012 012 1~500 [%]																																																																																							
<p>QD75P/QD75D Detailed parameters 1-2</p> <table border="1"> <tr> <th colspan="4">Item</th> <th colspan="4">S/W stroke limit select</th> </tr> <tr> <td>High Lmt</td><td>Axis 1</td><td>01234567890</td> <td>Axis 2</td><td>01234567890</td> <td>0</td><td>0</td><td>0</td><td>0</td> </tr> <tr> <td>Low Lmt</td><td>Axis 3</td><td>01234567890</td> <td>Axis 4</td><td>01234567890</td> <td>0</td><td>0</td><td>0</td><td>0</td> </tr> <tr> <td>Setting range</td><td colspan="3">-2147483648 (μm):*10¹(inch):*10⁻⁵ to 2147483647 (pulse):*1 (degree):*10⁴</td> <td>S/W stroke limit OK/NG setting</td><td colspan="3">0: valid 1: invalid</td> <td>Torque limit set value</td><td>012 012 012 012 1~500 [%]</td> </tr> </table>			Item				S/W stroke limit select				High Lmt	Axis 1	01234567890	Axis 2	01234567890	0	0	0	0	Low Lmt	Axis 3	01234567890	Axis 4	01234567890	0	0	0	0	Setting range	-2147483648 (μm):*10 ¹ (inch):*10 ⁻⁵ to 2147483647 (pulse):*1 (degree):*10 ⁴			S/W stroke limit OK/NG setting	0: valid 1: invalid			Torque limit set value	012 012 012 012 1~500 [%]	10)	26, 176, 326, 476	001A, 00B0, 0146, 01DC																																																									
	Item				S/W stroke limit select																																																																																													
	High Lmt		Axis 1	01234567890	Axis 2	01234567890	0	0	0	0																																																																																								
	Low Lmt		Axis 3	01234567890	Axis 4	01234567890	0	0	0	0																																																																																								
	Setting range		-2147483648 (μm):*10 ¹ (inch):*10 ⁻⁵ to 2147483647 (pulse):*1 (degree):*10 ⁴			S/W stroke limit OK/NG setting	0: valid 1: invalid			Torque limit set value	012 012 012 012 1~500 [%]																																																																																							
	<p>QD75P/QD75D Detailed parameters 1-2</p> <table border="1"> <tr> <th colspan="4">Item</th> <th colspan="4">S/W stroke limit select</th> </tr> <tr> <td>High Lmt</td><td>Axis 1</td><td>01234567890</td> <td>Axis 2</td><td>01234567890</td> <td>0</td><td>0</td><td>0</td><td>0</td> </tr> <tr> <td>Low Lmt</td><td>Axis 3</td><td>01234567890</td> <td>Axis 4</td><td>01234567890</td> <td>0</td><td>0</td><td>0</td><td>0</td> </tr> <tr> <td>Setting range</td><td colspan="3">-2147483648 (μm):*10¹(inch):*10⁻⁵ to 2147483647 (pulse):*1 (degree):*10⁴</td> <td>S/W stroke limit OK/NG setting</td><td colspan="3">0: valid 1: invalid</td> <td>Torque limit set value</td><td>012 012 012 012 1~500 [%]</td> </tr> </table>		Item				S/W stroke limit select				High Lmt	Axis 1	01234567890	Axis 2	01234567890	0	0	0	0	Low Lmt	Axis 3	01234567890	Axis 4	01234567890	0	0	0	0	Setting range	-2147483648 (μm):*10 ¹ (inch):*10 ⁻⁵ to 2147483647 (pulse):*1 (degree):*10 ⁴			S/W stroke limit OK/NG setting	0: valid 1: invalid			Torque limit set value	012 012 012 012 1~500 [%]	11)	27, 177, 327, 477	001B, 00B1, 0147, 01DD																																																									
		Item				S/W stroke limit select																																																																																												
		High Lmt	Axis 1	01234567890	Axis 2	01234567890	0	0	0	0																																																																																								
		Low Lmt	Axis 3	01234567890	Axis 4	01234567890	0	0	0	0																																																																																								
		Setting range	-2147483648 (μm):*10 ¹ (inch):*10 ⁻⁵ to 2147483647 (pulse):*1 (degree):*10 ⁴			S/W stroke limit OK/NG setting	0: valid 1: invalid			Torque limit set value	012 012 012 012 1~500 [%]																																																																																							
		<p>QD75P/QD75D Detailed parameters 1-2</p> <table border="1"> <tr> <th colspan="4">Item</th> <th colspan="4">S/W stroke limit select</th> </tr> <tr> <td>High Lmt</td><td>Axis 1</td><td>01234567890</td> <td>Axis 2</td><td>01234567890</td> <td>0</td><td>0</td><td>0</td><td>0</td> </tr> <tr> <td>Low Lmt</td><td>Axis 3</td><td>01234567890</td> <td>Axis 4</td><td>01234567890</td> <td>0</td><td>0</td><td>0</td><td>0</td> </tr> <tr> <td>Setting range</td><td colspan="3">-2147483648 (μm):*10¹(inch):*10⁻⁵ to 2147483647 (pulse):*1 (degree):*10⁴</td> <td>S/W stroke limit OK/NG setting</td><td colspan="3">0: valid 1: invalid</td> <td>Torque limit set value</td><td>012 012 012 012 1~500 [%]</td> </tr> </table>	Item				S/W stroke limit select				High Lmt	Axis 1	01234567890	Axis 2	01234567890	0	0	0	0	Low Lmt	Axis 3	01234567890	Axis 4	01234567890	0	0	0	0	Setting range	-2147483648 (μm):*10 ¹ (inch):*10 ⁻⁵ to 2147483647 (pulse):*1 (degree):*10 ⁴			S/W stroke limit OK/NG setting	0: valid 1: invalid			Torque limit set value	012 012 012 012 1~500 [%]	12)	28, 178, 328, 478	001C, 00B2, 0148, 01DE																																																									
Item				S/W stroke limit select																																																																																														
High Lmt			Axis 1	01234567890	Axis 2	01234567890	0	0	0	0																																																																																								
Low Lmt			Axis 3	01234567890	Axis 4	01234567890	0	0	0	0																																																																																								
Setting range			-2147483648 (μm):*10 ¹ (inch):*10 ⁻⁵ to 2147483647 (pulse):*1 (degree):*10 ⁴			S/W stroke limit OK/NG setting	0: valid 1: invalid			Torque limit set value	012 012 012 012 1~500 [%]																																																																																							
<p>QD75P/QD75D Detailed parameters 1-2</p> <table border="1"> <tr> <th colspan="4">Item</th> <th colspan="4">S/W stroke limit select</th> </tr> <tr> <td>High Lmt</td><td>Axis 1</td><td>01234567890</td> <td>Axis 2</td><td>01234567890</td> <td>0</td><td>0</td><td>0</td><td>0</td> </tr> <tr> <td>Low Lmt</td><td>Axis 3</td><td>01234567890</td> <td>Axis 4</td><td>01234567890</td> <td>0</td><td>0</td><td>0</td><td>0</td> </tr> <tr> <td>Setting range</td><td colspan="3">-2147483648 (μm):*10¹(inch):*10⁻⁵ to 2147483647 (pulse):*1 (degree):*10⁴</td> <td>S/W stroke limit OK/NG setting</td><td colspan="3">0: valid 1: invalid</td> <td>Torque limit set value</td><td>012 012 012 012 1~500 [%]</td> </tr> </table>			Item				S/W stroke limit select				High Lmt	Axis 1	01234567890	Axis 2	01234567890	0	0	0	0	Low Lmt	Axis 3	01234567890	Axis 4	01234567890	0	0	0	0	Setting range	-2147483648 (μm):*10 ¹ (inch):*10 ⁻⁵ to 2147483647 (pulse):*1 (degree):*10 ⁴			S/W stroke limit OK/NG setting	0: valid 1: invalid			Torque limit set value	012 012 012 012 1~500 [%]	13)	29, 179, 329, 479	001D, 00B3, 0149, 01DF																																																									
	Item				S/W stroke limit select																																																																																													
	High Lmt		Axis 1	01234567890	Axis 2	01234567890	0	0	0	0																																																																																								
	Low Lmt		Axis 3	01234567890	Axis 4	01234567890	0	0	0	0																																																																																								
	Setting range		-2147483648 (μm):*10 ¹ (inch):*10 ⁻⁵ to 2147483647 (pulse):*1 (degree):*10 ⁴			S/W stroke limit OK/NG setting	0: valid 1: invalid			Torque limit set value	012 012 012 012 1~500 [%]																																																																																							
	<p>QD75P/QD75D Detailed parameters 1-2</p> <table border="1"> <tr> <th colspan="4">Item</th> <th colspan="4">S/W stroke limit select</th> </tr> <tr> <td>High Lmt</td><td>Axis 1</td><td>01234567890</td> <td>Axis 2</td><td>01234567890</td> <td>0</td><td>0</td><td>0</td><td>0</td> </tr> <tr> <td>Low Lmt</td><td>Axis 3</td><td>01234567890</td> <td>Axis 4</td><td>01234567890</td> <td>0</td><td>0</td><td>0</td><td>0</td> </tr> <tr> <td>Setting range</td><td colspan="3">-2147483648 (μm):*10¹(inch):*10⁻⁵ to 2147483647 (pulse):*1 (degree):*10⁴</td> <td>S/W stroke limit OK/NG setting</td><td colspan="3">0: valid 1: invalid</td> <td>Torque limit set value</td><td>012 012 012 012 1~500 [%]</td> </tr> </table>		Item				S/W stroke limit select				High Lmt	Axis 1	01234567890	Axis 2	01234567890	0	0	0	0	Low Lmt	Axis 3	01234567890	Axis 4	01234567890	0	0	0	0	Setting range	-2147483648 (μm):*10 ¹ (inch):*10 ⁻⁵ to 2147483647 (pulse):*1 (degree):*10 ⁴			S/W stroke limit OK/NG setting	0: valid 1: invalid			Torque limit set value	012 012 012 012 1~500 [%]	14)	24 to 25	0018 to 0019																																																									
		Item				S/W stroke limit select																																																																																												
		High Lmt	Axis 1	01234567890	Axis 2	01234567890	0	0	0	0																																																																																								
		Low Lmt	Axis 3	01234567890	Axis 4	01234567890	0	0	0	0																																																																																								
		Setting range	-2147483648 (μm):*10 ¹ (inch):*10 ⁻⁵ to 2147483647 (pulse):*1 (degree):*10 ⁴			S/W stroke limit OK/NG setting	0: valid 1: invalid			Torque limit set value	012 012 012 012 1~500 [%]																																																																																							
		<p>QD75P/QD75D Detailed parameters 1-2</p> <table border="1"> <tr> <th colspan="4">Item</th> <th colspan="4">S/W stroke limit select</th> </tr> <tr> <td>High Lmt</td><td>Axis 1</td><td>01234567890</td> <td>Axis 2</td><td>01234567890</td> <td>0</td><td>0</td><td>0</td><td>0</td> </tr> <tr> <td>Low Lmt</td><td>Axis 3</td><td>01234567890</td> <td>Axis 4</td><td>01234567890</td> <td>0</td><td>0</td><td>0</td><td>0</td> </tr> <tr> <td>Setting range</td><td colspan="3">-2147483648 (μm):*10¹(inch):*10⁻⁵ to 2147483647 (pulse):*1 (degree):*10⁴</td> <td>S/W stroke limit OK/NG setting</td><td colspan="3">0: valid 1: invalid</td> <td>Torque limit set value</td><td>012 012 012 012 1~500 [%]</td> </tr> </table>	Item				S/W stroke limit select				High Lmt	Axis 1	01234567890	Axis 2	01234567890	0	0	0	0	Low Lmt	Axis 3	01234567890	Axis 4	01234567890	0	0	0	0	Setting range	-2147483648 (μm):*10 ¹ (inch):*10 ⁻⁵ to 2147483647 (pulse):*1 (degree):*10 ⁴			S/W stroke limit OK/NG setting	0: valid 1: invalid			Torque limit set value	012 012 012 012 1~500 [%]	15)	174 to 175	00AE to 00AF																																																									
Item				S/W stroke limit select																																																																																														
High Lmt			Axis 1	01234567890	Axis 2	01234567890	0	0	0	0																																																																																								
Low Lmt			Axis 3	01234567890	Axis 4	01234567890	0	0	0	0																																																																																								
Setting range			-2147483648 (μm):*10 ¹ (inch):*10 ⁻⁵ to 2147483647 (pulse):*1 (degree):*10 ⁴			S/W stroke limit OK/NG setting	0: valid 1: invalid			Torque limit set value	012 012 012 012 1~500 [%]																																																																																							
<p>QD75P/QD75D Detailed parameters 1-2</p> <table border="1"> <tr> <th colspan="4">Item</th> <th colspan="4">S/W stroke limit select</th> </tr> <tr> <td>High Lmt</td><td>Axis 1</td><td>01234567890</td> <td>Axis 2</td><td>01234567890</td> <td>0</td><td>0</td><td>0</td><td>0</td> </tr> <tr> <td>Low Lmt</td><td>Axis 3</td><td>01234567890</td> <td>Axis 4</td><td>01234567890</td> <td>0</td><td>0</td><td>0</td><td>0</td> </tr> <tr> <td>Setting range</td><td colspan="3">-2147483648 (μm):*10¹(inch):*10⁻⁵ to 2147483647 (pulse):*1 (degree):*10⁴</td> <td>S/W stroke limit OK/NG setting</td><td colspan="3">0: valid 1: invalid</td> <td>Torque limit set value</td><td>012 012 012 012 1~500 [%]</td> </tr> </table>			Item				S/W stroke limit select				High Lmt	Axis 1	01234567890	Axis 2	01234567890	0	0	0	0	Low Lmt	Axis 3	01234567890	Axis 4	01234567890	0	0	0	0	Setting range	-2147483648 (μm):*10 ¹ (inch):*10 ⁻⁵ to 2147483647 (pulse):*1 (degree):*10 ⁴			S/W stroke limit OK/NG setting	0: valid 1: invalid			Torque limit set value	012 012 012 012 1~500 [%]	16)	324 to 325	0144 to 0145																																																									
	Item				S/W stroke limit select																																																																																													
	High Lmt		Axis 1	01234567890	Axis 2	01234567890	0	0	0	0																																																																																								
	Low Lmt		Axis 3	01234567890	Axis 4	01234567890	0	0	0	0																																																																																								
	Setting range		-2147483648 (μm):*10 ¹ (inch):*10 ⁻⁵ to 2147483647 (pulse):*1 (degree):*10 ⁴			S/W stroke limit OK/NG setting	0: valid 1: invalid			Torque limit set value	012 012 012 012 1~500 [%]																																																																																							
	<p>QD75P/QD75D Detailed parameters 1-2</p> <table border="1"> <tr> <th colspan="4">Item</th> <th colspan="4">S/W stroke limit select</th> </tr> <tr> <td>High Lmt</td><td>Axis 1</td><td>01234567890</td> <td>Axis 2</td><td>01234567890</td> <td>0</td><td>0</td><td>0</td><td>0</td> </tr> <tr> <td>Low Lmt</td><td>Axis 3</td><td>01234567890</td> <td>Axis 4</td><td>01234567890</td> <td>0</td><td>0</td><td>0</td><td>0</td> </tr> <tr> <td>Setting range</td><td colspan="3">-2147483648 (μm):*10¹(inch):*10⁻⁵ to 2147483647 (pulse):*1 (degree):*10⁴</td> <td>S/W stroke limit OK/NG setting</td><td colspan="3">0: valid 1: invalid</td> <td>Torque limit set value</td><td>012 012 012 012 1~500 [%]</td> </tr> </table>		Item				S/W stroke limit select				High Lmt	Axis 1	01234567890	Axis 2	01234567890	0	0	0	0	Low Lmt	Axis 3	01234567890	Axis 4	01234567890	0	0	0	0	Setting range	-2147483648 (μm):*10 ¹ (inch):*10 ⁻⁵ to 2147483647 (pulse):*1 (degree):*10 ⁴			S/W stroke limit OK/NG setting	0: valid 1: invalid			Torque limit set value	012 012 012 012 1~500 [%]	17)	474 to 475	01DA to 01DB																																																									
		Item				S/W stroke limit select																																																																																												
		High Lmt	Axis 1	01234567890	Axis 2	01234567890	0	0	0	0																																																																																								
		Low Lmt	Axis 3	01234567890	Axis 4	01234567890	0	0	0	0																																																																																								
		Setting range	-2147483648 (μm):*10 ¹ (inch):*10 ⁻⁵ to 2147483647 (pulse):*1 (degree):*10 ⁴			S/W stroke limit OK/NG setting	0: valid 1: invalid			Torque limit set value	012 012 012 012 1~500 [%]																																																																																							
		<p>QD75P/QD75D Detailed parameters 1-2</p> <table border="1"> <tr> <th colspan="4">Item</th> <th colspan="4">S/W stroke limit select</th> </tr> <tr> <td>High Lmt</td><td>Axis 1</td><td>01234567890</td> <td>Axis 2</td><td>01234567890</td> <td>0</td><td>0</td><td>0</td><td>0</td> </tr> <tr> <td>Low Lmt</td><td>Axis 3</td><td>01234567890</td> <td>Axis 4</td><td>01234567890</td> <td>0</td><td>0</td><td>0</td><td>0</td> </tr> <tr> <td>Setting range</td><td colspan="3">-2147483648 (μm):*10¹(inch):*10⁻⁵ to 2147483647 (pulse):*1 (degree):*10⁴</td> <td>S/W stroke limit OK/NG setting</td><td colspan="3">0: valid 1: invalid</td> <td>Torque limit set value</td><td>012 012 012 012 1~500 [%]</td> </tr> </table>	Item				S/W stroke limit select				High Lmt	Axis 1	01234567890	Axis 2	01234567890	0	0	0	0	Low Lmt	Axis 3	01234567890	Axis 4	01234567890	0	0	0	0	Setting range	-2147483648 (μm):*10 ¹ (inch):*10 ⁻⁵ to 2147483647 (pulse):*1 (degree):*10 ⁴			S/W stroke limit OK/NG setting	0: valid 1: invalid			Torque limit set value	012 012 012 012 1~500 [%]	18)	30, 180, 330, 480	001E, 00B4, 014A, 01E0																																																									
Item				S/W stroke limit select																																																																																														
High Lmt			Axis 1	01234567890	Axis 2	01234567890	0	0	0	0																																																																																								
Low Lmt			Axis 3	01234567890	Axis 4	01234567890	0	0	0	0																																																																																								
Setting range			-2147483648 (μm):*10 ¹ (inch):*10 ⁻⁵ to 2147483647 (pulse):*1 (degree):*10 ⁴			S/W stroke limit OK/NG setting	0: valid 1: invalid			Torque limit set value	012 012 012 012 1~500 [%]																																																																																							
<p>QD75P/QD75D Detailed parameters 1-2</p> <table border="1"> <tr> <th colspan="4">Item</th> <th colspan="4">S/W stroke limit select</th> </tr> <tr> <td>High Lmt</td><td>Axis 1</td><td>01234567890</td> <td>Axis 2</td><td>01234567890</td> <td>0</td><td>0</td><td>0</td><td>0</td> </tr> <tr> <td>Low Lmt</td><td>Axis 3</td><td>01234567890</td> <td>Axis 4</td><td>01234567890</td> <td>0</td><td>0</td><td>0</td><td>0</td> </tr> <tr> <td>Setting range</td><td colspan="3">-2147483648 (μm):*10¹(inch):*10⁻⁵ to 2147483647 (pulse):*1 (degree):*10⁴</td> <td>S/W stroke limit OK/NG setting</td><td colspan="3">0: valid 1: invalid</td> <td>Torque limit set value</td><td>012 012 012 012 1~500 [%]</td> </tr> </table>			Item				S/W stroke limit select				High Lmt	Axis 1	01234567890	Axis 2	01234567890	0	0	0	0	Low Lmt	Axis 3	01234567890	Axis 4	01234567890	0	0	0	0	Setting range	-2147483648 (μm):*10 ¹ (inch):*10 ⁻⁵ to 2147483647 (pulse):*1 (degree):*10 ⁴			S/W stroke limit OK/NG setting	0: valid 1: invalid			Torque limit set value	012 012 012 012 1~500 [%]	19)	32, 182, 332, 482	0020, 00B6, 014C, 01E2																																																									
	Item				S/W stroke limit select																																																																																													
	High Lmt		Axis 1	01234567890	Axis 2	01234567890	0	0	0	0																																																																																								
	Low Lmt		Axis 3	01234567890	Axis 4	01234567890	0	0	0	0																																																																																								
	Setting range		-2147483648 (μm):*10 ¹ (inch):*10 ⁻⁵ to 2147483647 (pulse):*1 (degree):*10 ⁴			S/W stroke limit OK/NG setting	0: valid 1: invalid			Torque limit set value	012 012 012 012 1~500 [%]																																																																																							

Screen Image		No.	Buffer memory address																																																																																								
			dec.	hex.																																																																																							
<p>QD75P/QD75D Detailed parameters 2-1</p> <table border="1"> <tr> <th>Acc. time</th> <th>Axis1</th> <th>Axis2</th> <th>Axis3</th> <th>Axis4</th> </tr> <tr> <td>1</td> <td>0123456</td> <td>0123456</td> <td>0123456</td> <td>0123456</td> </tr> <tr> <td>2</td> <td>0123456</td> <td>0123456</td> <td>0123456</td> <td>0123456</td> </tr> <tr> <td>3</td> <td>0123456</td> <td>0123456</td> <td>0123456</td> <td>0123456</td> </tr> <tr> <td colspan="5">Setting range 1 to 8388608(msec)</td> </tr> </table> <table border="1"> <tr> <th colspan="5">JOG speed limit value</th> </tr> <tr> <th>Axis1</th> <th>Axis2</th> <th>Axis3</th> <th>Axis4</th> <th>Set range</th> </tr> <tr> <td>0123456789</td> <td>0123456789</td> <td>0123456789</td> <td>0123456789</td> <td>1 to 2000000000 (mm/min):*10⁻² (inch/min):*10⁻⁴ (degree/min):*10⁻⁴</td> </tr> <tr> <td colspan="5">Setting range 1 to 1000000 (pulse/sec):*1</td> </tr> </table> <table border="1"> <tr> <th>Dec. time</th> <th>Axis1</th> <th>Axis2</th> <th>Axis3</th> <th>Axis4</th> </tr> <tr> <td>1</td> <td>0123456</td> <td>0123456</td> <td>0123456</td> <td>0123456</td> </tr> <tr> <td>2</td> <td>0123456</td> <td>0123456</td> <td>0123456</td> <td>0123456</td> </tr> <tr> <td>3</td> <td>0123456</td> <td>0123456</td> <td>0123456</td> <td>0123456</td> </tr> <tr> <td colspan="5">Setting range 1 to 8388608(msec)</td> </tr> </table> <table border="1"> <tr> <th>Item</th> <th>Ax.1</th> <th>Ax.2</th> <th>Ax.3</th> <th>Ax.4</th> <th>Set range</th> </tr> <tr> <td>JOG accel. time select</td> <td>0</td> <td>0</td> <td>0</td> <td>0</td> <td>0 to 3</td> </tr> <tr> <td>JOG decel. time select</td> <td>0</td> <td>0</td> <td>0</td> <td>0</td> <td></td> </tr> </table>	Acc. time	Axis1	Axis2	Axis3	Axis4	1	0123456	0123456	0123456	0123456	2	0123456	0123456	0123456	0123456	3	0123456	0123456	0123456	0123456	Setting range 1 to 8388608(msec)					JOG speed limit value					Axis1	Axis2	Axis3	Axis4	Set range	0123456789	0123456789	0123456789	0123456789	1 to 2000000000 (mm/min):*10 ⁻² (inch/min):*10 ⁻⁴ (degree/min):*10 ⁻⁴	Setting range 1 to 1000000 (pulse/sec):*1					Dec. time	Axis1	Axis2	Axis3	Axis4	1	0123456	0123456	0123456	0123456	2	0123456	0123456	0123456	0123456	3	0123456	0123456	0123456	0123456	Setting range 1 to 8388608(msec)					Item	Ax.1	Ax.2	Ax.3	Ax.4	Set range	JOG accel. time select	0	0	0	0	0 to 3	JOG decel. time select	0	0	0	0		1)	36 to 41	0024 to 0029
	Acc. time	Axis1	Axis2	Axis3	Axis4																																																																																						
	1	0123456	0123456	0123456	0123456																																																																																						
	2	0123456	0123456	0123456	0123456																																																																																						
	3	0123456	0123456	0123456	0123456																																																																																						
	Setting range 1 to 8388608(msec)																																																																																										
	JOG speed limit value																																																																																										
	Axis1	Axis2	Axis3	Axis4	Set range																																																																																						
	0123456789	0123456789	0123456789	0123456789	1 to 2000000000 (mm/min):*10 ⁻² (inch/min):*10 ⁻⁴ (degree/min):*10 ⁻⁴																																																																																						
	Setting range 1 to 1000000 (pulse/sec):*1																																																																																										
	Dec. time	Axis1	Axis2	Axis3	Axis4																																																																																						
	1	0123456	0123456	0123456	0123456																																																																																						
	2	0123456	0123456	0123456	0123456																																																																																						
	3	0123456	0123456	0123456	0123456																																																																																						
	Setting range 1 to 8388608(msec)																																																																																										
Item	Ax.1	Ax.2	Ax.3	Ax.4	Set range																																																																																						
JOG accel. time select	0	0	0	0	0 to 3																																																																																						
JOG decel. time select	0	0	0	0																																																																																							
		186 to 191	00BA to 00BF																																																																																								
		336 to 341	0150 to 0155																																																																																								
		486 to 491	01E6 to 01EB																																																																																								
2)		42 to 47	002A to 002F																																																																																								
		192 to 197	00C0 to 00C5																																																																																								
		342 to 347	0156 to 015B																																																																																								
		492 to 496	01EC to 01F0																																																																																								
3)		48 to 49	0030 to 0031																																																																																								
		198 to 199	00C6 to 00C7																																																																																								
		348 to 349	015C to 015D																																																																																								
		498 to 499	01F2 to 01F3																																																																																								
4)		50, 200, 350, 500	0032, 00C8, 015E, 01F4																																																																																								
5)		51, 501, 351, 501	0033, 01F5, 015F, 01F5																																																																																								
<p>QD75P/QD75D Detailed parameters 2-2</p> <table border="1"> <tr> <th>Item</th> <th>Ax.1</th> <th>Ax.2</th> <th>Ax.3</th> <th>Ax.4</th> <th>Set range</th> </tr> <tr> <td>Acc/Dec selection</td> <td>0</td> <td>0</td> <td>0</td> <td>0</td> <td>0:Ramp 1:Curve</td> </tr> <tr> <td>S-pattern %</td> <td>012</td> <td>012</td> <td>012</td> <td>012</td> <td>1-100(%)</td> </tr> <tr> <td>Sudden stop decd. time</td> <td>1</td> <td>0</td> <td>0</td> <td>0</td> <td>0:Normal 1:Sudden stop</td> </tr> <tr> <td>Sudden stop deceleration time</td> <td>2</td> <td>0</td> <td>0</td> <td>0</td> <td></td> </tr> <tr> <td>Position complete signal output time</td> <td>3</td> <td>0</td> <td>0</td> <td>0</td> <td></td> </tr> </table> <table border="1"> <tr> <th colspan="5">Allowed circular int. error width</th> </tr> <tr> <th>Axis1</th> <th>Axis2</th> <th>Axis3</th> <th>Axis4</th> <th>Set range</th> </tr> <tr> <td>012345</td> <td>012345</td> <td>012345</td> <td>012345</td> <td>0 to 100000 (μm):*10⁻¹ (inch):*10⁻⁴ (degree):*10⁻⁴ (pulse):*1</td> </tr> <tr> <td colspan="5">Setting range 0 to 100000</td> </tr> </table> <table border="1"> <tr> <th colspan="5">External command function selection</th> </tr> <tr> <th>Axis1</th> <th>Axis2</th> <th>Axis3</th> <th>Axis4</th> <th>Set range</th> </tr> <tr> <td>1</td> <td>0</td> <td>0</td> <td>0</td> <td>0</td> </tr> <tr> <td colspan="5">Setting range 0:External positioning start 1:External speed change request 2:Speed-position, position-speed switching request 3:Skip request</td> </tr> </table>	Item	Ax.1	Ax.2	Ax.3	Ax.4	Set range	Acc/Dec selection	0	0	0	0	0:Ramp 1:Curve	S-pattern %	012	012	012	012	1-100(%)	Sudden stop decd. time	1	0	0	0	0:Normal 1:Sudden stop	Sudden stop deceleration time	2	0	0	0		Position complete signal output time	3	0	0	0		Allowed circular int. error width					Axis1	Axis2	Axis3	Axis4	Set range	012345	012345	012345	012345	0 to 100000 (μm):*10 ⁻¹ (inch):*10 ⁻⁴ (degree):*10 ⁻⁴ (pulse):*1	Setting range 0 to 100000					External command function selection					Axis1	Axis2	Axis3	Axis4	Set range	1	0	0	0	0	Setting range 0:External positioning start 1:External speed change request 2:Speed-position, position-speed switching request 3:Skip request					1)	52, 202, 352, 502	0034, 00CA, 0160, 01F6												
	Item	Ax.1	Ax.2	Ax.3	Ax.4	Set range																																																																																					
	Acc/Dec selection	0	0	0	0	0:Ramp 1:Curve																																																																																					
	S-pattern %	012	012	012	012	1-100(%)																																																																																					
	Sudden stop decd. time	1	0	0	0	0:Normal 1:Sudden stop																																																																																					
	Sudden stop deceleration time	2	0	0	0																																																																																						
	Position complete signal output time	3	0	0	0																																																																																						
	Allowed circular int. error width																																																																																										
	Axis1	Axis2	Axis3	Axis4	Set range																																																																																						
	012345	012345	012345	012345	0 to 100000 (μm):*10 ⁻¹ (inch):*10 ⁻⁴ (degree):*10 ⁻⁴ (pulse):*1																																																																																						
	Setting range 0 to 100000																																																																																										
	External command function selection																																																																																										
	Axis1	Axis2	Axis3	Axis4	Set range																																																																																						
	1	0	0	0	0																																																																																						
	Setting range 0:External positioning start 1:External speed change request 2:Speed-position, position-speed switching request 3:Skip request																																																																																										
		53, 203, 353, 503	0035, 00CB, 0161, 01F7																																																																																								
		56, 206, 356, 506	0038, 00CE, 0164, 01FA																																																																																								
		57, 207, 357, 507	0039, 00CF, 0165, 01FB																																																																																								
		58, 208, 358, 508	003A, 00D0, 0166, 01FC																																																																																								
		54, 204, 354, 504	0036, 00CC, 0162, 01F8																																																																																								
		59, 209, 359, 509	003B, 00D1, 0167, 01FD																																																																																								
8)		60 to 61	003C to 003D																																																																																								
		210 to 211	00D2 to 00D3																																																																																								
		360 to 361	0168 to 0169																																																																																								
		510 to 511	01FE to 01FF																																																																																								
9)		62, 212, 362, 512	003E, 00D4, 016A, 0200																																																																																								

Screen Image		No.	Buffer memory address	
			dec.	hex.
		1)	79, 229, 379, 529	004F, 00E5, 017B, 0211
		2)	82, 232, 382, 532	0052, 00E8, 017E, 0214
		3)	83, 233, 383, 533	0053, 00E9, 017F, 0215
		4)	86, 236, 386, 536	0056, 00EC, 0182, 0218
		5)	80 to 81	0050 to 0051
			230 to 231	00E6 to 00E7
			380 to 381	017C to 017D
		6)	530 to 531	0212 to 0213
			84 to 85	0054 to 0055
234 to 235	00EA to 00EB			
7)	384 to 385	0180 to 0181		
	534 to 535	0216 to 0217		
	87, 237, 387, 537	0057, 00ED, 0183, 0219		
8)	88, 238, 388, 538	0058, 00EE, 0184, 021A		
	89, 239, 389, 539	0059, 00EF, 0185, 021B		
		1)	70, 220, 370, 520	0046, 00DC, 0172, 0208
		2)	71, 221, 371, 521	0047, 00DD, 0173, 0209
		3)	78, 228, 378, 528	004E, 00E4, 017A, 0210
			72 to 73	0048 to 0049
		4)	222 to 223	00DE to 00DF
			372 to 373	0174 to 0175
			522 to 523	020A to 020B
		5)	74 to 75	004A to 004B
			224 to 225	00E0 to 00E1
			374 to 375	0176 to 0177
		6)	524 to 525	020C to 020D
			76 to 77	004C to 004D
			226 to 227	00E2 to 00E3
			376 to 377	0178 to 0179
		526 to 527	020E to 020F	

Screen Image	No.	Buffer memory address	
		dec.	hex.
	1)	816, 916, 1016, 1116	0330, 0394, 03F8, 045C
	2)	817, 917, 1017, 1117	0331, 0395, 03F9, 045D
	1)	818 to 819	0332 to 0333
	2)	918 to 919	0396 to 0397
	3)	1018 to 1019	03FA to 03FB
	4)	1118 to 1119	045E to 045F
	5)	802 to 803	0322 to 0323
	6)	902 to 903	0386 to 0387
	7)	1002 to 1003	03EA to 03EB
	8)	1102 to 1103	044E to 044F
	9)	820 to 821	0334 to 0335
	10)	920 to 921	0398 to 0399
	11)	1020 to 1021	03FC to 03FD
	12)	1120 to 1121	0460 to 0461
	13)	810 to 811	032A to 032B
	14)	910 to 911	038E to 038F
	15)	1010 to 1011	03F2 to 03F3
	16)	1110 to 1111	0456 to 0457
	17)	812 to 813	032C to 032D
	18)	912 to 913	0390 to 0391
	19)	1012 to 1013	03F4 to 03F5
	20)	1112 to 1113	0458 to 0459
21)	830, 930, 1030, 1130	033E, 03A2, 0406, 046A	
22)	831, 931, 1031, 1131	033F, 03A3, 0407, 046B	

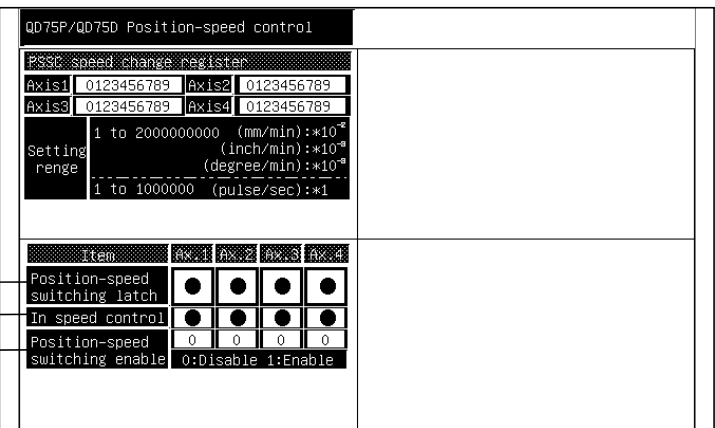
Screen Image	No.	Buffer memory address	
		dec.	hex.
	1)	827, 927, 1027, 1127	033B, 039F, 0403, 0467
	2)	828, 928, 1028, 1128	033C, 03A0, 0404, 0468
	3)	829, 929, 1029, 1129	033D, 03A1, 0405, 0469
	4)	834, 934, 1034, 1134	0342, 03A6, 040A, 046E
	5)	835, 936, 1036, 1135	0343, 03A8, 040C, 046F
	6)	836, 936, 1036, 1136	0344, 03A8, 040C, 0470
	7)	837, 937, 1037, 1137	0345, 03A9, 040D, 0471
	8)	832, 932, 1032, 1132	0340, 03A4, 0408, 046C
	9)	833, 933, 1033, 1133	0341, 03A5, 0409, 046D
	1)	824 to 825 924 to 925 1024 to 1025 1124 to 1125	0338 to 0339 039C to 039D 0400 to 0401 0464 to 0465
	2)	826, 926, 1026, 1126	033A, 039E, 0402, 0466
	3)	816, 916, 1016, 1116	0330, 0394, 03F8, 045C
	4)	814 to 815	032E to 032F
	5)	914 to 915	0392 to 0393
	6)	1014 to 1015	03F6 to 03F7
	1)	1014 to 1015 1114 to 1115	03F6 to 03F7 045A to 045B
	2)	1526 to 1527 1626 to 1627 1726 to 1727 1826 to 1827	05F6 to 05F7 065A to 065B 06BE to 06BF 0722 to 0723
	3)	817, 917, 1017, 1117	0331, 0395, 03F9, 045D
	4)	817, 917, 1017, 1117	0331, 0395, 03F9, 045D
	5)	1528, 1628, 1728, 1828	05F8, 065C, 06C0, 0724

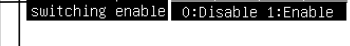
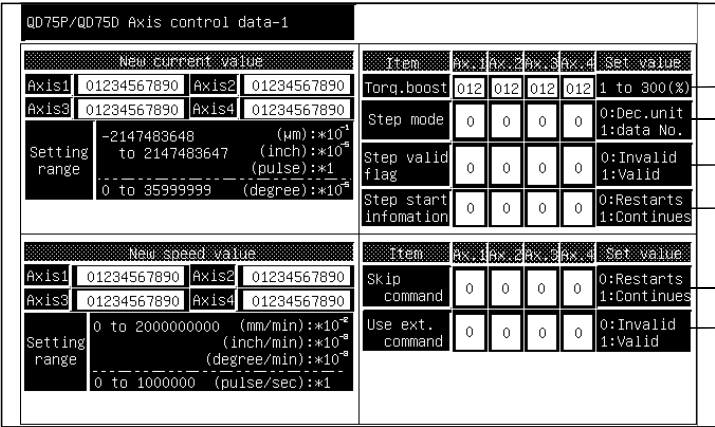
Screen Image	No.	Buffer memory address		
		dec.	hex.	
<p>1) </p>	1)	1530 to 1531	05FA to 05FB	
		1630 to 1631	065E to 065F	
		1730 to 1731	06C2 to 06C3	
		1830 to 1831	0726 to 0727	
<p>2) </p> <p>3) </p> <p>4) </p>	2)	817, 917, 1017, 1117	0331, 0395, 03F9, 045D	
		3)	817, 917, 1017, 1117	0331, 0395, 03F9, 045D
			4)	1532, 1632, 1732, 1832
		—		—
<p>1) </p>	1)	1506 to 1507	05E2 to 05E3	
		1606 to 1607	0646 to 0647	
		1706 to 1707	06AA to 06AB	
		1806 to 1807	070E to 070F	
	2)	2)	1514 to 1515	05EA to 05EB
			1614 to 1615	064E to 064F
			1714 to 1715	06B2 to 06B3
			1814 to 1815	0716 to 0717
	3)	3)	1513, 1613, 1713, 1813	05E9, 064D, 06B1, 0715
			4)	4)
	5)	5)		
			6)	6)
	7)	7)		
			8)	8)

Screen Image		No.	Buffer memory address	
			dec.	hex.
		1)	1500, 1600, 1700, 1800	05DC, 0640, 06A4, 0708
		2)	1501, 1601, 1701, 1801	05DD, 0641, 06A5, 0709
		3)	1502, 1602, 1702, 1802	05DE, 0642, 06A6, 070A
		4)	1503, 1603, 1703, 1803	05DF, 0643, 06A7, 070B
		5)	1504, 1604, 1704, 1804	05E0, 0644, 06A8, 070C
		6)	1512, 1612, 1712, 1812	05E8, 064C, 06B0, 0714
		7)	1516, 1616, 1716, 1816	05EC, 0650, 06B4, 0718
		8)	1508 to 1509	05E4 to 05E5
			1608 to 1609	0648 to 0649
			1708 to 1709	06AC to 06AD
			1808 to 1809	0710 to 0711
		9)	1510 to 1511	05E6 to 05E7
			1610 to 1611	064A to 064B
			1710 to 1711	06AE to 06AF
10)	1510 to 1511	05E6 to 05E7		
	1610 to 1611	064A to 064B		
	1710 to 1711	06AE to 06AF		
11)	1520, 1620, 1720, 1820	05F0, 0654, 06B8, 071C		
	1521, 1621, 1721, 1821	05F1, 0655, 06B9, 071D		
	1522 to 1523	05F2 to 05F3		
12)	1622 to 1623	0656 to 0657		
	1722 to 1723	06BA to 06BB		
	1822 to 1823	071E to 071F		
13)	1524, 1624, 1724, 1824	05F4, 0658, 06BC, 0720		
14)	1525, 1625, 1725, 1825	05F5, 0659, 06BD, 0721		
		1)	1538, 1638, 1738, 1838	0602, 0666, 06CA, 072E
		2)	1548, 1648, 1748, 1848	060C, 0670, 06D4, 0738
		3)	1549, 1649, 1749, 1849	060D, 0671, 06D5, 0739
		4)	1550, 1650, 1750, 1850	060E, 0672, 06D6, 073A
		5)	1540, 1640, 1740, 1840, 1541, 1641, 1741, 1841, 1542, 1642, 1742, 1842, 1543, 1643, 1743, 1843	0604, 0668, 06CC, 0730, 0605, 0669, 06CD, 0731, 0606, 066A, 06CE, 0732, 0607, 066B, 06CF, 0733

Screen Image		No.	Buffer memory address																																																																																																																																																
			dec.	hex.																																																																																																																																															
<p>QD75P/QD75D Axis control data-4</p> <p>Inching movement amount</p> <table border="1"> <tr><td>Axis1</td><td>01234</td><td>Axis2</td><td>01234</td></tr> <tr><td>Axis3</td><td>01234</td><td>Axis4</td><td>01234</td></tr> </table> <p>Setting range: 1 to 65535 (mm):*10⁻⁴ [inch]:*10⁻⁴ (degree):*10⁻⁴ [pulse]:*1 0:JOG operation</p> <p>Target position change value (Address)</p> <table border="1"> <tr><td>Axis1</td><td>0123456789</td><td>Axis2</td><td>0123456789</td></tr> <tr><td>Axis3</td><td>0123456789</td><td>Axis4</td><td>0123456789</td></tr> </table> <p>Setting range: ABS-INC -2147483648 to 2147483647 (μm):*10⁻⁴ (inch):*10⁻⁴ (degree):*10⁻⁴ (pulse):*1 (*ABS 0to3599999(degree):*10⁻⁴)</p> <p>JOG speed</p> <table border="1"> <tr><td>Axis1</td><td>0123456789</td><td>Axis2</td><td>0123456789</td></tr> <tr><td>Axis3</td><td>0123456789</td><td>Axis4</td><td>0123456789</td></tr> </table> <p>Setting range: 0 to 2000000000 (mm/min):*10⁻² (inch/min):*10⁻² (degree/min):*10⁻² 0 to 1000000 (pulse/sec):*1</p> <p>Target position change value (Speed)</p> <table border="1"> <tr><td>Axis1</td><td>0123456789</td><td>Axis2</td><td>0123456789</td></tr> <tr><td>Axis3</td><td>0123456789</td><td>Axis4</td><td>0123456789</td></tr> </table> <p>Setting range: 0 to 2000000000 (mm/min):*10⁻² (inch/min):*10⁻² (degree/min):*10⁻² 0 to 1000000 (pulse/sec):*1</p>	Axis1	01234	Axis2	01234	Axis3	01234	Axis4	01234	Axis1	0123456789	Axis2	0123456789	Axis3	0123456789	Axis4	0123456789	Axis1	0123456789	Axis2	0123456789	Axis3	0123456789	Axis4	0123456789	Axis1	0123456789	Axis2	0123456789	Axis3	0123456789	Axis4	0123456789	1)	1517, 1617, 1717, 1817	05ED, 0651, 06B5, 0719																																																																																																																
	Axis1	01234	Axis2	01234																																																																																																																																															
	Axis3	01234	Axis4	01234																																																																																																																																															
	Axis1	0123456789	Axis2	0123456789																																																																																																																																															
	Axis3	0123456789	Axis4	0123456789																																																																																																																																															
	Axis1	0123456789	Axis2	0123456789																																																																																																																																															
	Axis3	0123456789	Axis4	0123456789																																																																																																																																															
	Axis1	0123456789	Axis2	0123456789																																																																																																																																															
	Axis3	0123456789	Axis4	0123456789																																																																																																																																															
		2)	1518 to 1519	05EE to 05EF																																																																																																																																															
		3)	1618 to 1619	0652 to 0653																																																																																																																																															
		3)	1718 to 1719	06B6 to 06B7																																																																																																																																															
	3)	1818 to 1819	071A to 071B																																																																																																																																																
	3)	1534 to 1535	05FE to 05FF																																																																																																																																																
	3)	1634 to 1635	0662 to 0663																																																																																																																																																
	3)	1734 to 1735	06C6 to 06C7																																																																																																																																																
	3)	1834 to 1835	072A to 072B																																																																																																																																																
	4)	1536 to 1537	0600 to 0601																																																																																																																																																
	4)	1636 to 1637	0664 to 0665																																																																																																																																																
	4)	1736 to 1737	06C8 to 06C9																																																																																																																																																
	4)	1836 to 1837	072C to 072D																																																																																																																																																
<p>QD75P/QD75D Start History</p> <p>Start History (0 to 7)</p> <table border="1"> <tr><th>No.</th><th>Axis</th><th>Start</th><th>Kind</th><th>Time</th><th>Judge</th></tr> <tr><td>0</td><td>01</td><td>0123</td><td></td><td>00:00:00.00</td><td>012</td></tr> <tr><td>1</td><td>01</td><td>0123</td><td></td><td>00:00:00.00</td><td>012</td></tr> <tr><td>2</td><td>01</td><td>0123</td><td></td><td>00:00:00.00</td><td>012</td></tr> <tr><td>3</td><td>01</td><td>0123</td><td></td><td>00:00:00.00</td><td>012</td></tr> <tr><td>4</td><td>01</td><td>0123</td><td></td><td>00:00:00.00</td><td>012</td></tr> <tr><td>5</td><td>01</td><td>0123</td><td></td><td>00:00:00.00</td><td>012</td></tr> <tr><td>6</td><td>01</td><td>0123</td><td></td><td>00:00:00.00</td><td>012</td></tr> <tr><td>7</td><td>01</td><td>0123</td><td></td><td>00:00:00.00</td><td>012</td></tr> </table> <p>Start History (8 to 15)</p> <table border="1"> <tr><th>No.</th><th>Axis</th><th>Start</th><th>Kind</th><th>Time</th><th>Judge</th></tr> <tr><td>8</td><td>01</td><td>0123</td><td></td><td>00:00:00.00</td><td>012</td></tr> <tr><td>9</td><td>01</td><td>0123</td><td></td><td>00:00:00.00</td><td>012</td></tr> <tr><td>10</td><td>01</td><td>0123</td><td></td><td>00:00:00.00</td><td>012</td></tr> <tr><td>11</td><td>01</td><td>0123</td><td></td><td>00:00:00.00</td><td>012</td></tr> <tr><td>12</td><td>01</td><td>0123</td><td></td><td>00:00:00.00</td><td>012</td></tr> <tr><td>13</td><td>01</td><td>0123</td><td></td><td>00:00:00.00</td><td>012</td></tr> <tr><td>14</td><td>01</td><td>0123</td><td></td><td>00:00:00.00</td><td>012</td></tr> <tr><td>15</td><td>01</td><td>0123</td><td></td><td>00:00:00.00</td><td>012</td></tr> </table>	No.	Axis	Start	Kind	Time	Judge	0	01	0123		00:00:00.00	012	1	01	0123		00:00:00.00	012	2	01	0123		00:00:00.00	012	3	01	0123		00:00:00.00	012	4	01	0123		00:00:00.00	012	5	01	0123		00:00:00.00	012	6	01	0123		00:00:00.00	012	7	01	0123		00:00:00.00	012	No.	Axis	Start	Kind	Time	Judge	8	01	0123		00:00:00.00	012	9	01	0123		00:00:00.00	012	10	01	0123		00:00:00.00	012	11	01	0123		00:00:00.00	012	12	01	0123		00:00:00.00	012	13	01	0123		00:00:00.00	012	14	01	0123		00:00:00.00	012	15	01	0123		00:00:00.00	012	1)	1212 to 1292	04BC to 050C																																				
	No.	Axis	Start	Kind	Time	Judge																																																																																																																																													
0	01	0123		00:00:00.00	012																																																																																																																																														
1	01	0123		00:00:00.00	012																																																																																																																																														
2	01	0123		00:00:00.00	012																																																																																																																																														
3	01	0123		00:00:00.00	012																																																																																																																																														
4	01	0123		00:00:00.00	012																																																																																																																																														
5	01	0123		00:00:00.00	012																																																																																																																																														
6	01	0123		00:00:00.00	012																																																																																																																																														
7	01	0123		00:00:00.00	012																																																																																																																																														
No.	Axis	Start	Kind	Time	Judge																																																																																																																																														
8	01	0123		00:00:00.00	012																																																																																																																																														
9	01	0123		00:00:00.00	012																																																																																																																																														
10	01	0123		00:00:00.00	012																																																																																																																																														
11	01	0123		00:00:00.00	012																																																																																																																																														
12	01	0123		00:00:00.00	012																																																																																																																																														
13	01	0123		00:00:00.00	012																																																																																																																																														
14	01	0123		00:00:00.00	012																																																																																																																																														
15	01	0123		00:00:00.00	012																																																																																																																																														
		---	---																																																																																																																																																
<p>QD75P/QD75D Error & Warning History</p> <p>Error History (0 to 7)</p> <table border="1"> <tr><th>No.</th><th>Axis</th><th>Code</th><th>Time</th></tr> <tr><td>0</td><td>012</td><td></td><td>00:00:00.00</td></tr> <tr><td>1</td><td>012</td><td></td><td>00:00:00.00</td></tr> <tr><td>2</td><td>012</td><td></td><td>00:00:00.00</td></tr> <tr><td>3</td><td>012</td><td></td><td>00:00:00.00</td></tr> <tr><td>4</td><td>012</td><td></td><td>00:00:00.00</td></tr> <tr><td>5</td><td>012</td><td></td><td>00:00:00.00</td></tr> <tr><td>6</td><td>012</td><td></td><td>00:00:00.00</td></tr> <tr><td>7</td><td>012</td><td></td><td>00:00:00.00</td></tr> </table> <p>Warning History (0 to 7)</p> <table border="1"> <tr><th>No.</th><th>Axis</th><th>Code</th><th>Time</th></tr> <tr><td>0</td><td>012</td><td></td><td>00:00:00.00</td></tr> <tr><td>1</td><td>012</td><td></td><td>00:00:00.00</td></tr> <tr><td>2</td><td>012</td><td></td><td>00:00:00.00</td></tr> <tr><td>3</td><td>012</td><td></td><td>00:00:00.00</td></tr> <tr><td>4</td><td>012</td><td></td><td>00:00:00.00</td></tr> <tr><td>5</td><td>012</td><td></td><td>00:00:00.00</td></tr> <tr><td>6</td><td>012</td><td></td><td>00:00:00.00</td></tr> <tr><td>7</td><td>012</td><td></td><td>00:00:00.00</td></tr> </table> <p>Error History (8 to 15)</p> <table border="1"> <tr><th>No.</th><th>Axis</th><th>Code</th><th>Time</th></tr> <tr><td>8</td><td>012</td><td></td><td>00:00:00.00</td></tr> <tr><td>9</td><td>012</td><td></td><td>00:00:00.00</td></tr> <tr><td>10</td><td>012</td><td></td><td>00:00:00.00</td></tr> <tr><td>11</td><td>012</td><td></td><td>00:00:00.00</td></tr> <tr><td>12</td><td>012</td><td></td><td>00:00:00.00</td></tr> <tr><td>13</td><td>012</td><td></td><td>00:00:00.00</td></tr> <tr><td>14</td><td>012</td><td></td><td>00:00:00.00</td></tr> <tr><td>15</td><td>012</td><td></td><td>00:00:00.00</td></tr> </table> <p>Warning History (8 to 15)</p> <table border="1"> <tr><th>No.</th><th>Axis</th><th>Code</th><th>Time</th></tr> <tr><td>8</td><td>012</td><td></td><td>00:00:00.00</td></tr> <tr><td>9</td><td>012</td><td></td><td>00:00:00.00</td></tr> <tr><td>10</td><td>012</td><td></td><td>00:00:00.00</td></tr> <tr><td>11</td><td>012</td><td></td><td>00:00:00.00</td></tr> <tr><td>12</td><td>012</td><td></td><td>00:00:00.00</td></tr> <tr><td>13</td><td>012</td><td></td><td>00:00:00.00</td></tr> <tr><td>14</td><td>012</td><td></td><td>00:00:00.00</td></tr> <tr><td>15</td><td>012</td><td></td><td>00:00:00.00</td></tr> </table>	No.	Axis	Code	Time	0	012		00:00:00.00	1	012		00:00:00.00	2	012		00:00:00.00	3	012		00:00:00.00	4	012		00:00:00.00	5	012		00:00:00.00	6	012		00:00:00.00	7	012		00:00:00.00	No.	Axis	Code	Time	0	012		00:00:00.00	1	012		00:00:00.00	2	012		00:00:00.00	3	012		00:00:00.00	4	012		00:00:00.00	5	012		00:00:00.00	6	012		00:00:00.00	7	012		00:00:00.00	No.	Axis	Code	Time	8	012		00:00:00.00	9	012		00:00:00.00	10	012		00:00:00.00	11	012		00:00:00.00	12	012		00:00:00.00	13	012		00:00:00.00	14	012		00:00:00.00	15	012		00:00:00.00	No.	Axis	Code	Time	8	012		00:00:00.00	9	012		00:00:00.00	10	012		00:00:00.00	11	012		00:00:00.00	12	012		00:00:00.00	13	012		00:00:00.00	14	012		00:00:00.00	15	012		00:00:00.00	1)	1293 to 1356	050D to 054C
	No.	Axis	Code	Time																																																																																																																																															
	0	012		00:00:00.00																																																																																																																																															
	1	012		00:00:00.00																																																																																																																																															
2	012		00:00:00.00																																																																																																																																																
3	012		00:00:00.00																																																																																																																																																
4	012		00:00:00.00																																																																																																																																																
5	012		00:00:00.00																																																																																																																																																
6	012		00:00:00.00																																																																																																																																																
7	012		00:00:00.00																																																																																																																																																
No.	Axis	Code	Time																																																																																																																																																
0	012		00:00:00.00																																																																																																																																																
1	012		00:00:00.00																																																																																																																																																
2	012		00:00:00.00																																																																																																																																																
3	012		00:00:00.00																																																																																																																																																
4	012		00:00:00.00																																																																																																																																																
5	012		00:00:00.00																																																																																																																																																
6	012		00:00:00.00																																																																																																																																																
7	012		00:00:00.00																																																																																																																																																
No.	Axis	Code	Time																																																																																																																																																
8	012		00:00:00.00																																																																																																																																																
9	012		00:00:00.00																																																																																																																																																
10	012		00:00:00.00																																																																																																																																																
11	012		00:00:00.00																																																																																																																																																
12	012		00:00:00.00																																																																																																																																																
13	012		00:00:00.00																																																																																																																																																
14	012		00:00:00.00																																																																																																																																																
15	012		00:00:00.00																																																																																																																																																
No.	Axis	Code	Time																																																																																																																																																
8	012		00:00:00.00																																																																																																																																																
9	012		00:00:00.00																																																																																																																																																
10	012		00:00:00.00																																																																																																																																																
11	012		00:00:00.00																																																																																																																																																
12	012		00:00:00.00																																																																																																																																																
13	012		00:00:00.00																																																																																																																																																
14	012		00:00:00.00																																																																																																																																																
15	012		00:00:00.00																																																																																																																																																
	2)	1358 to 1421	054E to 058D																																																																																																																																																
		---	---																																																																																																																																																

Screen Image	No.	Buffer memory address																																																																																																																																																																																																																																																																																																																																																																																					
		dec.	hex.																																																																																																																																																																																																																																																																																																																																																																																				
<div style="border: 1px solid black; padding: 5px;"> <p>QD75P/QD75D Positioning data</p> <table border="1" style="width: 100%; border-collapse: collapse;"> <thead> <tr> <th colspan="10">Axis1</th> <th colspan="10">Axis3</th> </tr> <tr> <th>No.</th><th>Part</th><th>Int.</th><th>Cont.</th><th>Acc.</th><th>Dec.</th><th>Dwell</th><th>Mcode</th><th colspan="2"></th> <th>No.</th><th>Part</th><th>Int.</th><th>Cont.</th><th>Acc.</th><th>Dec.</th><th>Dwell</th><th>Mcode</th><th colspan="2"></th> </tr> <tr> <th colspan="2"></th><th>Address</th><th>Arc address</th><th colspan="2">Instn. speed</th><th colspan="2"></th><th colspan="2"></th> <th colspan="2"></th><th>Address</th><th>Arc address</th><th colspan="2">Instn. speed</th><th colspan="2"></th><th colspan="2"></th> </tr> </thead> <tbody> <tr> <td></td><td>01</td><td>01</td><td>01</td><td>01</td><td>01</td><td>01</td><td>01234</td><td>01234</td><td></td> <td></td><td>01</td><td>01</td><td>01</td><td>01</td><td>01</td><td>01</td><td>01234</td><td>01234</td><td></td><td></td> </tr> <tr> <td></td><td>01234567890</td><td>01234567890</td><td>01234567890</td><td>01234567890</td><td>01234567890</td><td>01234567890</td><td>01234567890</td><td>01234567890</td><td></td> <td></td><td>01234567890</td><td>01234567890</td><td>01234567890</td><td>01234567890</td><td>01234567890</td><td>01234567890</td><td>01234567890</td><td>01234567890</td><td></td><td></td> </tr> <tr> <td></td><td>01</td><td>01</td><td>01</td><td>01</td><td>01</td><td>01</td><td>01234</td><td>01234</td><td></td> <td></td><td>01</td><td>01</td><td>01</td><td>01</td><td>01</td><td>01</td><td>01234</td><td>01234</td><td></td><td></td> </tr> <tr> <td></td><td>01234567890</td><td>01234567890</td><td>01234567890</td><td>01234567890</td><td>01234567890</td><td>01234567890</td><td>01234567890</td><td>01234567890</td><td></td> <td></td><td>01234567890</td><td>01234567890</td><td>01234567890</td><td>01234567890</td><td>01234567890</td><td>01234567890</td><td>01234567890</td><td>01234567890</td><td></td><td></td> </tr> <tr> <td></td><td>01</td><td>01</td><td>01</td><td>01</td><td>01</td><td>01</td><td>01234</td><td>01234</td><td></td> <td></td><td>01</td><td>01</td><td>01</td><td>01</td><td>01</td><td>01</td><td>01234</td><td>01234</td><td></td><td></td> </tr> <tr> <td></td><td>01234567890</td><td>01234567890</td><td>01234567890</td><td>01234567890</td><td>01234567890</td><td>01234567890</td><td>01234567890</td><td>01234567890</td><td></td> <td></td><td>01234567890</td><td>01234567890</td><td>01234567890</td><td>01234567890</td><td>01234567890</td><td>01234567890</td><td>01234567890</td><td>01234567890</td><td></td><td></td> </tr> </tbody> </table> <table border="1" style="width: 100%; border-collapse: collapse;"> <thead> <tr> <th colspan="10">Axis2</th> <th colspan="10">Axis4</th> </tr> <tr> <th>No.</th><th>Part</th><th>Int.</th><th>Cont.</th><th>Acc.</th><th>Dec.</th><th>Dwell</th><th>Mcode</th><th colspan="2"></th> <th>No.</th><th>Part</th><th>Int.</th><th>Cont.</th><th>Acc.</th><th>Dec.</th><th>Dwell</th><th>Mcode</th><th colspan="2"></th> </tr> <tr> <th colspan="2"></th><th>Address</th><th>Arc address</th><th colspan="2">Instn. speed</th><th colspan="2"></th><th colspan="2"></th> <th colspan="2"></th><th>Address</th><th>Arc address</th><th colspan="2">Instn. speed</th><th colspan="2"></th><th colspan="2"></th> </tr> </thead> <tbody> <tr> <td></td><td>01</td><td>01</td><td>01</td><td>01</td><td>01</td><td>01</td><td>01234</td><td>01234</td><td></td> <td></td><td>01</td><td>01</td><td>01</td><td>01</td><td>01</td><td>01</td><td>01234</td><td>01234</td><td></td><td></td> </tr> <tr> <td></td><td>01234567890</td><td>01234567890</td><td>01234567890</td><td>01234567890</td><td>01234567890</td><td>01234567890</td><td>01234567890</td><td>01234567890</td><td></td> <td></td><td>01234567890</td><td>01234567890</td><td>01234567890</td><td>01234567890</td><td>01234567890</td><td>01234567890</td><td>01234567890</td><td>01234567890</td><td></td><td></td> </tr> <tr> <td></td><td>01</td><td>01</td><td>01</td><td>01</td><td>01</td><td>01</td><td>01234</td><td>01234</td><td></td> <td></td><td>01</td><td>01</td><td>01</td><td>01</td><td>01</td><td>01</td><td>01234</td><td>01234</td><td></td><td></td> </tr> <tr> <td></td><td>01234567890</td><td>01234567890</td><td>01234567890</td><td>01234567890</td><td>01234567890</td><td>01234567890</td><td>01234567890</td><td>01234567890</td><td></td> <td></td><td>01234567890</td><td>01234567890</td><td>01234567890</td><td>01234567890</td><td>01234567890</td><td>01234567890</td><td>01234567890</td><td>01234567890</td><td></td><td></td> </tr> <tr> <td></td><td>01</td><td>01</td><td>01</td><td>01</td><td>01</td><td>01</td><td>01234</td><td>01234</td><td></td> <td></td><td>01</td><td>01</td><td>01</td><td>01</td><td>01</td><td>01</td><td>01234</td><td>01234</td><td></td><td></td> </tr> <tr> <td></td><td>01234567890</td><td>01234567890</td><td>01234567890</td><td>01234567890</td><td>01234567890</td><td>01234567890</td><td>01234567890</td><td>01234567890</td><td></td> <td></td><td>01234567890</td><td>01234567890</td><td>01234567890</td><td>01234567890</td><td>01234567890</td><td>01234567890</td><td>01234567890</td><td>01234567890</td><td></td><td></td> </tr> </tbody> </table> </div>	Axis1										Axis3										No.	Part	Int.	Cont.	Acc.	Dec.	Dwell	Mcode			No.	Part	Int.	Cont.	Acc.	Dec.	Dwell	Mcode					Address	Arc address	Instn. speed								Address	Arc address	Instn. speed							01	01	01	01	01	01	01234	01234			01	01	01	01	01	01	01234	01234				01234567890	01234567890	01234567890	01234567890	01234567890	01234567890	01234567890	01234567890			01234567890	01234567890	01234567890	01234567890	01234567890	01234567890	01234567890	01234567890				01	01	01	01	01	01	01234	01234			01	01	01	01	01	01	01234	01234				01234567890	01234567890	01234567890	01234567890	01234567890	01234567890	01234567890	01234567890			01234567890	01234567890	01234567890	01234567890	01234567890	01234567890	01234567890	01234567890				01	01	01	01	01	01	01234	01234			01	01	01	01	01	01	01234	01234				01234567890	01234567890	01234567890	01234567890	01234567890	01234567890	01234567890	01234567890			01234567890	01234567890	01234567890	01234567890	01234567890	01234567890	01234567890	01234567890			Axis2										Axis4										No.	Part	Int.	Cont.	Acc.	Dec.	Dwell	Mcode			No.	Part	Int.	Cont.	Acc.	Dec.	Dwell	Mcode					Address	Arc address	Instn. speed								Address	Arc address	Instn. speed							01	01	01	01	01	01	01234	01234			01	01	01	01	01	01	01234	01234				01234567890	01234567890	01234567890	01234567890	01234567890	01234567890	01234567890	01234567890			01234567890	01234567890	01234567890	01234567890	01234567890	01234567890	01234567890	01234567890				01	01	01	01	01	01	01234	01234			01	01	01	01	01	01	01234	01234				01234567890	01234567890	01234567890	01234567890	01234567890	01234567890	01234567890	01234567890			01234567890	01234567890	01234567890	01234567890	01234567890	01234567890	01234567890	01234567890				01	01	01	01	01	01	01234	01234			01	01	01	01	01	01	01234	01234				01234567890	01234567890	01234567890	01234567890	01234567890	01234567890	01234567890	01234567890			01234567890	01234567890	01234567890	01234567890	01234567890	01234567890	01234567890	01234567890			1)	2000 to 25999	07D0 to 658F
Axis1										Axis3																																																																																																																																																																																																																																																																																																																																																																													
No.	Part	Int.	Cont.	Acc.	Dec.	Dwell	Mcode			No.	Part	Int.	Cont.	Acc.	Dec.	Dwell	Mcode																																																																																																																																																																																																																																																																																																																																																																						
		Address	Arc address	Instn. speed								Address	Arc address	Instn. speed																																																																																																																																																																																																																																																																																																																																																																									
	01	01	01	01	01	01	01234	01234			01	01	01	01	01	01	01234	01234																																																																																																																																																																																																																																																																																																																																																																					
	01234567890	01234567890	01234567890	01234567890	01234567890	01234567890	01234567890	01234567890			01234567890	01234567890	01234567890	01234567890	01234567890	01234567890	01234567890	01234567890																																																																																																																																																																																																																																																																																																																																																																					
	01	01	01	01	01	01	01234	01234			01	01	01	01	01	01	01234	01234																																																																																																																																																																																																																																																																																																																																																																					
	01234567890	01234567890	01234567890	01234567890	01234567890	01234567890	01234567890	01234567890			01234567890	01234567890	01234567890	01234567890	01234567890	01234567890	01234567890	01234567890																																																																																																																																																																																																																																																																																																																																																																					
	01	01	01	01	01	01	01234	01234			01	01	01	01	01	01	01234	01234																																																																																																																																																																																																																																																																																																																																																																					
	01234567890	01234567890	01234567890	01234567890	01234567890	01234567890	01234567890	01234567890			01234567890	01234567890	01234567890	01234567890	01234567890	01234567890	01234567890	01234567890																																																																																																																																																																																																																																																																																																																																																																					
Axis2										Axis4																																																																																																																																																																																																																																																																																																																																																																													
No.	Part	Int.	Cont.	Acc.	Dec.	Dwell	Mcode			No.	Part	Int.	Cont.	Acc.	Dec.	Dwell	Mcode																																																																																																																																																																																																																																																																																																																																																																						
		Address	Arc address	Instn. speed								Address	Arc address	Instn. speed																																																																																																																																																																																																																																																																																																																																																																									
	01	01	01	01	01	01	01234	01234			01	01	01	01	01	01	01234	01234																																																																																																																																																																																																																																																																																																																																																																					
	01234567890	01234567890	01234567890	01234567890	01234567890	01234567890	01234567890	01234567890			01234567890	01234567890	01234567890	01234567890	01234567890	01234567890	01234567890	01234567890																																																																																																																																																																																																																																																																																																																																																																					
	01	01	01	01	01	01	01234	01234			01	01	01	01	01	01	01234	01234																																																																																																																																																																																																																																																																																																																																																																					
	01234567890	01234567890	01234567890	01234567890	01234567890	01234567890	01234567890	01234567890			01234567890	01234567890	01234567890	01234567890	01234567890	01234567890	01234567890	01234567890																																																																																																																																																																																																																																																																																																																																																																					
	01	01	01	01	01	01	01234	01234			01	01	01	01	01	01	01234	01234																																																																																																																																																																																																																																																																																																																																																																					
	01234567890	01234567890	01234567890	01234567890	01234567890	01234567890	01234567890	01234567890			01234567890	01234567890	01234567890	01234567890	01234567890	01234567890	01234567890	01234567890																																																																																																																																																																																																																																																																																																																																																																					

12.32 QD75M Module Monitor

Screen Image	No.	Buffer memory address	
		dec.	hex.
<p>1) 2) 3) 4) 5) 6) 7) 8) 9) 10) 11) 12)</p>	1)	800 to 801	0320 to 0321
		900 to 901	0384 to 0385
		1000 to 1001	03E8 to 03E9
		1100 to 1101	044C to 044D
	2)	812 to 813	032C to 032D
		912 to 913	0390 to 0391
		1012 to 1013	03F4 to 03F5
		1112 to 1113	0458 to 0459
	3)	809, 909,	0329, 038D,
		1009, 1109	03F1, 0455
	4)	806, 906,	0326, 038A,
		1006, 1106	03EE, 0452
5)	807, 907,	0327, 038B,	
	1007, 1107	03EF, 0453	
6)	808, 908,	0328, 038C,	
	1008, 1108	03F0, 0454	
7)	829, 929,	033D, 03A1,	
	1029, 1129	0405, 0469	
8) to 12)	838, 938,	0346, 03AA,	
	1038, 1138	040E, 0472	
<p>1)</p>	1)	---	---
<p>1) 2) 3) 4)</p>	1)	0, 150, 300, 450	0000, 0096, 012C, 01C2
	2)	2 to 3, 152 to 153, 302 to 303, 452 to 453	0002 to 0003, 0098 to 0099, 012E to 012F, 01C4 to 01C7
	3)	1, 151, 301, 451	0001, 0097, 0012D, 01C3
	4)	4 to 5, 154 to 155, 304 to 305, 454 to 455	0004 to 0005, 009A to 009B, 0130 to 0131, 01C6 to 01C7

Screen Image		No.	Buffer memory address																																																																																																																		
			dec.	hex.																																																																																																																	
<p>QD75M Basic parameters 2</p> <table border="1"> <tr> <th colspan="4">Speed limit value</th> <th colspan="4">Deceleration time 0</th> </tr> <tr> <td>Axis1</td><td>0123456789</td> <td>Axis2</td><td>0123456789</td> <td>Axis1</td><td>01234567</td> <td>Axis2</td><td>01234567</td> </tr> <tr> <td>Axis3</td><td>0123456789</td> <td>Axis4</td><td>0123456789</td> <td>Axis3</td><td>01234567</td> <td>Axis4</td><td>01234567</td> </tr> <tr> <td>Setting range</td><td colspan="3">1 to 200000000 (mm/min):*10⁻³ (inch/min):*10⁻³ (degree/min):*10⁻³ 1 to 10000000(pulse/sec):*1</td> <td>Setting range</td><td colspan="3">1 to 8388608(msec)</td> </tr> </table> <table border="1"> <tr> <th colspan="4">Acceleration time 0</th> </tr> <tr> <td>Axis1</td><td>01234567</td> <td>Axis2</td><td>01234567</td> </tr> <tr> <td>Axis3</td><td>01234567</td> <td>Axis4</td><td>01234567</td> </tr> <tr> <td>Setting range</td><td colspan="3">1 to 8388608(msec)</td> </tr> </table>	Speed limit value				Deceleration time 0				Axis1	0123456789	Axis2	0123456789	Axis1	01234567	Axis2	01234567	Axis3	0123456789	Axis4	0123456789	Axis3	01234567	Axis4	01234567	Setting range	1 to 200000000 (mm/min):*10 ⁻³ (inch/min):*10 ⁻³ (degree/min):*10 ⁻³ 1 to 10000000(pulse/sec):*1			Setting range	1 to 8388608(msec)			Acceleration time 0				Axis1	01234567	Axis2	01234567	Axis3	01234567	Axis4	01234567	Setting range	1 to 8388608(msec)			1)	10 to 11	000A to 000B																																																																		
	Speed limit value				Deceleration time 0																																																																																																																
	Axis1	0123456789	Axis2	0123456789	Axis1	01234567	Axis2	01234567																																																																																																													
	Axis3	0123456789	Axis4	0123456789	Axis3	01234567	Axis4	01234567																																																																																																													
	Setting range	1 to 200000000 (mm/min):*10 ⁻³ (inch/min):*10 ⁻³ (degree/min):*10 ⁻³ 1 to 10000000(pulse/sec):*1			Setting range	1 to 8388608(msec)																																																																																																															
	Acceleration time 0																																																																																																																				
	Axis1	01234567	Axis2	01234567																																																																																																																	
	Axis3	01234567	Axis4	01234567																																																																																																																	
	Setting range	1 to 8388608(msec)																																																																																																																			
				160 to 161	00A0 to 00A1																																																																																																																
				310 to 311	0136 to 0137																																																																																																																
				460 to 461	01CC to 01CD																																																																																																																
		2)	12 to 13	000C to 000D																																																																																																																	
			162 to 163	00A2 to 00A3																																																																																																																	
			312 to 313	0138 to 0139																																																																																																																	
			462 to 463	01CE to 01CF																																																																																																																	
		3)	14 to 15	000E to 000F																																																																																																																	
			164 to 165	00A4 to 00A5																																																																																																																	
			314 to 315	013A to 013B																																																																																																																	
			464 to 465	01D0 to 01D1																																																																																																																	
		—	—	—																																																																																																																	
<p>QD75M Detailed parameters 1-1</p> <table border="1"> <tr> <th colspan="4">Backlash compensation amount</th> <th colspan="4">Manual pulse generator input selection</th> </tr> <tr> <td>Axis1</td><td>01234</td> <td>Axis2</td><td>01234</td> <td>Axis1</td><td>0</td> <td>Axis2</td><td>-</td> </tr> <tr> <td>Axis3</td><td>01234</td> <td>Axis4</td><td>01234</td> <td>Axis3</td><td>-</td> <td>Axis4</td><td>-</td> </tr> <tr> <td>Setting range</td><td colspan="3">0 to 65535 (μm):*10⁻¹ (inch):*10⁻⁴ (degree):*10⁻⁴ (pulse):*1</td> <td>Setting range</td><td colspan="3">----- 0:A-phase/B-phase;multiplied by 4 1:A-phase/B-phase;multiplied by 2 2:A-phase/B-phase;multiplied by 1 3:PLS/SIGN</td> </tr> </table> <table border="1"> <tr> <th colspan="4">Software stroke upper limit value</th> <th colspan="4">Item</th> </tr> <tr> <td>High Lmt</td><td>Axis 1</td><td>01234567890</td> <td>Axis 2</td><td>01234567890</td> <td>S/W stroke limit select</td><td>0</td><td>0</td><td>0</td><td>0</td> </tr> <tr> <td>Low Lmt</td><td>Axis 1</td><td>01234567890</td> <td>Axis 2</td><td>01234567890</td> <td>S/W stroke limit OK/NG setting</td><td>0</td><td>0</td><td>0</td><td>0</td> </tr> <tr> <td>Setting Range</td><td colspan="3">-2147483648 (μm):*10⁻¹(inch):*10⁻⁴ to 2147483647 (pulse):*1 0 to 35999999 (degree):*10⁻⁴</td> <td>Torque limit set value</td><td>012</td><td>012</td><td>012</td><td>012</td><td>1~500 [%]</td> </tr> </table>	Backlash compensation amount				Manual pulse generator input selection				Axis1	01234	Axis2	01234	Axis1	0	Axis2	-	Axis3	01234	Axis4	01234	Axis3	-	Axis4	-	Setting range	0 to 65535 (μm):*10 ⁻¹ (inch):*10 ⁻⁴ (degree):*10 ⁻⁴ (pulse):*1			Setting range	----- 0:A-phase/B-phase;multiplied by 4 1:A-phase/B-phase;multiplied by 2 2:A-phase/B-phase;multiplied by 1 3:PLS/SIGN			Software stroke upper limit value				Item				High Lmt	Axis 1	01234567890	Axis 2	01234567890	S/W stroke limit select	0	0	0	0	Low Lmt	Axis 1	01234567890	Axis 2	01234567890	S/W stroke limit OK/NG setting	0	0	0	0	Setting Range	-2147483648 (μm):*10 ⁻¹ (inch):*10 ⁻⁴ to 2147483647 (pulse):*1 0 to 35999999 (degree):*10 ⁻⁴			Torque limit set value	012	012	012	012	1~500 [%]	1)	17, 167, 317, 467	0011, 00A7, 013D, 01D3																																												
	Backlash compensation amount				Manual pulse generator input selection																																																																																																																
	Axis1	01234	Axis2	01234	Axis1	0	Axis2	-																																																																																																													
	Axis3	01234	Axis4	01234	Axis3	-	Axis4	-																																																																																																													
	Setting range	0 to 65535 (μm):*10 ⁻¹ (inch):*10 ⁻⁴ (degree):*10 ⁻⁴ (pulse):*1			Setting range	----- 0:A-phase/B-phase;multiplied by 4 1:A-phase/B-phase;multiplied by 2 2:A-phase/B-phase;multiplied by 1 3:PLS/SIGN																																																																																																															
	Software stroke upper limit value				Item																																																																																																																
	High Lmt	Axis 1	01234567890	Axis 2	01234567890	S/W stroke limit select	0	0	0	0																																																																																																											
	Low Lmt	Axis 1	01234567890	Axis 2	01234567890	S/W stroke limit OK/NG setting	0	0	0	0																																																																																																											
	Setting Range	-2147483648 (μm):*10 ⁻¹ (inch):*10 ⁻⁴ to 2147483647 (pulse):*1 0 to 35999999 (degree):*10 ⁻⁴			Torque limit set value	012	012	012	012	1~500 [%]																																																																																																											
				18 to 19	0012 to 0013																																																																																																																
				168 to 169	00A8 to 00A9																																																																																																																
				318 to 319	013E to 013F																																																																																																																
		2)	468 to 469	01D4 to 01D5																																																																																																																	
			20 to 21	0014 to 0015																																																																																																																	
			170 to 171	00AA to 00AB																																																																																																																	
			320 to 321	0140 to 0141																																																																																																																	
			470 to 471	01D6 to 01D7																																																																																																																	
		3)	33	0021																																																																																																																	
		4)	22, 172, 322, 472	0016, 00AC, 0142, 01D8																																																																																																																	
		5)	23, 173, 323, 473	0017, 00AD, 0143, 01D9																																																																																																																	
		6)	26, 176, 326, 476	001A, 00B0, 0146, 01DC																																																																																																																	
<p>QD75M Detailed parameters 1-2</p> <table border="1"> <tr> <th colspan="4">Item</th> <th colspan="4">Current feed val.during speed control</th> </tr> <tr> <td>Mcode ON sig O/P timing</td><td>0</td><td>0</td><td>0</td><td>0</td> <td>Axis 1</td><td>0</td> <td>Axis 2</td><td>0</td> <td>Axis 3</td><td>0</td> <td>Axis 4</td><td>0</td> </tr> <tr> <td>Speed switching mode</td><td>0</td><td>0</td><td>0</td><td>0</td> <td colspan="4">0:Do Not/1:Do/2: Clear(0)</td> </tr> <tr> <td>Interpolate speed set method</td><td>0</td><td>0</td><td>0</td><td>0</td> <th colspan="4">Speed-position function selection</th> </tr> <tr> <td></td><td>0</td><td>0</td><td>0</td><td>0</td> <td>Axis 1</td><td>0</td> <td>Axis 2</td><td>0</td> <td>Axis 3</td><td>0</td> <td>Axis 4</td><td>0</td> </tr> <tr> <td></td><td>0</td><td>0</td><td>0</td><td>0</td> <td colspan="4">0:Execute V/P switching control(INC) 2:Execute V/P switching control(ABS)</td> </tr> </table> <table border="1"> <tr> <th colspan="4">Command in-position width</th> <th colspan="4">Type dog selection</th> </tr> <tr> <td>Axis1</td><td>01234567890</td> <td>Axis2</td><td>01234567890</td> <td>Lower limit</td><td>Ne</td><td>Ne</td><td>Ne</td><td>Ne</td> </tr> <tr> <td>Axis3</td><td>01234567890</td> <td>Axis4</td><td>01234567890</td> <td>Upper limit</td><td>Ne</td><td>Ne</td><td>Ne</td><td>Ne</td> </tr> <tr> <td>Setting range</td><td colspan="3">1 to 2147483647 (μm):*10⁻¹(inch):*10⁻⁴ (degree):*10⁻⁴(pulse):*1</td> <td>Stop signal</td><td>Ne</td><td>Ne</td><td>Ne</td><td>Ne</td> </tr> <tr> <td></td><td></td><td></td><td></td> <td>External command</td><td>Ne</td><td>Ne</td><td>Ne</td><td>Ne</td> </tr> <tr> <td></td><td></td><td></td><td></td> <td>Near point dog</td><td>Ne</td><td>Ne</td><td>Ne</td><td>Ne</td> </tr> </table>	Item				Current feed val.during speed control				Mcode ON sig O/P timing	0	0	0	0	Axis 1	0	Axis 2	0	Axis 3	0	Axis 4	0	Speed switching mode	0	0	0	0	0:Do Not/1:Do/2: Clear(0)				Interpolate speed set method	0	0	0	0	Speed-position function selection					0	0	0	0	Axis 1	0	Axis 2	0	Axis 3	0	Axis 4	0		0	0	0	0	0:Execute V/P switching control(INC) 2:Execute V/P switching control(ABS)				Command in-position width				Type dog selection				Axis1	01234567890	Axis2	01234567890	Lower limit	Ne	Ne	Ne	Ne	Axis3	01234567890	Axis4	01234567890	Upper limit	Ne	Ne	Ne	Ne	Setting range	1 to 2147483647 (μm):*10 ⁻¹ (inch):*10 ⁻⁴ (degree):*10 ⁻⁴ (pulse):*1			Stop signal	Ne	Ne	Ne	Ne					External command	Ne	Ne	Ne	Ne					Near point dog	Ne	Ne	Ne	Ne	1)	27, 177, 327, 477	001B, 00B1, 0147, 01DD
	Item				Current feed val.during speed control																																																																																																																
	Mcode ON sig O/P timing	0	0	0	0	Axis 1	0	Axis 2	0	Axis 3	0	Axis 4	0																																																																																																								
	Speed switching mode	0	0	0	0	0:Do Not/1:Do/2: Clear(0)																																																																																																															
	Interpolate speed set method	0	0	0	0	Speed-position function selection																																																																																																															
		0	0	0	0	Axis 1	0	Axis 2	0	Axis 3	0	Axis 4	0																																																																																																								
		0	0	0	0	0:Execute V/P switching control(INC) 2:Execute V/P switching control(ABS)																																																																																																															
	Command in-position width				Type dog selection																																																																																																																
	Axis1	01234567890	Axis2	01234567890	Lower limit	Ne	Ne	Ne	Ne																																																																																																												
	Axis3	01234567890	Axis4	01234567890	Upper limit	Ne	Ne	Ne	Ne																																																																																																												
	Setting range	1 to 2147483647 (μm):*10 ⁻¹ (inch):*10 ⁻⁴ (degree):*10 ⁻⁴ (pulse):*1			Stop signal	Ne	Ne	Ne	Ne																																																																																																												
					External command	Ne	Ne	Ne	Ne																																																																																																												
				Near point dog	Ne	Ne	Ne	Ne																																																																																																													
		2)	28, 178, 328, 478	001C, 00B2, 0148, 01DE																																																																																																																	
		3)	29, 179, 329, 479	001D, 00B3, 0149, 01DF																																																																																																																	
		4)	24 to 25	0018 to 0019																																																																																																																	
			174 to 175	00AE to 00AF																																																																																																																	
			324 to 325	0144 to 0145																																																																																																																	
			474 to 475	01DA to 01DB																																																																																																																	
		5)	30, 180, 330, 480	001E, 00B4, 014A, 01E0																																																																																																																	
		6)	34, 184, 334, 484	0022, 00B8, 014E, 01E4																																																																																																																	
		7)	31, 181, 331, 481	001F, 00B5, 014B, 01E1																																																																																																																	

Screen Image		No.	Buffer memory address																																																																																																																																
			dec.	hex.																																																																																																																															
<p>QD75M Detailed parameters 2-1</p> <table border="1"> <tr> <th>Acc. time</th> <th>Axis1</th> <th>Axis2</th> <th>Axis3</th> <th>Axis4</th> </tr> <tr> <td>1</td> <td>0123456</td> <td>0123456</td> <td>0123456</td> <td>0123456</td> </tr> <tr> <td>2</td> <td>0123456</td> <td>0123456</td> <td>0123456</td> <td>0123456</td> </tr> <tr> <td>3</td> <td>0123456</td> <td>0123456</td> <td>0123456</td> <td>0123456</td> </tr> <tr> <td colspan="5">Setting range 1 to 8388608 (msec)</td> </tr> </table> <table border="1"> <tr> <th colspan="6">JOG speed limit value</th> </tr> <tr> <th>Axis1</th> <th>Axis2</th> <th>Axis3</th> <th>Axis4</th> <th>Setting range</th> <th></th> </tr> <tr> <td>0123456789</td> <td>0123456789</td> <td>0123456789</td> <td>0123456789</td> <td>1 to 2000000000 (mm/min):*10⁻³</td> <td></td> </tr> <tr> <td></td> <td></td> <td></td> <td></td> <td>(inch/min):*10⁻³</td> <td></td> </tr> <tr> <td></td> <td></td> <td></td> <td></td> <td>(degree/min):*10⁻³</td> <td></td> </tr> <tr> <td></td> <td></td> <td></td> <td></td> <td>1 to 10000000 (pulse/sec):*1</td> <td></td> </tr> </table> <table border="1"> <tr> <th>Dec. time</th> <th>Axis1</th> <th>Axis2</th> <th>Axis3</th> <th>Axis4</th> </tr> <tr> <td>1</td> <td>0123456</td> <td>0123456</td> <td>0123456</td> <td>0123456</td> </tr> <tr> <td>2</td> <td>0123456</td> <td>0123456</td> <td>0123456</td> <td>0123456</td> </tr> <tr> <td>3</td> <td>0123456</td> <td>0123456</td> <td>0123456</td> <td>0123456</td> </tr> <tr> <td colspan="5">Setting range 1 to 8388608 (msec)</td> </tr> </table> <table border="1"> <tr> <th>Item</th> <th>AX.1</th> <th>AX.2</th> <th>AX.3</th> <th>AX.4</th> <th>Set. range</th> </tr> <tr> <td>JOG accel. time select</td> <td>0</td> <td>0</td> <td>0</td> <td>0</td> <td>0 to 3</td> </tr> <tr> <td>JOG decel. time select</td> <td>0</td> <td>0</td> <td>0</td> <td>0</td> <td>0 to 3</td> </tr> </table>	Acc. time	Axis1	Axis2	Axis3	Axis4	1	0123456	0123456	0123456	0123456	2	0123456	0123456	0123456	0123456	3	0123456	0123456	0123456	0123456	Setting range 1 to 8388608 (msec)					JOG speed limit value						Axis1	Axis2	Axis3	Axis4	Setting range		0123456789	0123456789	0123456789	0123456789	1 to 2000000000 (mm/min):*10 ⁻³						(inch/min):*10 ⁻³						(degree/min):*10 ⁻³						1 to 10000000 (pulse/sec):*1		Dec. time	Axis1	Axis2	Axis3	Axis4	1	0123456	0123456	0123456	0123456	2	0123456	0123456	0123456	0123456	3	0123456	0123456	0123456	0123456	Setting range 1 to 8388608 (msec)					Item	AX.1	AX.2	AX.3	AX.4	Set. range	JOG accel. time select	0	0	0	0	0 to 3	JOG decel. time select	0	0	0	0	0 to 3	1)	36 to 41	0024 to 0029																								
	Acc. time	Axis1	Axis2	Axis3	Axis4																																																																																																																														
	1	0123456	0123456	0123456	0123456																																																																																																																														
	2	0123456	0123456	0123456	0123456																																																																																																																														
	3	0123456	0123456	0123456	0123456																																																																																																																														
	Setting range 1 to 8388608 (msec)																																																																																																																																		
	JOG speed limit value																																																																																																																																		
	Axis1	Axis2	Axis3	Axis4	Setting range																																																																																																																														
	0123456789	0123456789	0123456789	0123456789	1 to 2000000000 (mm/min):*10 ⁻³																																																																																																																														
					(inch/min):*10 ⁻³																																																																																																																														
				(degree/min):*10 ⁻³																																																																																																																															
				1 to 10000000 (pulse/sec):*1																																																																																																																															
Dec. time	Axis1	Axis2	Axis3	Axis4																																																																																																																															
1	0123456	0123456	0123456	0123456																																																																																																																															
2	0123456	0123456	0123456	0123456																																																																																																																															
3	0123456	0123456	0123456	0123456																																																																																																																															
Setting range 1 to 8388608 (msec)																																																																																																																																			
Item	AX.1	AX.2	AX.3	AX.4	Set. range																																																																																																																														
JOG accel. time select	0	0	0	0	0 to 3																																																																																																																														
JOG decel. time select	0	0	0	0	0 to 3																																																																																																																														
	1)	186 to 191	00BA to 00BF																																																																																																																																
	1)	336 to 341	0150 to 0155																																																																																																																																
	1)	486 to 491	01E6 to 01EB																																																																																																																																
	2)	42 to 47	002A to 002F																																																																																																																																
	2)	192 to 197	00C0 to 00C5																																																																																																																																
	2)	342 to 347	0156 to 015B																																																																																																																																
	2)	492 to 496	01EC to 01F0																																																																																																																																
	3)	48 to 49	0030 to 0031																																																																																																																																
	3)	198 to 199	00C6 to 00C7																																																																																																																																
	3)	348 to 349	015C to 015D																																																																																																																																
	3)	498 to 499	01F2 to 01F3																																																																																																																																
	4)	50, 200, 350, 500	0032, 00C8, 015E, 01F4																																																																																																																																
	5)	51, 501, 351, 501	0033, 01F5, 015F, 01F5																																																																																																																																
<p>QD75M Detailed parameters 2-2</p> <table border="1"> <tr> <th>Item</th> <th>AX.1</th> <th>AX.2</th> <th>AX.3</th> <th>AX.4</th> <th>Set. range</th> </tr> <tr> <td>Acc/Dec Type selection</td> <td>0</td> <td>0</td> <td>0</td> <td>0</td> <td>0:Ramp 1:Curve</td> </tr> <tr> <td>S-pattern %</td> <td>012</td> <td>012</td> <td>012</td> <td>012</td> <td>1-100(%)</td> </tr> <tr> <td>Sudden stop decd. time</td> <td>1</td> <td>0</td> <td>0</td> <td>0</td> <td>0:Normal 1:Sudden stop</td> </tr> <tr> <td>Sudden stop decd. time</td> <td>2</td> <td>0</td> <td>0</td> <td>0</td> <td></td> </tr> <tr> <td>Sudden stop decd. time</td> <td>3</td> <td>0</td> <td>0</td> <td>0</td> <td></td> </tr> <tr> <td>Sudden stop deceleration time</td> <td>Axis1</td> <td>Axis2</td> <td>Axis3</td> <td>Axis4</td> <td></td> </tr> <tr> <td></td> <td>0123456</td> <td>0123456</td> <td>0123456</td> <td>0123456</td> <td>1 to 8388608 (ms)</td> </tr> <tr> <td>Position complete signal output time</td> <td>Axis1</td> <td>Axis2</td> <td>Axis3</td> <td>Axis4</td> <td></td> </tr> <tr> <td></td> <td>01234</td> <td>01234</td> <td>01234</td> <td>01234</td> <td>0 to 65535 (ms)</td> </tr> </table> <table border="1"> <tr> <th colspan="5">Allowed circular int. error width</th> </tr> <tr> <th>Axis1</th> <th>Axis2</th> <th>Axis3</th> <th>Axis4</th> <th>Setting range</th> </tr> <tr> <td>012345</td> <td>012345</td> <td>012345</td> <td>012345</td> <td>0 to 100000</td> </tr> <tr> <td></td> <td></td> <td></td> <td></td> <td>(μm):*10⁻¹</td> </tr> <tr> <td></td> <td></td> <td></td> <td></td> <td>(inch):*10⁻³</td> </tr> <tr> <td></td> <td></td> <td></td> <td></td> <td>(degree):*10⁻³</td> </tr> <tr> <td></td> <td></td> <td></td> <td></td> <td>(pulse):*1</td> </tr> </table> <table border="1"> <tr> <th colspan="6">External command function selection</th> </tr> <tr> <th>AX.1</th> <th>AX.2</th> <th>AX.3</th> <th>AX.4</th> <th>0</th> <th>0</th> </tr> <tr> <td>0</td> <td>0</td> <td>0</td> <td>0</td> <td>0</td> <td>0</td> </tr> </table> <table border="1"> <tr> <th colspan="5">Restart allowable range (servo OFF->ON)</th> </tr> <tr> <th>Axis1</th> <th>Axis2</th> <th>Axis3</th> <th>Axis4</th> <th>Setting range</th> </tr> <tr> <td>0123456</td> <td>0123456</td> <td>0123456</td> <td>0123456</td> <td>0, 1 to 163840 [PLS] 0:Can't Restart</td> </tr> </table>	Item	AX.1	AX.2	AX.3	AX.4	Set. range	Acc/Dec Type selection	0	0	0	0	0:Ramp 1:Curve	S-pattern %	012	012	012	012	1-100(%)	Sudden stop decd. time	1	0	0	0	0:Normal 1:Sudden stop	Sudden stop decd. time	2	0	0	0		Sudden stop decd. time	3	0	0	0		Sudden stop deceleration time	Axis1	Axis2	Axis3	Axis4			0123456	0123456	0123456	0123456	1 to 8388608 (ms)	Position complete signal output time	Axis1	Axis2	Axis3	Axis4			01234	01234	01234	01234	0 to 65535 (ms)	Allowed circular int. error width					Axis1	Axis2	Axis3	Axis4	Setting range	012345	012345	012345	012345	0 to 100000					(μm):*10 ⁻¹					(inch):*10 ⁻³					(degree):*10 ⁻³					(pulse):*1	External command function selection						AX.1	AX.2	AX.3	AX.4	0	0	0	0	0	0	0	0	Restart allowable range (servo OFF->ON)					Axis1	Axis2	Axis3	Axis4	Setting range	0123456	0123456	0123456	0123456	0, 1 to 163840 [PLS] 0:Can't Restart	1)	52, 202, 352, 502	0034, 00CA, 0160, 01F6
	Item	AX.1	AX.2	AX.3	AX.4	Set. range																																																																																																																													
	Acc/Dec Type selection	0	0	0	0	0:Ramp 1:Curve																																																																																																																													
	S-pattern %	012	012	012	012	1-100(%)																																																																																																																													
	Sudden stop decd. time	1	0	0	0	0:Normal 1:Sudden stop																																																																																																																													
	Sudden stop decd. time	2	0	0	0																																																																																																																														
	Sudden stop decd. time	3	0	0	0																																																																																																																														
	Sudden stop deceleration time	Axis1	Axis2	Axis3	Axis4																																																																																																																														
		0123456	0123456	0123456	0123456	1 to 8388608 (ms)																																																																																																																													
	Position complete signal output time	Axis1	Axis2	Axis3	Axis4																																																																																																																														
	01234	01234	01234	01234	0 to 65535 (ms)																																																																																																																														
Allowed circular int. error width																																																																																																																																			
Axis1	Axis2	Axis3	Axis4	Setting range																																																																																																																															
012345	012345	012345	012345	0 to 100000																																																																																																																															
				(μm):*10 ⁻¹																																																																																																																															
				(inch):*10 ⁻³																																																																																																																															
				(degree):*10 ⁻³																																																																																																																															
				(pulse):*1																																																																																																																															
External command function selection																																																																																																																																			
AX.1	AX.2	AX.3	AX.4	0	0																																																																																																																														
0	0	0	0	0	0																																																																																																																														
Restart allowable range (servo OFF->ON)																																																																																																																																			
Axis1	Axis2	Axis3	Axis4	Setting range																																																																																																																															
0123456	0123456	0123456	0123456	0, 1 to 163840 [PLS] 0:Can't Restart																																																																																																																															
	2)	53, 203, 353, 503	0035, 00CB, 0161, 01F7																																																																																																																																
	3)	56, 206, 356, 506	0038, 00CE, 0164, 01FA																																																																																																																																
	4)	57, 207, 357, 507	0039, 00CF, 0165, 01FB																																																																																																																																
	5)	58, 208, 358, 508	003A, 00D0, 0166, 01FC																																																																																																																																
	6)	54 to 55, 204 to 205, 354 to 355, 504 to 505	0036 to 0037, 00CC to 00CD, 0162 to 0163, 01F8 to 01F9																																																																																																																																
	7)	59, 209, 359, 509	003B, 00D1, 0167, 01FD																																																																																																																																
	8)	60 to 61, 210 to 211, 360 to 361, 510 to 511	003C to 003D, 00D2 to 00D3, 0168 to 0169, 01FE to 01FF																																																																																																																																
	9)	62, 212, 362, 512	003E, 00D4, 016A, 0200																																																																																																																																
	10)	64 to 65, 214 to 215, 364 to 365, 514 to 515	0040 to 0041, 00D6 to 00D7, 016C to 016D, 0202 to 0203																																																																																																																																

Screen Image		No.	Buffer memory address	
			dec.	hex.
		1)	79, 229, 379, 529	004F, 00E5, 017B, 0211
		2)	82, 232, 382, 532	0052, 00E8, 017E, 0214
		3)	83, 233, 383, 533	0053, 00E9, 017F, 0215
		4)	86, 236, 386, 536	0056, 00EC, 0182, 0218
		5)	80 to 81	0050 to 0051
			230 to 231	00E6 to 00E7
			380 to 381	017C to 017D
		6)	530 to 531	0212 to 0213
			84 to 85	0054 to 0055
			234 to 235	00EA to 00EB
		7)	384 to 385	0180 to 0181
			534 to 535	0216 to 0217
		7)	88, 238, 388, 538	0058, 00EE, 0184, 021A
		8)	89, 239, 389, 539	0059, 00EF, 0185, 021B
		1)	70, 220, 370, 520	0046, 00DC, 0172, 0208
		2)	71, 221, 371, 521	0047, 00DD, 0173, 0209
		3)	78, 228, 378, 528	004E, 00E4, 017A, 0210
		4)	72 to 73	0048 to 0049
			222 to 223	00DE to 00DF
		5)	372 to 373	0174 to 0175
			522 to 523	020A to 020B
			74 to 75	004A to 004B
		6)	224 to 225	00E0 to 00E1
			374 to 375	0176 to 0177
			524 to 525	020C to 020D
		6)	76 to 77	004C to 004D
			226 to 227	00E2 to 00E3
			376 to 377	0178 to 0179
526 to 527	020E to 020F			

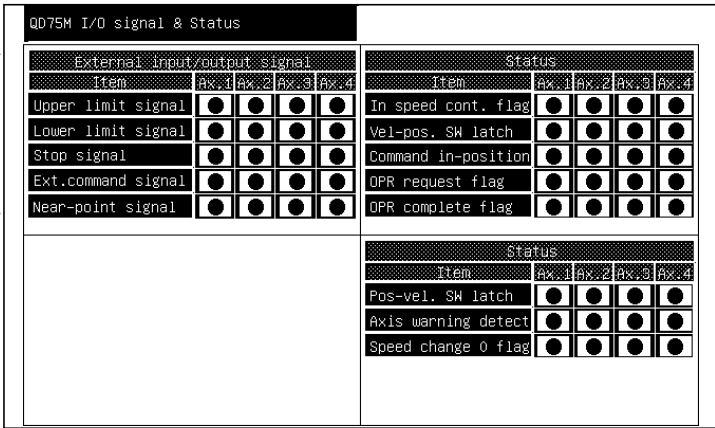
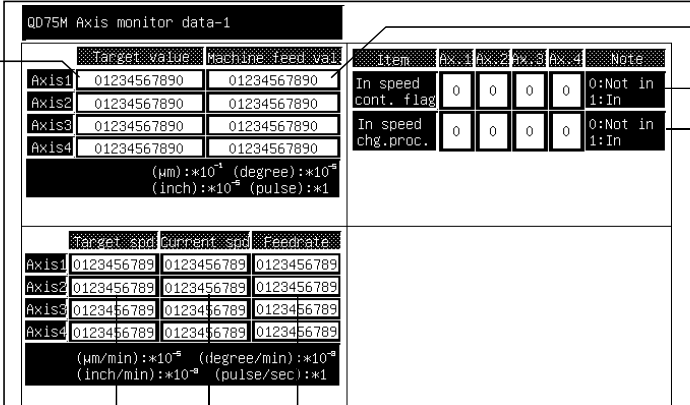
Screen Image	No.	Buffer memory address		
		dec.	hex.	
	1)	816, 916, 1016, 1116	0330, 0394, 03F8, 045C	
	2)	817, 917, 1017, 1117	0331, 0395, 03F9, 045D	
	1)	818 to 819	0332 to 0333	
	6)	918 to 919	0396 to 0397	
		1018 to 1019	03FA to 03FB	
		1118 to 1119	045E to 045F	
	7)	802 to 803	0322 to 0323	
		902 to 903	0386 to 0387	
		1002 to 1003	03EA to 03EB	
	2)	1102 to 1103	044E to 044F	
		3)	820 to 821	0334 to 0335
			920 to 921	0398 to 0399
	1020 to 1021		03FC to 03FD	
	4)	1120 to 1121	0460 to 0461	
		810 to 811	032A to 032B	
		910 to 911	038E to 038F	
	5)	1010 to 1011	03F2 to 03F3	
		1110 to 1111	0456 to 0457	
		812 to 813	032C to 032D	
	6)	912 to 913	0390 to 0391	
		1012 to 1013	03F4 to 03F5	
		1112 to 1113	0458 to 0459	
7)	830, 930,1030, 1130	033E, 03A2, 0406, 046A		
	831, 931, 1031, 1131	033F, 03A3, 0407, 046B		

Screen Image	No.	Buffer memory address																																																																																												
		dec.	hex.																																																																																											
<p>QD75M Axis monitor data-2</p> <table border="1"> <thead> <tr> <th colspan="4">Special start data</th> <th colspan="4">Special start repetition counter</th> </tr> <tr> <th>Axis</th> <th>Instr. code</th> <th>Instr. pake</th> <th>Data No.</th> <th>Axis1</th> <th>Axis2</th> <th>Axis3</th> <th>Axis4</th> </tr> </thead> <tbody> <tr> <td>1</td> <td>01</td> <td>012</td> <td>0123</td> <td>012</td> <td>012</td> <td>012</td> <td>012</td> </tr> <tr> <td>2</td> <td>01</td> <td>012</td> <td>0123</td> <td></td> <td></td> <td></td> <td></td> </tr> <tr> <td>3</td> <td>01</td> <td>012</td> <td>0123</td> <td></td> <td></td> <td></td> <td></td> </tr> <tr> <td>4</td> <td>01</td> <td>012</td> <td>0123</td> <td></td> <td></td> <td></td> <td></td> </tr> </tbody> </table> <table border="1"> <thead> <tr> <th colspan="4">Data being executed</th> <th>Previous position</th> </tr> <tr> <th>Axis</th> <th>Inst. data pointer</th> <th>Pos. data Number</th> <th>Block No.</th> <th></th> </tr> </thead> <tbody> <tr> <td>1</td> <td>012</td> <td>0123</td> <td>012</td> <td>0123</td> </tr> <tr> <td>2</td> <td>012</td> <td>0123</td> <td>012</td> <td>0123</td> </tr> <tr> <td>3</td> <td>012</td> <td>0123</td> <td>012</td> <td>0123</td> </tr> <tr> <td>4</td> <td>012</td> <td>0123</td> <td>012</td> <td>0123</td> </tr> </tbody> </table> <p>1) 4) 5) 2) 6) 7) 3)</p>	Special start data				Special start repetition counter				Axis	Instr. code	Instr. pake	Data No.	Axis1	Axis2	Axis3	Axis4	1	01	012	0123	012	012	012	012	2	01	012	0123					3	01	012	0123					4	01	012	0123					Data being executed				Previous position	Axis	Inst. data pointer	Pos. data Number	Block No.		1	012	0123	012	0123	2	012	0123	012	0123	3	012	0123	012	0123	4	012	0123	012	0123	1)	827, 927, 1027, 1127	033B, 039F, 0403, 0467													
	Special start data				Special start repetition counter																																																																																									
	Axis	Instr. code	Instr. pake	Data No.	Axis1	Axis2	Axis3	Axis4																																																																																						
	1	01	012	0123	012	012	012	012																																																																																						
	2	01	012	0123																																																																																										
	3	01	012	0123																																																																																										
	4	01	012	0123																																																																																										
	Data being executed				Previous position																																																																																									
	Axis	Inst. data pointer	Pos. data Number	Block No.																																																																																										
1	012	0123	012	0123																																																																																										
2	012	0123	012	0123																																																																																										
3	012	0123	012	0123																																																																																										
4	012	0123	012	0123																																																																																										
	2)	828, 928, 1028, 1128	033C, 03A0, 0404, 0468																																																																																											
	3)	829, 929, 1029, 1129	033D, 03A1, 0405, 0469																																																																																											
	4)	834, 934, 1034, 1134	0342, 03A6, 040A, 046E																																																																																											
	5)	835, 936, 1036, 1135	0343, 03A8, 040C, 046F																																																																																											
	6)	836, 936, 1036, 1136	0344, 03A8, 040C, 0470																																																																																											
	7)	837, 937, 1037, 1137	0345, 03A9, 040D, 0471																																																																																											
	8)	832, 932, 1032, 1132	0340, 03A4, 0408, 046C																																																																																											
	9)	833, 933, 1033, 1133	0341, 03A5, 0409, 046D																																																																																											
	—	—	—																																																																																											
<p>QD75M Axis monitor data-3</p> <table border="1"> <thead> <tr> <th>Axis</th> <th>OPR increment</th> <th>Actual present val.</th> <th>Error counter val.</th> <th colspan="7">Servo parameter</th> </tr> <tr> <th></th> <th></th> <th></th> <th></th> <th>Axis (1)</th> <th>(2)</th> <th>(3)</th> <th>(4)</th> <th>(5)</th> <th>(6)</th> <th>(7)</th> </tr> </thead> <tbody> <tr> <td>1</td> <td>0123456789</td> <td>0123456789</td> <td>0123456789</td> <td>01234</td> <td>01234</td> <td>01234</td> <td>01234</td> <td>01234</td> <td>01234</td> <td>01234</td> </tr> <tr> <td>2</td> <td>0123456789</td> <td>0123456789</td> <td>0123456789</td> <td>01234</td> <td>01234</td> <td>01234</td> <td>01234</td> <td>01234</td> <td>01234</td> <td>01234</td> </tr> <tr> <td>3</td> <td>0123456789</td> <td>0123456789</td> <td>0123456789</td> <td>01234</td> <td>01234</td> <td>01234</td> <td>01234</td> <td>01234</td> <td>01234</td> <td>01234</td> </tr> <tr> <td>4</td> <td>0123456789</td> <td>0123456789</td> <td>0123456789</td> <td>01234</td> <td>01234</td> <td>01234</td> <td>01234</td> <td>01234</td> <td>01234</td> <td>01234</td> </tr> </tbody> </table> <table border="1"> <thead> <tr> <th>Axis</th> <th>Number of motor rotation</th> <th>motor current</th> <th>Axis</th> <th>Servo amplifier S/W number</th> </tr> </thead> <tbody> <tr> <td>1</td> <td>0123456789</td> <td>01234</td> <td>1</td> <td>01 01 01 01 01 01 01 01 01 01</td> </tr> <tr> <td>2</td> <td>0123456789</td> <td>01234</td> <td>2</td> <td>01 01 01 01 01 01 01 01 01 01</td> </tr> <tr> <td>3</td> <td>0123456789</td> <td>01234</td> <td>3</td> <td>01 01 01 01 01 01 01 01 01 01</td> </tr> <tr> <td>4</td> <td>0123456789</td> <td>01234</td> <td>4</td> <td>01 01 01 01 01 01 01 01 01 01</td> </tr> </tbody> </table> <p>1) 4) 2) 5) 3)</p>	Axis	OPR increment	Actual present val.	Error counter val.	Servo parameter											Axis (1)	(2)	(3)	(4)	(5)	(6)	(7)	1	0123456789	0123456789	0123456789	01234	01234	01234	01234	01234	01234	01234	2	0123456789	0123456789	0123456789	01234	01234	01234	01234	01234	01234	01234	3	0123456789	0123456789	0123456789	01234	01234	01234	01234	01234	01234	01234	4	0123456789	0123456789	0123456789	01234	01234	01234	01234	01234	01234	01234	Axis	Number of motor rotation	motor current	Axis	Servo amplifier S/W number	1	0123456789	01234	1	01 01 01 01 01 01 01 01 01 01	2	0123456789	01234	2	01 01 01 01 01 01 01 01 01 01	3	0123456789	01234	3	01 01 01 01 01 01 01 01 01 01	4	0123456789	01234	4	01 01 01 01 01 01 01 01 01 01	1)	848 to 849, 948 to 949, 1048 to 1049, 1148 to 1149	0350 to 0351, 03B4 to 03B5, 0418 to 0419, 047C to 047D
	Axis	OPR increment	Actual present val.	Error counter val.	Servo parameter																																																																																									
					Axis (1)	(2)	(3)	(4)	(5)	(6)	(7)																																																																																			
	1	0123456789	0123456789	0123456789	01234	01234	01234	01234	01234	01234	01234																																																																																			
	2	0123456789	0123456789	0123456789	01234	01234	01234	01234	01234	01234	01234																																																																																			
	3	0123456789	0123456789	0123456789	01234	01234	01234	01234	01234	01234	01234																																																																																			
	4	0123456789	0123456789	0123456789	01234	01234	01234	01234	01234	01234	01234																																																																																			
	Axis	Number of motor rotation	motor current	Axis	Servo amplifier S/W number																																																																																									
	1	0123456789	01234	1	01 01 01 01 01 01 01 01 01 01																																																																																									
	2	0123456789	01234	2	01 01 01 01 01 01 01 01 01 01																																																																																									
	3	0123456789	01234	3	01 01 01 01 01 01 01 01 01 01																																																																																									
	4	0123456789	01234	4	01 01 01 01 01 01 01 01 01 01																																																																																									
		2)	850 to 851, 950 to 951, 1050 to 1051, 1150 to 1151	0352 to 0353, 03B6 to 03B7, 041A to 041B, 047E to 047F																																																																																										
		3)	852 to 853, 952 to 953, 1052 to 1053, 1152 to 1153	0354 to 0355, 03B8 to 03B9, 041C to 041D, 0480 to 0481																																																																																										
		4)	854 to 855, 954 to 955, 1054 to 1055, 1154 to 1155	0356 to 0357, 03BA to 03BB, 041E to 041F, 0482 to 0483																																																																																										
		5)	856, 956, 1056, 1156	0358, 03BC, 0420, 0484																																																																																										
		6)	857, 957, 1057, 1157	0359, 03BD, 0421, 0485																																																																																										
			858, 958, 1058, 1158	035A, 03BE, 0422, 0486																																																																																										
			859, 959, 1059, 1159	035B, 03BF, 0423, 0487																																																																																										
			860, 960, 1060, 1160	035C, 03C0, 0424, 0488																																																																																										
			861, 961, 1061, 1161	035D, 03C1, 0425, 0489																																																																																										
	7)	862, 962, 1062, 1162	035E, 03C2, 0426, 048A																																																																																											
		863, 963, 1063, 1163	035F, 03C2, 0427, 048B																																																																																											
		864 to 869, 964 to 969, 1064 to 1069, 1164 to 1169	0360 to 0365, 03C4 to 03C9, 0428 to 042D, 048C to 0491																																																																																											

Screen Image	No.	Buffer memory address																																																																																																														
		dec.	hex.																																																																																																													
<p>QD75M Axis monitor data-4</p> <p>Parameter error No. (BIT 0:OK 1:ERROR)</p> <table border="1"> <tr> <th>Axis1</th> <th>Axis2</th> </tr> <tr> <td>0110110110110110</td> <td>0110110110110110</td> </tr> <tr> <td>No. 31 ← 15</td> <td>No. 31 ← 15</td> </tr> <tr> <td>0110110110110110</td> <td>0110110110110110</td> </tr> <tr> <td>No. 47 ← 32</td> <td>No. 47 ← 32</td> </tr> <tr> <td>0110110110110110</td> <td>0110110110110110</td> </tr> <tr> <td>No. 63 ← 48</td> <td>No. 63 ← 48</td> </tr> <tr> <td>0110110110110110</td> <td>0110110110110110</td> </tr> <tr> <td>No. 79 ← 64</td> <td>No. 79 ← 64</td> </tr> <tr> <td>0110110110110110</td> <td>0110110110110110</td> </tr> <tr> <td>No. 95 ← 80</td> <td>No. 95 ← 80</td> </tr> </table> <p>[Servo status]</p> <table border="1"> <tr> <th>Item</th> <th>Axis1</th> <th>Axis2</th> <th>Axis3</th> <th>Axis4</th> </tr> <tr> <td>Ready ON</td> <td>●</td> <td>●</td> <td>●</td> <td>●</td> </tr> <tr> <td>Servo ON</td> <td>●</td> <td>●</td> <td>●</td> <td>●</td> </tr> <tr> <td>Zero point passed</td> <td>●</td> <td>●</td> <td>●</td> <td>●</td> </tr> <tr> <td>In-position</td> <td>●</td> <td>●</td> <td>●</td> <td>●</td> </tr> <tr> <td>Zero speed</td> <td>●</td> <td>●</td> <td>●</td> <td>●</td> </tr> <tr> <td>Torque limit</td> <td>●</td> <td>●</td> <td>●</td> <td>●</td> </tr> <tr> <td>Servo alarm</td> <td>●</td> <td>●</td> <td>●</td> <td>●</td> </tr> <tr> <td>Servo warning</td> <td>●</td> <td>●</td> <td>●</td> <td>●</td> </tr> </table> <p>Parameter error No. (BIT 0:OK 1:ERROR)</p> <table border="1"> <tr> <th>Axis1</th> <th>Axis2</th> </tr> <tr> <td>0110110110110110</td> <td>0110110110110110</td> </tr> <tr> <td>No. 31 ← 15</td> <td>No. 31 ← 15</td> </tr> <tr> <td>0110110110110110</td> <td>0110110110110110</td> </tr> <tr> <td>No. 47 ← 32</td> <td>No. 47 ← 32</td> </tr> <tr> <td>0110110110110110</td> <td>0110110110110110</td> </tr> <tr> <td>No. 63 ← 48</td> <td>No. 63 ← 48</td> </tr> <tr> <td>0110110110110110</td> <td>0110110110110110</td> </tr> <tr> <td>No. 79 ← 64</td> <td>No. 79 ← 64</td> </tr> <tr> <td>0110110110110110</td> <td>0110110110110110</td> </tr> <tr> <td>No. 95 ← 80</td> <td>No. 95 ← 80</td> </tr> </table> <p>[Servo status]</p> <table border="1"> <tr> <th>Item</th> <th>Axis1</th> <th>Axis2</th> <th>Axis3</th> <th>Axis4</th> </tr> <tr> <td>Regenerative load ratio</td> <td>012</td> <td>012</td> <td>012</td> <td>012</td> </tr> <tr> <td>Actual load ratio</td> <td>012</td> <td>012</td> <td>012</td> <td>012</td> </tr> <tr> <td>Peak load ratio</td> <td>012</td> <td>012</td> <td>012</td> <td>012</td> </tr> </table>	Axis1	Axis2	0110110110110110	0110110110110110	No. 31 ← 15	No. 31 ← 15	0110110110110110	0110110110110110	No. 47 ← 32	No. 47 ← 32	0110110110110110	0110110110110110	No. 63 ← 48	No. 63 ← 48	0110110110110110	0110110110110110	No. 79 ← 64	No. 79 ← 64	0110110110110110	0110110110110110	No. 95 ← 80	No. 95 ← 80	Item	Axis1	Axis2	Axis3	Axis4	Ready ON	●	●	●	●	Servo ON	●	●	●	●	Zero point passed	●	●	●	●	In-position	●	●	●	●	Zero speed	●	●	●	●	Torque limit	●	●	●	●	Servo alarm	●	●	●	●	Servo warning	●	●	●	●	Axis1	Axis2	0110110110110110	0110110110110110	No. 31 ← 15	No. 31 ← 15	0110110110110110	0110110110110110	No. 47 ← 32	No. 47 ← 32	0110110110110110	0110110110110110	No. 63 ← 48	No. 63 ← 48	0110110110110110	0110110110110110	No. 79 ← 64	No. 79 ← 64	0110110110110110	0110110110110110	No. 95 ← 80	No. 95 ← 80	Item	Axis1	Axis2	Axis3	Axis4	Regenerative load ratio	012	012	012	012	Actual load ratio	012	012	012	012	Peak load ratio	012	012	012	012	1)	870, 970, 1070, 1170	0366, 03CA, 042E, 0492
	Axis1	Axis2																																																																																																														
	0110110110110110	0110110110110110																																																																																																														
	No. 31 ← 15	No. 31 ← 15																																																																																																														
	0110110110110110	0110110110110110																																																																																																														
	No. 47 ← 32	No. 47 ← 32																																																																																																														
	0110110110110110	0110110110110110																																																																																																														
	No. 63 ← 48	No. 63 ← 48																																																																																																														
	0110110110110110	0110110110110110																																																																																																														
	No. 79 ← 64	No. 79 ← 64																																																																																																														
	0110110110110110	0110110110110110																																																																																																														
	No. 95 ← 80	No. 95 ← 80																																																																																																														
	Item	Axis1	Axis2	Axis3	Axis4																																																																																																											
	Ready ON	●	●	●	●																																																																																																											
	Servo ON	●	●	●	●																																																																																																											
Zero point passed	●	●	●	●																																																																																																												
In-position	●	●	●	●																																																																																																												
Zero speed	●	●	●	●																																																																																																												
Torque limit	●	●	●	●																																																																																																												
Servo alarm	●	●	●	●																																																																																																												
Servo warning	●	●	●	●																																																																																																												
Axis1	Axis2																																																																																																															
0110110110110110	0110110110110110																																																																																																															
No. 31 ← 15	No. 31 ← 15																																																																																																															
0110110110110110	0110110110110110																																																																																																															
No. 47 ← 32	No. 47 ← 32																																																																																																															
0110110110110110	0110110110110110																																																																																																															
No. 63 ← 48	No. 63 ← 48																																																																																																															
0110110110110110	0110110110110110																																																																																																															
No. 79 ← 64	No. 79 ← 64																																																																																																															
0110110110110110	0110110110110110																																																																																																															
No. 95 ← 80	No. 95 ← 80																																																																																																															
Item	Axis1	Axis2	Axis3	Axis4																																																																																																												
Regenerative load ratio	012	012	012	012																																																																																																												
Actual load ratio	012	012	012	012																																																																																																												
Peak load ratio	012	012	012	012																																																																																																												
		871, 971, 1071, 1171	0367, 03CB, 042F, 0493																																																																																																													
		872, 972, 1072, 1172	0368, 03CC, 0430, 0494																																																																																																													
		873, 973, 1073, 1173	0369, 03CD, 0431, 0495																																																																																																													
		874, 974, 1074, 1174	036A, 03CE, 0432, 0496																																																																																																													
	2)	877, 977, 1077, 1177	036D, 03D1, 0435, 0499																																																																																																													
	3)	878, 978, 1078, 1178	036E, 03D2, 0436, 049A																																																																																																													
	4)	879, 979, 1079, 1179	036F, 03D3, 0437, 049B																																																																																																													
	5)	880, 980, 1080, 1180	0370, 03D4, 0438, 049C																																																																																																													
<p>QD75M OPR</p> <p>Axis traveled after NPO ON</p> <table border="1"> <tr> <th>Axis</th> <th>Travel</th> </tr> <tr> <td>1</td> <td>01234567890</td> </tr> <tr> <td>2</td> <td>01234567890</td> </tr> <tr> <td>3</td> <td>01234567890</td> </tr> <tr> <td>4</td> <td>01234567890</td> </tr> </table> <p>(μm:*10⁴) (inch:*10³) (degree:*10³) (pulse:*1)</p> <table border="1"> <tr> <th>Axis</th> <th>Torque limit stored value</th> <th>Near point</th> <th>Upper limit</th> <th>Lower limit</th> </tr> <tr> <td>1</td> <td>012 (%)</td> <td>●</td> <td>●</td> <td>●</td> </tr> <tr> <td>2</td> <td>012 (%)</td> <td>●</td> <td>●</td> <td>●</td> </tr> <tr> <td>3</td> <td>012 (%)</td> <td>●</td> <td>●</td> <td>●</td> </tr> <tr> <td>4</td> <td>012 (%)</td> <td>●</td> <td>●</td> <td>●</td> </tr> </table>	Axis	Travel	1	01234567890	2	01234567890	3	01234567890	4	01234567890	Axis	Torque limit stored value	Near point	Upper limit	Lower limit	1	012 (%)	●	●	●	2	012 (%)	●	●	●	3	012 (%)	●	●	●	4	012 (%)	●	●	●	1)	824 to 825 924 to 925 1024 to 1025 1124 to 1125	0338 to 0339 039C to 039D 0400 to 0401 0464 to 0465																																																																										
	Axis	Travel																																																																																																														
	1	01234567890																																																																																																														
	2	01234567890																																																																																																														
	3	01234567890																																																																																																														
	4	01234567890																																																																																																														
	Axis	Torque limit stored value	Near point	Upper limit	Lower limit																																																																																																											
	1	012 (%)	●	●	●																																																																																																											
	2	012 (%)	●	●	●																																																																																																											
	3	012 (%)	●	●	●																																																																																																											
4	012 (%)	●	●	●																																																																																																												
	2)	826, 926, 1026, 1126	033A, 039E, 0402, 0466																																																																																																													
	3)	816, 916, 1016, 1116	0330, 0394, 03F8, 045C																																																																																																													
	4)																																																																																																															
	5)																																																																																																															
<p>QD75M Speed-position control</p> <p>SPSC positioning amount</p> <table border="1"> <tr> <th>Axis</th> <th>Amount</th> </tr> <tr> <td>Axis1</td> <td>01234567890</td> </tr> <tr> <td>Axis2</td> <td>01234567890</td> </tr> <tr> <td>Axis3</td> <td>01234567890</td> </tr> <tr> <td>Axis4</td> <td>01234567890</td> </tr> </table> <p>(μm):*10⁴ (degree):*10³ (inch):*10³ (pulse):*1</p> <p>SPSC movement amount change register</p> <table border="1"> <tr> <th>Axis</th> <th>Register</th> </tr> <tr> <td>Axis1</td> <td>0123456789</td> </tr> <tr> <td>Axis2</td> <td>0123456789</td> </tr> <tr> <td>Axis3</td> <td>0123456789</td> </tr> <tr> <td>Axis4</td> <td>0123456789</td> </tr> </table> <p>Setting range 0 to 2147483647 (μm):*10⁴ (inch):*10³ (degree):*10³ (pulse):*1</p> <p>Item</p> <table border="1"> <tr> <th>Item</th> <th>Axis1</th> <th>Axis2</th> <th>Axis3</th> <th>Axis4</th> </tr> <tr> <td>Speed-position switching latch</td> <td>●</td> <td>●</td> <td>●</td> <td>●</td> </tr> <tr> <td>In speed control</td> <td>●</td> <td>●</td> <td>●</td> <td>●</td> </tr> <tr> <td>Speed-position switching enable</td> <td>0</td> <td>0</td> <td>0</td> <td>0</td> </tr> </table> <p>0:Disable 1:Enable</p>	Axis	Amount	Axis1	01234567890	Axis2	01234567890	Axis3	01234567890	Axis4	01234567890	Axis	Register	Axis1	0123456789	Axis2	0123456789	Axis3	0123456789	Axis4	0123456789	Item	Axis1	Axis2	Axis3	Axis4	Speed-position switching latch	●	●	●	●	In speed control	●	●	●	●	Speed-position switching enable	0	0	0	0	1)	814 to 815 914 to 915 1014 to 1015 1114 to 1115	032E to 032F 0392 to 0393 03F6 to 03F7 045A to 045B																																																																					
	Axis	Amount																																																																																																														
	Axis1	01234567890																																																																																																														
	Axis2	01234567890																																																																																																														
	Axis3	01234567890																																																																																																														
	Axis4	01234567890																																																																																																														
	Axis	Register																																																																																																														
	Axis1	0123456789																																																																																																														
	Axis2	0123456789																																																																																																														
	Axis3	0123456789																																																																																																														
	Axis4	0123456789																																																																																																														
	Item	Axis1	Axis2	Axis3	Axis4																																																																																																											
	Speed-position switching latch	●	●	●	●																																																																																																											
	In speed control	●	●	●	●																																																																																																											
	Speed-position switching enable	0	0	0	0																																																																																																											
	2)	1526 to 1527 1626 to 1627 1726 to 1727 1826 to 1827	05F6 to 05F7 065A to 065B 06BE to 06BF 0722 to 0723																																																																																																													
	3)	817, 917, 1017, 1117	0331, 0395, 03F9, 045D																																																																																																													
	4)	817, 917, 1017, 1117	0331, 0395, 03F9, 045D																																																																																																													
	5)	1528, 1628, 1728, 1828	05F8, 065C, 06C0, 0724																																																																																																													

Screen Image	No.	Buffer memory address																																																																	
		dec.	hex.																																																																
<p>QD75M Position-speed control</p> <p>Position-speed change register</p> <table border="1"> <tr> <td>Axis1</td> <td>0123456789</td> <td>Axis2</td> <td>0123456789</td> </tr> <tr> <td>Axis3</td> <td>0123456789</td> <td>Axis4</td> <td>0123456789</td> </tr> </table> <p>Setting range</p> <p>1 to 2000000000 (mm/min):*10⁻⁴ (inch/min):*10⁻⁴ (degree/min):*10⁻⁴ 1 to 100000000 (pulse/sec):*1</p> <table border="1"> <tr> <th>Item</th> <th>Axis1</th> <th>Axis2</th> <th>Axis3</th> <th>Axis4</th> </tr> <tr> <td>Position-speed switching latch</td> <td><input type="checkbox"/></td> <td><input type="checkbox"/></td> <td><input type="checkbox"/></td> <td><input type="checkbox"/></td> </tr> <tr> <td>In speed control</td> <td><input type="checkbox"/></td> <td><input type="checkbox"/></td> <td><input type="checkbox"/></td> <td><input type="checkbox"/></td> </tr> <tr> <td>Position-speed switching enable</td> <td>0</td> <td>0</td> <td>0</td> <td>0</td> </tr> <tr> <td></td> <td colspan="4">0:Disable 1:Enable</td> </tr> </table>	Axis1	0123456789	Axis2	0123456789	Axis3	0123456789	Axis4	0123456789	Item	Axis1	Axis2	Axis3	Axis4	Position-speed switching latch	<input type="checkbox"/>	<input type="checkbox"/>	<input type="checkbox"/>	<input type="checkbox"/>	In speed control	<input type="checkbox"/>	<input type="checkbox"/>	<input type="checkbox"/>	<input type="checkbox"/>	Position-speed switching enable	0	0	0	0		0:Disable 1:Enable				1)	1530 to 1531	05FA to 05FB																															
	Axis1	0123456789	Axis2	0123456789																																																															
	Axis3	0123456789	Axis4	0123456789																																																															
	Item	Axis1	Axis2	Axis3	Axis4																																																														
	Position-speed switching latch	<input type="checkbox"/>	<input type="checkbox"/>	<input type="checkbox"/>	<input type="checkbox"/>																																																														
	In speed control	<input type="checkbox"/>	<input type="checkbox"/>	<input type="checkbox"/>	<input type="checkbox"/>																																																														
	Position-speed switching enable	0	0	0	0																																																														
		0:Disable 1:Enable																																																																	
			1630 to 1631	065E to 065F																																																															
			1730 to 1731	06C2 to 06C3																																																															
		1830 to 1831	0726 to 0727																																																																
	2)	817, 917, 1017, 1117	0331, 0395, 03F9, 045D																																																																
	3)	817, 917, 1017, 1117	0331, 0395, 03F9, 045D																																																																
	4)	1532, 1632, 1732, 1832	05FC, 0660, 06C4, 0728																																																																
		---	---																																																																
<p>QD75M Axis control data-1</p> <p>New current value</p> <table border="1"> <tr> <td>Axis1</td> <td>01234567890</td> <td>Axis2</td> <td>01234567890</td> </tr> <tr> <td>Axis3</td> <td>01234567890</td> <td>Axis4</td> <td>01234567890</td> </tr> </table> <p>Setting range</p> <p>-2147483648 (um):*10⁻¹ to 2147483647 (inch):*10⁻⁴ (pulse):*1 0 to 359999999 (degree):*10⁻⁴</p> <table border="1"> <tr> <th>Item</th> <th>Axis1</th> <th>Axis2</th> <th>Axis3</th> <th>Axis4</th> <th>Set value</th> </tr> <tr> <td>Torg.boost</td> <td>012</td> <td>012</td> <td>012</td> <td>012</td> <td>1 to 300(%)</td> </tr> <tr> <td>Step mode</td> <td>0</td> <td>0</td> <td>0</td> <td>0</td> <td>0:Dec.unit 1:data No.</td> </tr> <tr> <td>Step valid flag</td> <td>0</td> <td>0</td> <td>0</td> <td>0</td> <td>0:Invalid 1:Valid</td> </tr> <tr> <td>Step start information</td> <td>0</td> <td>0</td> <td>0</td> <td>0</td> <td>0:Restarts 1:Continues</td> </tr> </table> <p>New speed value</p> <table border="1"> <tr> <td>Axis1</td> <td>01234567890</td> <td>Axis2</td> <td>01234567890</td> </tr> <tr> <td>Axis3</td> <td>01234567890</td> <td>Axis4</td> <td>01234567890</td> </tr> </table> <p>Setting range</p> <p>0 to 2000000000 (mm/min):*10⁻⁴ (inch/min):*10⁻⁴ (degree/min):*10⁻⁴ 0 to 100000000 (pulse/sec):*1</p> <table border="1"> <tr> <th>Item</th> <th>Axis1</th> <th>Axis2</th> <th>Axis3</th> <th>Axis4</th> <th>Set value</th> </tr> <tr> <td>Skip command</td> <td>0</td> <td>0</td> <td>0</td> <td>0</td> <td>0:Restarts 1:Continues</td> </tr> <tr> <td>Use ext. command</td> <td>0</td> <td>0</td> <td>0</td> <td>0</td> <td>0:Invalid 1:Valid</td> </tr> </table>	Axis1	01234567890	Axis2	01234567890	Axis3	01234567890	Axis4	01234567890	Item	Axis1	Axis2	Axis3	Axis4	Set value	Torg.boost	012	012	012	012	1 to 300(%)	Step mode	0	0	0	0	0:Dec.unit 1:data No.	Step valid flag	0	0	0	0	0:Invalid 1:Valid	Step start information	0	0	0	0	0:Restarts 1:Continues	Axis1	01234567890	Axis2	01234567890	Axis3	01234567890	Axis4	01234567890	Item	Axis1	Axis2	Axis3	Axis4	Set value	Skip command	0	0	0	0	0:Restarts 1:Continues	Use ext. command	0	0	0	0	0:Invalid 1:Valid	1)	1506 to 1507	05E2 to 05E3
	Axis1	01234567890	Axis2	01234567890																																																															
	Axis3	01234567890	Axis4	01234567890																																																															
	Item	Axis1	Axis2	Axis3	Axis4	Set value																																																													
	Torg.boost	012	012	012	012	1 to 300(%)																																																													
	Step mode	0	0	0	0	0:Dec.unit 1:data No.																																																													
	Step valid flag	0	0	0	0	0:Invalid 1:Valid																																																													
	Step start information	0	0	0	0	0:Restarts 1:Continues																																																													
	Axis1	01234567890	Axis2	01234567890																																																															
	Axis3	01234567890	Axis4	01234567890																																																															
	Item	Axis1	Axis2	Axis3	Axis4	Set value																																																													
	Skip command	0	0	0	0	0:Restarts 1:Continues																																																													
	Use ext. command	0	0	0	0	0:Invalid 1:Valid																																																													
			1606 to 1607	0646 to 0647																																																															
			1706 to 1707	06AA to 06AB																																																															
			1806 to 1807	070E to 070F																																																															
	2)	1514 to 1515	05EA to 05EB																																																																
		1614 to 1615	064E to 064F																																																																
		1714 to 1715	06B2 to 06B3																																																																
		1814 to 1815	0716 to 0717																																																																
	3)	1513, 1613, 1713, 1813	05E9, 064D, 06B1, 0715																																																																
	4)	1544, 1644, 1744, 1844	0608, 066C, 06D0, 0734																																																																
	5)	1545, 1645, 1745, 1845	0609, 066D, 06D1, 0735																																																																
	6)	1546, 1646, 1746, 1846	060A, 066E, 06D2, 0736																																																																
	7)	1547, 1647, 1747, 1847	060B, 066F, 06D3, 0737																																																																
	8)	1505, 1605, 1705, 1805	05E1, 0645, 06A9, 070D																																																																

Screen Image		No.	Buffer memory address	
			dec.	hex.
		1)	1500, 1600, 1700, 1800	05DC, 0640, 06A4, 0708
		2)	1501, 1601, 1701, 1801	05DD, 0641, 06A5, 0709
		3)	1502, 1602, 1702, 1802	05DE, 0642, 06A6, 070A
		4)	1503, 1603, 1703, 1803	05DF, 0643, 06A7, 070B
		5)	1504, 1604, 1704, 1804	05E0, 0644, 06A8, 070C
		6)	1512, 1612, 1712, 1812	05E8, 064C, 06B0, 0714
		7)	1516, 1616, 1716, 1816	05EC, 0650, 06B4, 0718
		8)	1508 to 1509	05E4 to 05E5
			1608 to 1609	0648 to 0649
			1708 to 1709	06AC to 06AD
			1808 to 1809	0710 to 0711
		9)	1510 to 1511	05E6 to 05E7
			1610 to 1611	064A to 064B
			1710 to 1711	06AE to 06AF
10)	1512 to 1513	05E8 to 05E9		
	1612 to 1613	064C to 064D		
	1712 to 1713	06B0 to 06B1		
10)	1520, 1620, 1720, 1820	05F0, 0654, 06B8, 071C		
11)	1521, 1621, 1721, 1821	05F1, 0655, 06B9, 071D		
12)	1522 to 1523	05F2 to 05F3		
	1622 to 1623	0656 to 0657		
	1722 to 1723	06BA to 06BB		
13)	1524, 1624, 1724, 1824	05F4, 0658, 06BC, 0720		
	1525, 1625, 1725, 1825	05F5, 0659, 06BD, 0721		
		1)	1538, 1638, 1738, 1838	0602, 0666, 06CA, 072E
		2)	1548, 1648, 1748, 1848	060C, 0670, 06D4, 0738
		3)	1549, 1649, 1749, 1849	060D, 0671, 06D5, 0739
		4)	1550, 1650, 1750, 1850	060E, 0672, 06D6, 073A
		5)	1540, 1640, 1740, 1840, 1541, 1641, 1741, 1841, 1542, 1642, 1742, 1842, 1543, 1643, 1743, 1843	0604, 0668, 06CC, 0730, 0605, 0669, 06CD, 0731, 0606, 066A, 06CE, 0732, 0607, 066B, 06CF, 0733

Screen Image		No.	Buffer memory address																																																																																																																																																																
			dec.	hex.																																																																																																																																																															
<p>QD75M Axis control data-4</p> <table border="1"> <tr> <th colspan="4">Inching movement amount</th> <th colspan="4">Target position change value (Address)</th> </tr> <tr> <td>Axis1</td><td>01234</td><td>Axis2</td><td>01234</td> <td>Axis1</td><td>0123456789</td><td>Axis2</td><td>0123456789</td> </tr> <tr> <td>Axis3</td><td>01234</td><td>Axis4</td><td>01234</td> <td>Axis3</td><td>0123456789</td><td>Axis4</td><td>0123456789</td> </tr> <tr> <td>Setting range</td><td colspan="3">1 to 65535 (mm):*10⁻⁴ [inch]:*10⁻⁴ (degree):*10⁻⁴ [pulse]:*1</td> <td>Setting range</td><td colspan="3">ABS-INC -2147483648 to 2147483647 (μm):*10⁻⁴ (inch):*10⁻⁴ (degree):*10⁻⁴ (pulse):*1 (*ABS 0to3599999(degree):*10⁻⁴)</td> </tr> </table> <table border="1"> <tr> <th colspan="4">JOG speed</th> <th colspan="4">Target position change value (Speed)</th> </tr> <tr> <td>Axis1</td><td>0123456789</td><td>Axis2</td><td>0123456789</td> <td>Axis1</td><td>0123456789</td><td>Axis2</td><td>0123456789</td> </tr> <tr> <td>Axis3</td><td>0123456789</td><td>Axis4</td><td>0123456789</td> <td>Axis3</td><td>0123456789</td><td>Axis4</td><td>0123456789</td> </tr> <tr> <td>Setting range</td><td colspan="3">0 to 2000000000 (mm/min):*10⁻² (inch/min):*10⁻² (degree/min):*10⁻²</td> <td>Setting range</td><td colspan="3">0 to 2000000000 (mm/min):*10⁻² (inch/min):*10⁻² (degree/min):*10⁻²</td> </tr> <tr> <td></td><td colspan="3">0 to 100000000(pulse/sec):*1</td> <td></td><td colspan="3">0 to 100000000 (pulse/sec):*1</td> </tr> </table>	Inching movement amount				Target position change value (Address)				Axis1	01234	Axis2	01234	Axis1	0123456789	Axis2	0123456789	Axis3	01234	Axis4	01234	Axis3	0123456789	Axis4	0123456789	Setting range	1 to 65535 (mm):*10 ⁻⁴ [inch]:*10 ⁻⁴ (degree):*10 ⁻⁴ [pulse]:*1			Setting range	ABS-INC -2147483648 to 2147483647 (μm):*10 ⁻⁴ (inch):*10 ⁻⁴ (degree):*10 ⁻⁴ (pulse):*1 (*ABS 0to3599999(degree):*10 ⁻⁴)			JOG speed				Target position change value (Speed)				Axis1	0123456789	Axis2	0123456789	Axis1	0123456789	Axis2	0123456789	Axis3	0123456789	Axis4	0123456789	Axis3	0123456789	Axis4	0123456789	Setting range	0 to 2000000000 (mm/min):*10 ⁻² (inch/min):*10 ⁻² (degree/min):*10 ⁻²			Setting range	0 to 2000000000 (mm/min):*10 ⁻² (inch/min):*10 ⁻² (degree/min):*10 ⁻²				0 to 100000000(pulse/sec):*1				0 to 100000000 (pulse/sec):*1			1)	1517, 1617, 1717, 1817	05ED, 0651, 06B5, 0719																																																																																								
	Inching movement amount				Target position change value (Address)																																																																																																																																																														
	Axis1	01234	Axis2	01234	Axis1	0123456789	Axis2	0123456789																																																																																																																																																											
	Axis3	01234	Axis4	01234	Axis3	0123456789	Axis4	0123456789																																																																																																																																																											
	Setting range	1 to 65535 (mm):*10 ⁻⁴ [inch]:*10 ⁻⁴ (degree):*10 ⁻⁴ [pulse]:*1			Setting range	ABS-INC -2147483648 to 2147483647 (μm):*10 ⁻⁴ (inch):*10 ⁻⁴ (degree):*10 ⁻⁴ (pulse):*1 (*ABS 0to3599999(degree):*10 ⁻⁴)																																																																																																																																																													
	JOG speed				Target position change value (Speed)																																																																																																																																																														
	Axis1	0123456789	Axis2	0123456789	Axis1	0123456789	Axis2	0123456789																																																																																																																																																											
	Axis3	0123456789	Axis4	0123456789	Axis3	0123456789	Axis4	0123456789																																																																																																																																																											
	Setting range	0 to 2000000000 (mm/min):*10 ⁻² (inch/min):*10 ⁻² (degree/min):*10 ⁻²			Setting range	0 to 2000000000 (mm/min):*10 ⁻² (inch/min):*10 ⁻² (degree/min):*10 ⁻²																																																																																																																																																													
		0 to 100000000(pulse/sec):*1				0 to 100000000 (pulse/sec):*1																																																																																																																																																													
		2)	1518 to 1519	05EE to 05EF																																																																																																																																																															
		3)	1618 to 1619	0652 to 0653																																																																																																																																																															
			1718 to 1719	06B6 to 06B7																																																																																																																																																															
			1818 to 1819	071A to 071B																																																																																																																																																															
		3)	1534 to 1535	05FE to 05FF																																																																																																																																																															
			1634 to 1635	0662 to 0663																																																																																																																																																															
		1734 to 1735	06C6 to 06C7																																																																																																																																																																
		1834 to 1835	072A to 072B																																																																																																																																																																
	4)	1536 to 1537	0600 to 0601																																																																																																																																																																
		1636 to 1637	0664 to 0665																																																																																																																																																																
		1736 to 1737	06C8 to 06C9																																																																																																																																																																
		1836 to 1837	072C to 072D																																																																																																																																																																
<p>QD75M Start History</p> <table border="1"> <tr> <th colspan="6">Start History (0 to 7)</th> </tr> <tr> <th>No.</th><th>Axis</th><th>Start</th><th>Kind</th><th>Time</th><th>Judge</th> </tr> <tr><td>0</td><td>01</td><td>Re 0123</td><td></td><td>00:00:00.00</td><td>012</td></tr> <tr><td>1</td><td>01</td><td>Re 0123</td><td></td><td>00:00:00.00</td><td>012</td></tr> <tr><td>2</td><td>01</td><td>Re 0123</td><td></td><td>00:00:00.00</td><td>012</td></tr> <tr><td>3</td><td>01</td><td>Re 0123</td><td></td><td>00:00:00.00</td><td>012</td></tr> <tr><td>4</td><td>01</td><td>Re 0123</td><td></td><td>00:00:00.00</td><td>012</td></tr> <tr><td>5</td><td>01</td><td>Re 0123</td><td></td><td>00:00:00.00</td><td>012</td></tr> <tr><td>6</td><td>01</td><td>Re 0123</td><td></td><td>00:00:00.00</td><td>012</td></tr> <tr><td>7</td><td>01</td><td>Re 0123</td><td></td><td>00:00:00.00</td><td>012</td></tr> </table> <table border="1"> <tr> <th colspan="6">Start History (8 to 15)</th> </tr> <tr> <th>No.</th><th>Axis</th><th>Start</th><th>Kind</th><th>Time</th><th>Judge</th> </tr> <tr><td>8</td><td>01</td><td>Re 0123</td><td></td><td>00:00:00.00</td><td>012</td></tr> <tr><td>9</td><td>01</td><td>Re 0123</td><td></td><td>00:00:00.00</td><td>012</td></tr> <tr><td>10</td><td>01</td><td>Re 0123</td><td></td><td>00:00:00.00</td><td>012</td></tr> <tr><td>11</td><td>01</td><td>Re 0123</td><td></td><td>00:00:00.00</td><td>012</td></tr> <tr><td>12</td><td>01</td><td>Re 0123</td><td></td><td>00:00:00.00</td><td>012</td></tr> <tr><td>13</td><td>01</td><td>Re 0123</td><td></td><td>00:00:00.00</td><td>012</td></tr> <tr><td>14</td><td>01</td><td>Re 0123</td><td></td><td>00:00:00.00</td><td>012</td></tr> <tr><td>15</td><td>01</td><td>Re 0123</td><td></td><td>00:00:00.00</td><td>012</td></tr> </table>	Start History (0 to 7)						No.	Axis	Start	Kind	Time	Judge	0	01	Re 0123		00:00:00.00	012	1	01	Re 0123		00:00:00.00	012	2	01	Re 0123		00:00:00.00	012	3	01	Re 0123		00:00:00.00	012	4	01	Re 0123		00:00:00.00	012	5	01	Re 0123		00:00:00.00	012	6	01	Re 0123		00:00:00.00	012	7	01	Re 0123		00:00:00.00	012	Start History (8 to 15)						No.	Axis	Start	Kind	Time	Judge	8	01	Re 0123		00:00:00.00	012	9	01	Re 0123		00:00:00.00	012	10	01	Re 0123		00:00:00.00	012	11	01	Re 0123		00:00:00.00	012	12	01	Re 0123		00:00:00.00	012	13	01	Re 0123		00:00:00.00	012	14	01	Re 0123		00:00:00.00	012	15	01	Re 0123		00:00:00.00	012	1)	1212 to 1292	04BC to 050C																																								
	Start History (0 to 7)																																																																																																																																																																		
No.	Axis	Start	Kind	Time	Judge																																																																																																																																																														
0	01	Re 0123		00:00:00.00	012																																																																																																																																																														
1	01	Re 0123		00:00:00.00	012																																																																																																																																																														
2	01	Re 0123		00:00:00.00	012																																																																																																																																																														
3	01	Re 0123		00:00:00.00	012																																																																																																																																																														
4	01	Re 0123		00:00:00.00	012																																																																																																																																																														
5	01	Re 0123		00:00:00.00	012																																																																																																																																																														
6	01	Re 0123		00:00:00.00	012																																																																																																																																																														
7	01	Re 0123		00:00:00.00	012																																																																																																																																																														
Start History (8 to 15)																																																																																																																																																																			
No.	Axis	Start	Kind	Time	Judge																																																																																																																																																														
8	01	Re 0123		00:00:00.00	012																																																																																																																																																														
9	01	Re 0123		00:00:00.00	012																																																																																																																																																														
10	01	Re 0123		00:00:00.00	012																																																																																																																																																														
11	01	Re 0123		00:00:00.00	012																																																																																																																																																														
12	01	Re 0123		00:00:00.00	012																																																																																																																																																														
13	01	Re 0123		00:00:00.00	012																																																																																																																																																														
14	01	Re 0123		00:00:00.00	012																																																																																																																																																														
15	01	Re 0123		00:00:00.00	012																																																																																																																																																														
<p>QD75M Error & Warning History</p> <table border="1"> <tr> <th colspan="4">Error History (0 to 7)</th> <th colspan="4">Warning History (0 to 7)</th> </tr> <tr> <th>No.</th><th>Axis</th><th>Code</th><th>Time</th> <th>No.</th><th>Axis</th><th>Code</th><th>Time</th> </tr> <tr><td>0</td><td>012</td><td></td><td>00:00:00.00</td><td>0</td><td>012</td><td></td><td>00:00:00.00</td></tr> <tr><td>1</td><td>012</td><td></td><td>00:00:00.00</td><td>1</td><td>012</td><td></td><td>00:00:00.00</td></tr> <tr><td>2</td><td>012</td><td></td><td>00:00:00.00</td><td>2</td><td>012</td><td></td><td>00:00:00.00</td></tr> <tr><td>3</td><td>012</td><td></td><td>00:00:00.00</td><td>3</td><td>012</td><td></td><td>00:00:00.00</td></tr> <tr><td>4</td><td>012</td><td></td><td>00:00:00.00</td><td>4</td><td>012</td><td></td><td>00:00:00.00</td></tr> <tr><td>5</td><td>012</td><td></td><td>00:00:00.00</td><td>5</td><td>012</td><td></td><td>00:00:00.00</td></tr> <tr><td>6</td><td>012</td><td></td><td>00:00:00.00</td><td>6</td><td>012</td><td></td><td>00:00:00.00</td></tr> <tr><td>7</td><td>012</td><td></td><td>00:00:00.00</td><td>7</td><td>012</td><td></td><td>00:00:00.00</td></tr> </table> <table border="1"> <tr> <th colspan="4">Error History (8 to 15)</th> <th colspan="4">Warning History (8 to 15)</th> </tr> <tr> <th>No.</th><th>Axis</th><th>Code</th><th>Time</th> <th>No.</th><th>Axis</th><th>Code</th><th>Time</th> </tr> <tr><td>8</td><td>012</td><td></td><td>00:00:00.00</td><td>8</td><td>012</td><td></td><td>00:00:00.00</td></tr> <tr><td>9</td><td>012</td><td></td><td>00:00:00.00</td><td>9</td><td>012</td><td></td><td>00:00:00.00</td></tr> <tr><td>10</td><td>012</td><td></td><td>00:00:00.00</td><td>10</td><td>012</td><td></td><td>00:00:00.00</td></tr> <tr><td>11</td><td>012</td><td></td><td>00:00:00.00</td><td>11</td><td>012</td><td></td><td>00:00:00.00</td></tr> <tr><td>12</td><td>012</td><td></td><td>00:00:00.00</td><td>12</td><td>012</td><td></td><td>00:00:00.00</td></tr> <tr><td>13</td><td>012</td><td></td><td>00:00:00.00</td><td>13</td><td>012</td><td></td><td>00:00:00.00</td></tr> <tr><td>14</td><td>012</td><td></td><td>00:00:00.00</td><td>14</td><td>012</td><td></td><td>00:00:00.00</td></tr> <tr><td>15</td><td>012</td><td></td><td>00:00:00.00</td><td>15</td><td>012</td><td></td><td>00:00:00.00</td></tr> </table>	Error History (0 to 7)				Warning History (0 to 7)				No.	Axis	Code	Time	No.	Axis	Code	Time	0	012		00:00:00.00	0	012		00:00:00.00	1	012		00:00:00.00	1	012		00:00:00.00	2	012		00:00:00.00	2	012		00:00:00.00	3	012		00:00:00.00	3	012		00:00:00.00	4	012		00:00:00.00	4	012		00:00:00.00	5	012		00:00:00.00	5	012		00:00:00.00	6	012		00:00:00.00	6	012		00:00:00.00	7	012		00:00:00.00	7	012		00:00:00.00	Error History (8 to 15)				Warning History (8 to 15)				No.	Axis	Code	Time	No.	Axis	Code	Time	8	012		00:00:00.00	8	012		00:00:00.00	9	012		00:00:00.00	9	012		00:00:00.00	10	012		00:00:00.00	10	012		00:00:00.00	11	012		00:00:00.00	11	012		00:00:00.00	12	012		00:00:00.00	12	012		00:00:00.00	13	012		00:00:00.00	13	012		00:00:00.00	14	012		00:00:00.00	14	012		00:00:00.00	15	012		00:00:00.00	15	012		00:00:00.00	1)	1293 to 1356	050D to 054C
	Error History (0 to 7)				Warning History (0 to 7)																																																																																																																																																														
	No.	Axis	Code	Time	No.	Axis	Code	Time																																																																																																																																																											
	0	012		00:00:00.00	0	012		00:00:00.00																																																																																																																																																											
1	012		00:00:00.00	1	012		00:00:00.00																																																																																																																																																												
2	012		00:00:00.00	2	012		00:00:00.00																																																																																																																																																												
3	012		00:00:00.00	3	012		00:00:00.00																																																																																																																																																												
4	012		00:00:00.00	4	012		00:00:00.00																																																																																																																																																												
5	012		00:00:00.00	5	012		00:00:00.00																																																																																																																																																												
6	012		00:00:00.00	6	012		00:00:00.00																																																																																																																																																												
7	012		00:00:00.00	7	012		00:00:00.00																																																																																																																																																												
Error History (8 to 15)				Warning History (8 to 15)																																																																																																																																																															
No.	Axis	Code	Time	No.	Axis	Code	Time																																																																																																																																																												
8	012		00:00:00.00	8	012		00:00:00.00																																																																																																																																																												
9	012		00:00:00.00	9	012		00:00:00.00																																																																																																																																																												
10	012		00:00:00.00	10	012		00:00:00.00																																																																																																																																																												
11	012		00:00:00.00	11	012		00:00:00.00																																																																																																																																																												
12	012		00:00:00.00	12	012		00:00:00.00																																																																																																																																																												
13	012		00:00:00.00	13	012		00:00:00.00																																																																																																																																																												
14	012		00:00:00.00	14	012		00:00:00.00																																																																																																																																																												
15	012		00:00:00.00	15	012		00:00:00.00																																																																																																																																																												
	2)	1358 to 1421	054E to 058D																																																																																																																																																																

Screen Image		No.	Buffer memory address	
			dec.	hex.
		1)	2000 to 25999	07D0 to 658F
		1)	30100, 30200, 30300, 30400	07594, 075F8, 0765C, 076C0
		2)	30101, 30201, 30301, 30401	07595, 075F9, 0765D, 076C1
		3)	30102, 30202, 30302, 30402	07596, 075FA, 0765E, 076C2
		4)	30103, 30203, 30303, 30403	07597, 075FB, 0765F, 076C3
		5)	30104, 30204, 30304, 30404	07598, 075FC, 07660, 076C4
		6)	30105, 30205, 30305, 30405	07599, 075FD, 07661, 076C5
		7)	30106, 30206, 30306, 30406	0759A, 075FE, 07662, 076C6
		8)	30107, 30207, 30307, 30407	0759B, 075FF, 07663, 076C7
		9)	30108, 30208, 30308, 30408	0759C, 07600, 07664, 076C8
		10)	30109, 30209, 30309, 30409	0759D, 07601, 07665, 076C9
		11)		

Screen Image		No.	Buffer memory address	
			dec.	hex.
<p>QD75M Servo regulation parameter(Part1)</p> <p>1) Position loop gain1 4 - 2000[rad/s] Load inertia $\times 10^{-1}$ Axis1 0123 Axis2 0123 Axis3 0123 Axis4 0123</p> <p>2) Speed loop gain1 20 - 8000[rad/s] Speed integral compensation1 - 1000[ms] Axis1 0123 Axis2 0123 Axis3 0123 Axis4 0123</p> <p>3) Position loop gain2 1 - 1000[rad/s] Feed forward gain 0 - 100[%] Axis1 0123 Axis2 0123 Axis3 0123 Axis4 0123</p> <p>4) Speed loop gain2 20 - 20000[rad/s] In-position range E-brake sequence Axis1 01234 Axis2 01234 0 - 50000[PLS] 0 - 1000[ms] Axis3 01234 Axis4 01234 Ax.1 01234 Ax.2 01234 Ax.1 0123 Ax.2 0123 Ax.3 01234 Ax.4 01234 Ax.3 0123 Ax.4 0123</p> <p>Notch filter MON. output</p> <p>10) Notch filter Axis1 0 Axis2 0 Axis3 0 Axis4 0 Notch depth Axis1 0 Axis2 0 Axis3 0 Axis4 0</p>		1)	30113, 30213, 30313, 30413	075A1, 07605 07669, 076CD
		2)	30114, 30214, 30314, 30414	075A2, 07606 0766A, 076CE
		3)	30115, 30215, 30315, 30415	075A3, 07607 0766B, 076CF
		4)	30116, 30216, 30316, 30416	075A4, 07608 0766C, 076D0
		5)	30112, 30212, 30312, 30412	075A0, 07604 07668, 076CC
		6)	30117, 30217, 30317, 30417	075A5, 07609 0766D, 076D1
		7)	30119, 30219, 30319, 30419	075A7, 0760B 0766F, 076D3
		8)	30120, 30220, 30320, 30420	075A8, 0760C 07670, 076D4
		9)	30121, 30221, 30321, 30421	075A9, 0760D 07671, 076D5
		10)	30118, 30218, 30318, 30418	075A6, 0760A 0766E, 076D2
		11)	30122, 30222, 30322, 30422	075AA, 0760E 07672, 076D6
<p>QD75M Servo regulation parameter(Part2)</p> <p>1) Servo forced stop Electro magnetic brake interlock output 0:Valid 1:Invalid 0:No relation to servo motor speed. Axis1 0 Axis2 0 Axis3 0 Axis4 0 1:Output in any statuses when the motor speed is less than Zero speed.</p> <p>2) Low acoustic noise mode 0:2.5KHz 1:--- 2:6.375KHz 3:9KHz Axis1 0 Axis2 0 Axis3 0 Axis4 0</p> <p>3) Serial encoder cable 0: 2 line method 1: 4 line method Axis1 0 Axis2 0 Axis3 0 Axis4 0</p> <p>4) Slight vibration suppression control Low pass filter 0:Invalid 1:Valid 0:Automatic control 1:Manual Axis1 0 Axis2 0 Axis3 0 Axis4 0</p> <p>5) Motor-less operation Adaptive vibration control 0:Invalid 1:Valid 2:Maintenance Axis1 0 Axis2 0 Axis3 0 Axis4 0 Adaptive vibration control sensitivity 0:Normal 1:Very sensitive Axis1 0 Axis2 0 Axis3 0 Axis4 0</p>		1)	30123, 30223, 30323, 30423	075AB, 0760F 07673, 076D7
		2)	30124, 30224, 30324, 30424	075AC, 07610 07674, 076D8
		3)	30125, 30225, 30325, 30425	075AD, 07611 07675, 076D9
		4)	---	---
		5)	---	---
		6)	---	---
		7)	---	---
		8)	---	---
		9)	---	---

Screen Image		No.	Buffer memory address	
			dec.	hex.
<p>QD75M Servo extended parameter(Part1)</p> <p>Analog monitor offset -9999 - 9999</p> <p>Analog monitor 1 Axis1 01234 Axis2 01234 offset Axis3 01234 Axis4 01234</p> <p>Analog monitor 2 Axis1 01234 Axis2 01234 offset Axis3 01234 Axis4 01234</p> <p>Alarm data sampling time 0:1.77[ms] 1:3.55[ms] 2:7.11[ms] 3:14.22[ms] 4:28.44[ms] Axis1 0 Axis2 0 Axis3 0 Axis4 0</p> <p>Pre-alarm data 0:Speed 1:Torque 2:Speed 3:Torque 4:Command current output 5:Command F delta T 6:Droop pulses1/1 7:Droop pulses1/4 8:Droop pulses1/16 9:Droop pulses1/32 A:Droop pulses1/64 data 1 Axis1 0 Axis2 0 Axis3 0 Axis4 0 data 2 Axis1 0 Axis2 0 Axis3 0 Axis4 0</p> <p>zero speed 0 - 10000[r/min] Axis1 01234 Axis2 01234 Axis3 01234 Axis4 01234</p> <p>Error excessive alarm level 1 - 1000[Kpls], 0.1 - 100.0[rev] (MR-J2S-B) Axis1 0123 Axis2 0123 Axis3 0123 Axis4 0123</p> <p>PI-PID control switch-over 0:Invalid 1:Droop-based switching is valid in position control 2:PID control is always valid Axis1 0 Axis2 0 Axis3 0 Axis4 0</p> <p>Servo retrieve character 0:Japanese 1:English Axis1 0 Axis2 0 Axis3 0 Axis4 0</p>		1)	30127, 30227, 30327, 30427	075AF, 07613 07677, 076DB
		2)	30128, 30228, 30328, 30428	075B0, 07614 07678, 076DC
		3)	30129, 30229,	075B1, 07615
		4)	30329, 30429	07679, 076DD
		5)	30130, 30230, 30330, 30430	075B2, 07616 0767A, 076DE
		6)	30131, 30231, 30331, 30431	075B3, 07617 0767B, 076DF
		7)	30132, 30232,	075B4, 07618
		8)	30332, 30432	0767C, 076E0
<p>QD75M Servo extended parameter(Part2)</p> <p>Serial communication baudrate 0: 9600 [bps] 1:19200 [bps] 2:38400 [bps] 3:57600 [bps] Axis1 0 Axis2 0 Axis3 0 Axis4 0</p> <p>Serial communication response delay 0:Invalid 1:Valid Axis1 0 Axis2 0 Axis3 0 Axis4 0</p> <p>Encoder output pulse setting 0:Output pulse setting 1:Division ratio setting Axis1 0 Axis2 0 Axis3 0 Axis4 0</p> <p>PI-PID control switch-over 0 - 50000[PLS] Ax.1 01234 Ax.2 01234 Ax.3 01234 Ax.4 01234</p> <p>Speed differential compensation 0 - 1000 Ax.1 0123 Ax.2 0123 Ax.3 0123 Ax.4 0123</p> <p>Encoder output pulses 0 - 65535 Ax.1 01234 Ax.2 01234 Ax.3 01234 Ax.4 01234</p>		1)	30133, 30233,	075B5, 07619
		2)	30333, 30433	0767D, 076E1
		3)	30134, 30234,	075B6, 0761A
		4)	30334, 30434	0767E, 076E2
		5)	30136, 30236, 30336, 30436	075B8, 0761C 07680, 076E4
		6)	30138, 30238, 30338, 30438	075BA, 0761E 07682, 076E6
		—	—	—

Screen Image	No.	Buffer memory address	
		dec.	hex.
	1)	30143, 30243, 30343, 30443	075BF, 07623 07687, 076EB
	2)	30144, 30244, 30344, 30444	075C0, 07624 07688, 076EC
	3)	30145, 30245, 30345, 30445	075C1, 07605 07689, 076ED
	4)	30149, 30249, 30349, 30449	075C5, 07629 0768D, 076F1
	5)	30150, 30250, 30350, 30450	075C6, 0762A 0768E, 076F2
	6)	30151, 30251, 30351, 30451	075C7, 0762B 0768F, 076F3
	7)	30152, 30252, 30352, 30452	075C8, 0762C 07690, 076F4
	8)	30153, 30253, 30353, 30453	075C9, 0762D 07691, 076F5
	9)	30154, 30254, 30354, 30454	075CA, 0762E 07692, 076F5
	10)	30155, 30255, 30355, 30455	075CB, 0762F 07693, 076F6
	11)	30160, 30260, 30360, 30460	075D0, 07634 07698, 076FC
	12)	30161, 30261, 30361, 30461	075D1, 07635 07699, 076FD

CHAPTER13 OPERATING I/O MODULE MONITOR SCREENS

This section explains how the various screens are operated in the special module monitor function, when monitoring input or output modules.

13.1 Specifying the module to be monitored

This describes how to start monitoring an optional special input or output module.

[Operation procedure]

Display the System Configuration screen. See Sec. 12.1.1.

Specify the module to be monitored (Touch the position at which the module is displayed.)

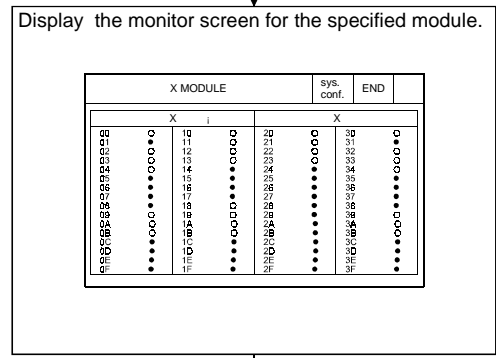

To Sec. 13.2

- (1) From among the modules installed in the corresponding base unit, specify the module whose "Input" or "Output" is displayed.
Refer to Section 12.1.3 for the way to specify the special function module.
- (2) For information on confirming the displayed contents and subsequent operation, please see Sec. 13.2.
* Tests cannot be conducted on input or output modules.

13.2 Monitor screen configuration and key functions

This section describes the configuration of monitor screens displayed by specifying the input module on the system configuration screen, and explains the functions of the keys displayed on the screen.

(1) Display (for an input module)

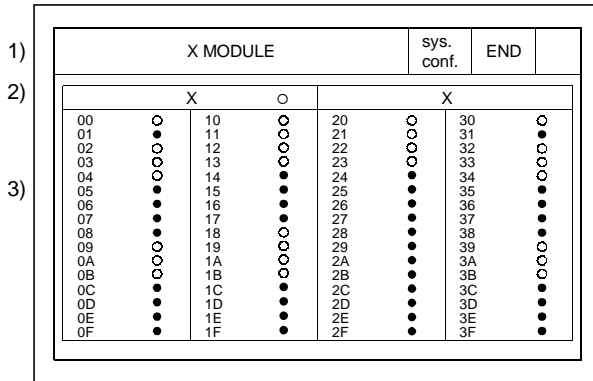

- 4) Displays the statuses of input and output signals after being read out from the corresponding module. (OS executes it automatically.)
- Statuses for up to 64 can be displayed.
- Signal statuses:
 ● : ON
 ○ : OFF

1)	Displays the type of the object module (input or output module).
2)	Displays the name of the signal being monitored (X or Y).
3)	Displays the number and status of the input or output signal.
4)	Displays keys that are used with the operation of the monitor screen shown in (2) (Touch input).

(2) Key functions

The chart below shows the functions of the keys that are used with the Monitor Screen operation.

Key	Function
END	Monitoring ends; and display returns to the screen where the special module monitor function was begun.
sys. conf.	The current monitoring ends; and returns to the system configuration screen.

CHAPTER14 ERROR DISPLAY AND HANDLING WITH SPECIAL MODULE MONITORING

The following chart shows the error messages that may be displayed when operating the special module monitor and the method of handling them.

Error message	Description	Method of Handling
Can not Communication	Communication could not be established with the PLC CPU.	(1) To try the operation again, touch "Retry". When the operation is retried, the error message disappears and monitoring resumes automatically, so no action is required. If monitoring is not resumed for a long period of time, however, check the following: 1) Connections between the PLC CPU and the GOT (disconnected or cut cables). 2) Has an error occurred in the PLC CPU? Etc.

CHAPTER15 OPERATING THE NETWORK MONITOR FUNCTION

This chapter describes how to operate the network monitor function.

15.1 Steps in getting started with the network monitor function

The following flowchart outlines how to transmit and install an operating system (OS) for the network monitor function in the GOT internal memory using the Personal computer.

For further information on screen displays and key operations, see the online help of the GT Designer.

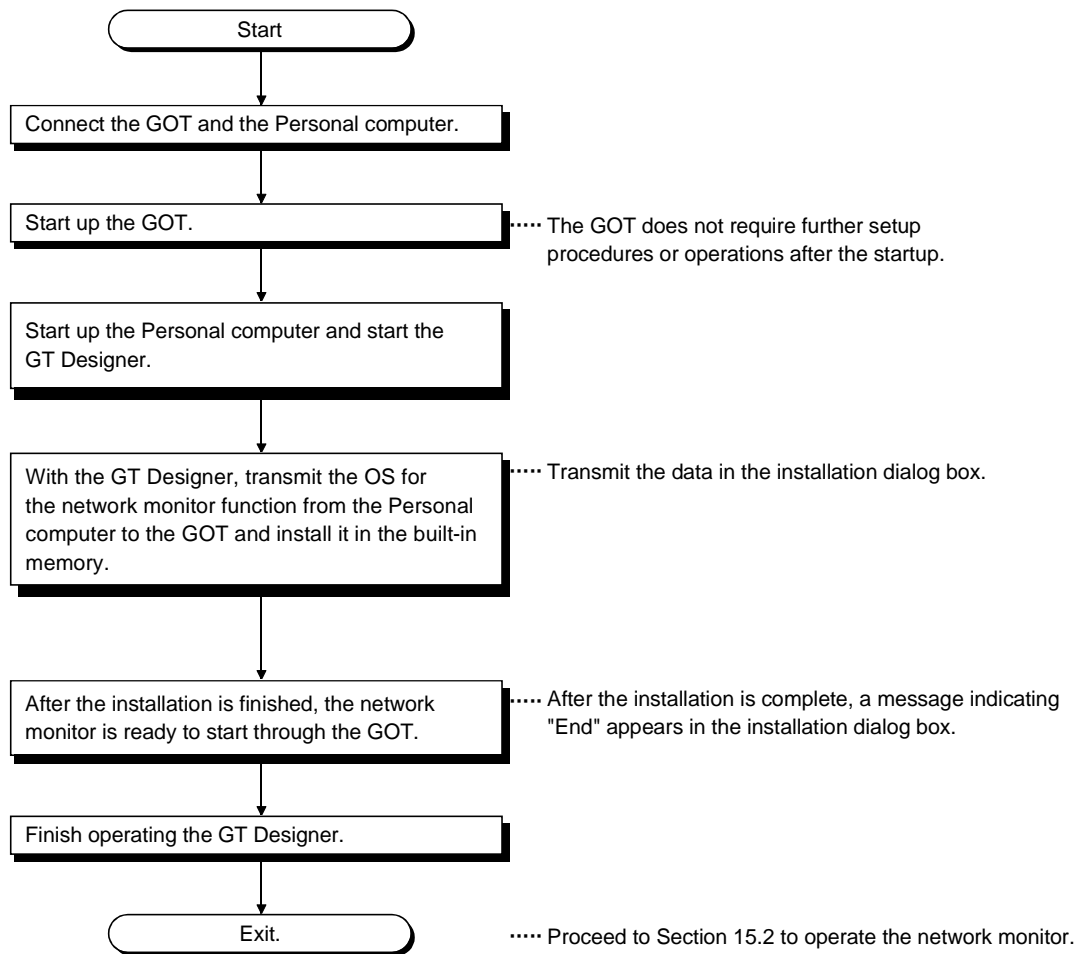

15.2 Steps in starting the network monitor function from the user-created monitor screen

The following flowchart outlines how to start the network monitor function after the operating system (OS) for the network monitor has been installed in the GOT built-in internal memory.

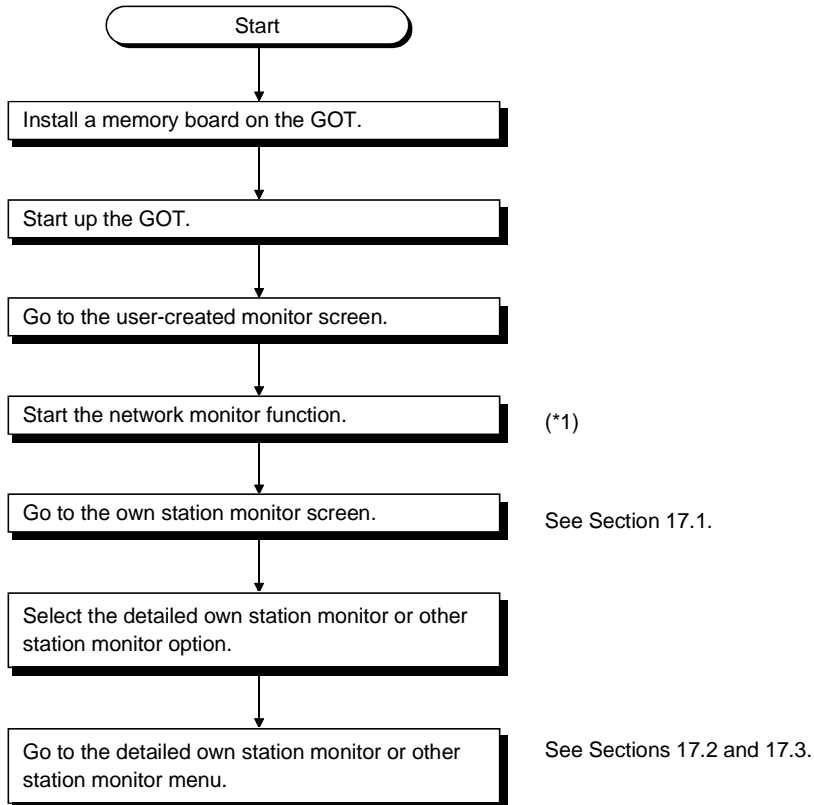

*1 Touch the key assigned to the network monitor function (set in the touch switch expanded function of the GT Designer). In the Utility Menu screen, touch **NET.MON.** to start the network monitor function.

CHAPTER16 SWITCHING THE NETWORK MONITOR SCREENS

The following flowchart outlines the steps involved in switching the network monitor screens.

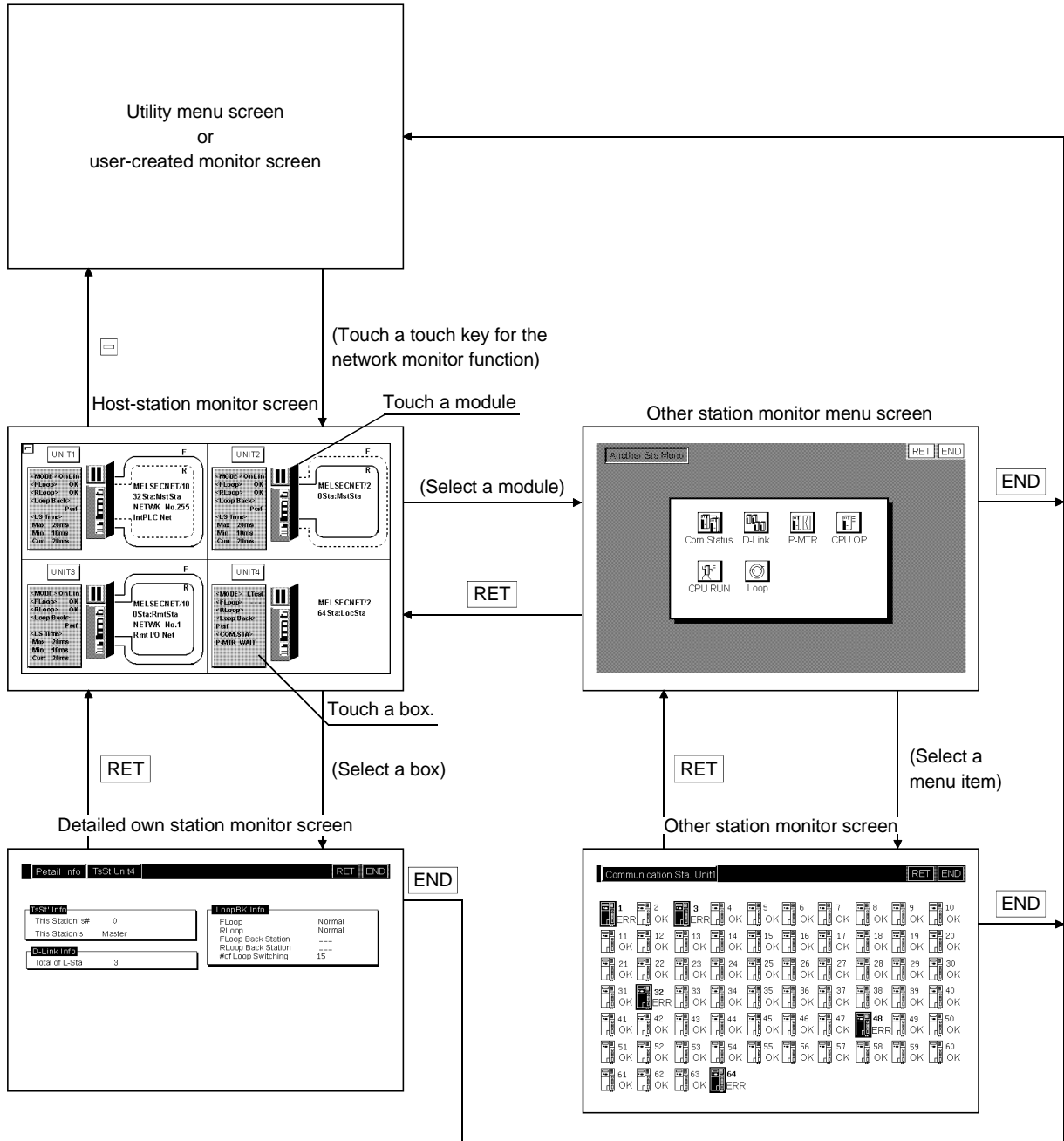

CHAPTER17 USING THE NETWORK MONITOR SCREENS

This chapter describes how to use various monitor screens when you execute the network monitor function.

17.1 Own station monitor

This section describes the structure of the monitor screen and the common operations used when executing the own station monitor.

17.1.1 Display contents and keys functions: own station monitor

This section describes the own station monitor screen and the function of on-screen keys, all of which are displayed and used when executing the network monitor function.

(1) Display contents



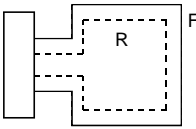
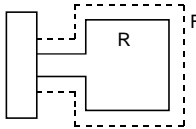
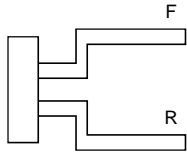
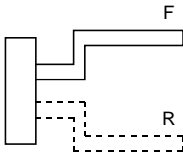
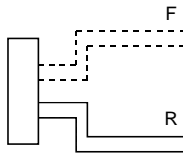
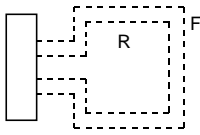

When the A985/97*/960GOT is used	When the A95*/956WGOT is used
	<p>The display details are the same as the ones on the A985/97*/960GOT.</p> <p>Touch button to change the display.</p> <p>(Display example)</p>

No.	Contents of Display
1)	<p>(1) This shows the action mode of the own station: On-line, Off-line, loop test.</p> <p>(2) This shows the status of the F-loop (primary loop): OK, NG.</p> <p>(3) This shows the status of the R-loop (secondary loop): OK, NG.</p> <p>(4) This shows whether the loopback was executed or not: Executed, Not executed.</p> <p>(5) This shows link scan time required for the control station and the ordinary station, for the remote master station and the remote I/O station, and for the mater station and all the sub-stations.</p> <p>(a) Maximum (the maximum value of link scan time)</p> <p>(b) Minimum (the minimum value of link scan time)</p> <p>(c) Current (the current value of link scan time)</p>
2)	<p>This shows the network category, network number, and station number.</p>
3)	<p>This shows the loop status of a network system as follows: (Primary loop: F, Secondary loop: R)</p> <p>(a) Primary loop : OK (b) Primary loop : OK (c) Primary loop : NG Secondary loop : OK Secondary loop : NG Secondary loop : OK</p> <p>(d) Executing loopback (e) Primary loop : NG (f) MELSECNET/10 (g) MELSECNET/10 loopback Secondary loop : NG coaxial bus (OK) coaxial bus (NG)</p>

No.	Contents of Display		
3)	The following loop status in the data link system is displayed. (Primary loop: F, Sub-loop: R)		
	(a) Data is linked in the Primary loop.	(b) Data is linked in the sub-loop.	(c) Loop-back is performed in the Primary/sub loop direction.
			
	(d) Loop-back is performed in the Primary loop direction only.	(e) Loop-back is performed in the sub-loop direction only.	(f) Data link is not available.
			

(2) Key functions

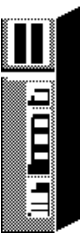
This section describes the function of keys to be used on the own station monitor screen.

Key	Function
	Exits the own station monitor screen and returns to the previous monitor screen where the network monitor function was executed.
	Switches to the detailed monitor screen that corresponds to the module displayed on the current monitor screen. This key is effective for each screen.
	Switches to the other station monitor menu that corresponds to the network displayed on the current monitor screen. This key is effective for each screen.
	Changes the details on the window. (only for A95*GOT)
	Changes the monitoring destination CPU using the CPU No. (For multi-PLC system connection only) The CPU No. is displayed according to the number of CPUs loaded.

17.2 Detailed own station monitor

This section describes the structure of the monitor screen and the common operations used when executing the detailed own station monitor.

17.2.1 Display contents and keys functions: acting as a MELSECNET/B or MELSECNET (II) master station

This section describes the detailed own station monitor screen and the function of on-screen keys, all of which are displayed and used when the own station acts as the master station on the MELSECNET/B or MELSECNET (II).

(1) Display contents

When the A985/97*/960GOT is used	When the A95*/956WGOT is used
	<p>The display details are the same as the ones on the A985/97*/960GOT.</p> <p>Touch button to change the display.</p> <p>(Display example)</p>

No.	Section	Contents of Display
1)	TsSt's Info	<ul style="list-style-type: none"> • This Station's # Indicates the station number of the own station. • This Station's: Indicates the category of the own station.
2)	D-Link Info	<ul style="list-style-type: none"> • Total of L-Sta: Indicates the maximum number of the stations to be linked. The maximum number is defined by common parameters.
3)	LoopBK Info	<ul style="list-style-type: none"> • FLoop: Shows the status of the primary loop lines of the own station. (Normal/NG) • RLoop: Shows the status of the secondary loop lines of the own station. (Normal/NG) • Floop Back Station: Indicates the station number of a station that executes the loopback along the primary loop. • Rloop Back Station: Indicates the station number of a station that executes the loopback along the secondary loop. • # of Loop Switching: Indicates the cumulative number of times for which loops have been switched.

(2) Key functions

The table below shows the function of keys that are used on the detailed own station monitor screen.

Key	Function
	Returns to the own station monitor screen.
	Exits the detailed own station monitor screen and returns to the previous monitor screen where the network monitor function was executed.
	Changes the details on the window. (only for A95*GOT)

17.2.2 Display contents and keys functions: acting as a MELSECNET/B or MELSECNET (II) local station

This section describes the detailed own station monitor screen and the function of on-screen keys, all of which are displayed and used when the own station acts as the local station on the MELSECNET/B or MELSECNET (II).

(1) Display contents

When the A985/97*/960GOT is used	When the A95*/956WGOT is used
	<p>The display details are the same as the ones on the A985/97*/960GOT.</p> <p>Touch button to change the display.</p> <p>(Display example)</p>

No.	Section	Contents of Display
1)	TsSt' Info	<ul style="list-style-type: none"> This Station's # Indicates the station number of the own station. This Station's: Indicates the category of the own station.
2)	D-Link Info	<ul style="list-style-type: none"> Total of L-Sta: Indicates the maximum number of the stations to be linked. The maximum number is defined by common parameters.
3)	Com Status	<ul style="list-style-type: none"> Com Status: Displays the communications status of the own station. (Parameter wait, Cyclic comm, NG)
4)	BWY From Master	<ul style="list-style-type: none"> This shows the status of receiving Device BWY from the master station. OK: Data is being received by cyclic receiving. NG: The own station cannot receive data because of column reading.
5)	BW From Hostmaster	<ul style="list-style-type: none"> This shows the status of receiving Device BW from the master station of a dual-layer system. OK: Data is being received by cyclic receiving. NG: The own station cannot receive data due to column reading.
6)	LoopBK Info	<ul style="list-style-type: none"> FLoop: Shows the status of the primary loop lines of the own station. (Normal/NG) RLoop: Shows the status of the secondary loop lines of the own station. (Normal/NG)

(2) Key functions

The table below shows the functions of keys that are used on the detailed own station monitor screen.

Key	Function
	Returns to the own station monitor screen.
	Exits the detailed own station monitor screen and returns to the previous monitor screen where the network monitor function was executed.
	Changes the details on the window. (only for A95*GOT)

17.2.3 Display contents and keys functions: acting as a MELSECNET/10 Control station/ordinary Station

This section describes the contents of the detailed own station monitor screen and the function of on-screen keys. All these are displayed and used when the own station acts as the control station/ordinary station on the MELSECNET/10.

(1) Display contents

When the A985/97*/960GOT is used	When the A95*/956WGOT is used
	<p>The display details are the same as the ones on the A985/97*/960GOT. Touch button to change the display. (Display example)</p>

No.	Section	Contents of Display
1)	TsSt' Info	<ul style="list-style-type: none"> • This Station's # : Indicates the station number of the own station. • Network # : Indicates the network number. • Group # : Indicates the group number.
2)	Ctrl St Info	<ul style="list-style-type: none"> • Spc Ctrl Sta: Indicates the station number of a station that is specified as a control station. • Curr Ctrl Sta: Indicates the station number of a station that is currently acting as the control station. • Com Info: Indicates whether the own station is communicating with the control station or the sub control station. • SubCtrl Sta Com: Indicates the availability of a sub control station. (Available/None) • Rmt I/O Mst Sta: *1 Indicates the station number of a remote I/O master station in Block 1 or Block 2. If the master station is not available, this indicates "None" instead.

*1 Not displayed when the CPU type of the GOT connection target is the AnNCPUs or AnACPU.



No.	Section	Contents of Display
3)	D-Link Info	<ul style="list-style-type: none"> • Total of L-Sta: Indicates the maximum number of the stations to be linked. The maximum number is defined by common parameters. • Largest Nrm Sta: Indicates the station number of the largest station that is connected in a normal condition. • Largest DL-Sta: Indicates the station number of the largest station that is data-linked. • Com Status: Show the current communications status of the own station. (D- Link in prog, D- Link Stop (A), D- Link Stop (H), B- Pass excut, Disconnection, Testing, Reset. in prgr.) • Causes of Ssp: Indicates the causes why the communications were interrupted. This indicates "OK" if communications is in a normal condition. (Normal, Offline, Offline Test, Others (error codes)) • Causes of Stop: Indicates the causes why the data link was stopped. This indicate "OK" if the data link is in a normal condition. (No common para, Host Para error, Instructed by Other Station (n station), Essential Parameter Not Matched, Instructed by Host Station, Improper I/O Allocation, Instructed by All Stations (n stations), Others (error codes))
4)	Constant LS	<ul style="list-style-type: none"> • Constant LS: Indicates the predetermined time of constant link scans.
5)	LoopBK Info	<ul style="list-style-type: none"> • FLoop: Shows the status of the primary loop lines of the own station. (Normal/LoopBK Trans/D-Link Impo) • RLoop: Shows the status of the secondary loop lines of the own station. (Normal/LoopBK Trans/D-Link Impo) • FLoop Back Station: Indicates the station number of a station that executes the loopback along the primary loop. • RLoop Back Station: Indicates the station number of a station that executes the loopback along the secondary loop. • # of Loop Switching: Indicates the cumulative number of times for which loops have been switched. * "---" is displayed when coaxial bus connections are established.

No.	Section	Contents of Display
6)	TsSt' Sta	<ul style="list-style-type: none"> • Parameter Setting: Common Param, Common + Spec if, Default Param, Default + Specif • Reserved Sta: Indicates the availability of a reserved station. (Have/None) • Communication Mode: Indicates either of "Normal mode" or "Constant LS." • Transmission Mode: Indicates either of "Normal Trans" or "Multipl Trans." * • Transmission Stat: Indicates either of "Normal Trans" or "Multipl Trans." *

* "---" is displayed when coaxial bus connections are established.

(2) Key functions

The table below shows the function of keys that are used on the detailed own station monitor screen.

Key	Function
	Returns to the own station monitor screen.
	Exits the detailed own station monitor screen and returns to the previous monitor screen where the network monitor function was executed.
	Changes the details on the window. (only for A95*GOT)

17.2.4 Display contents and keys functions: acting as a MELSECNET/10 remote master station

This section describes the detailed own station monitor screen and the function of on-screen keys, all of which are displayed and used when the own station acts as the remote master station on the MELSECNET/10.

(1) Display contents

When the A985/97*/960GOT is used	When the A95*/956WGOT is used
	<p>The display details are the same as the ones on the A985/97*/960GOT.</p> <p>Touch button to change the display.</p> <p>(Display example)</p>

No.	Section	Contents of Display
1)	TsSt' Info	<ul style="list-style-type: none"> • This Stations # : Indicates the station number of the own station. • Network # : Indicates the network number. • Group # : Not displayed.
2)	Ctrl St Info	<ul style="list-style-type: none"> • Spc Ctrl Sta: Not displayed • Curr Ctrl Sta: Not displayed • Com Info: Not displayed • SubCtrl-Sta Com: Not displayed



No.	Section	Contents of Display
3)	D-Link Info	<ul style="list-style-type: none"> • Total of L-Sta: Indicates the maximum number of the stations to be linked. The maximum number is defined by common parameters. • Largest Nrm Sta: Indicates the station number of the largest station that is connected in a normal condition. • Largest DL-Sta: Indicates the station number of the largest station that is data-linked. • Com Status: Show the current communications status of the own station. (D-Link in prog, D-Link Stop (A), D-Link Stop (H), B-Pass excut, Disconnection, Testing, Reset. in prgr.) • Causes of Ssp: Indicates the reason why the communications were interrupted. This indicates "OK" if communications is in a normal condition. (Normal, Offline, Offline Test, Others (error codes)) • Causes of Stop: Indicates the causes why the data link was stopped. This indicates "OK" if the data link is in a normal condition. (No common para, Host Para error, Instructed by Other Station (n station), Essential Parameter Not Matched, Instructed by Host Station, Improper I/O Allocation, Instructed by All Stations (n stations), Others (error codes))
4)	Constant LS	<ul style="list-style-type: none"> • Constant LS: Indicates the predetermined time of constant link scans.
5)	LoopBK Info	<ul style="list-style-type: none"> • FLoop: Shows the status of the primary loop lines of the own station. (Normal/LoopBK Trans/D-Link Impo) • RLoop: Shows the status of the secondary loop lines of the own station. (Normal/LoopBK Trans/D-Link Impo) • FLoop Back Station: Indicates the station number of a station that executes the loopback along the primary loop. • RLoop Back Station: Indicates the station number of a station that executes the loopback along the secondary loop. • # of Loop Switching: Indicates the cumulative number of times for which loops have been switched. * "---" is displayed when coaxial bus connections are established.

No.	Section	Contents of Display
6)	TsSt' Sta	<ul style="list-style-type: none"> • Parameter Setting: Not displayed. • Reserved Sta: Indicates the availability of a reserved station. (Have/None) • Communication Mode: Indicates either of "Normal mode" or "Constant LS." • Transmission Mode: Indicates either of " Normal Trans " or " Multipl trans." * • Transmission Stat: Indicates either of " Normal Trans " or Multipl trans." *

* "---" is displayed when coaxial bus connections are established.

(2) Key functions

The table below shows the function of keys that are used on the detailed own station monitor screen.

Key	Function
	Returns to the own station monitor screen.
	Exits the detailed own station monitor screen and returns to the previous monitor screen where the network monitor function was executed.
	Changes the details on the window. (only for A95*GOT)

17.3 Other station monitor

This section describes the structure of the monitor screen and the common operations used when executing the other station monitor.

17.3.1 Display contents and keys functions: other station monitor menu

This section describes the other station monitor menu screen and the function of on-screen keys. The menu screen for the other station monitor is displayed by touching a module number displayed on the own station monitor screen. The menu screen provides many options for the other station monitor.

(1) Display contents

When the A985/97*/960GOT is used	When the A95*/956WGOT is used
	<p>The display details are the same as the ones on the A985/97*/960GOT.</p> <p>(Display example)</p>

No.	Touch Key	Contents of Display
1)	Communications Status	Switches to a monitor screen that shows the communications status of other stations. *
2)	Data Link	Switches to a monitor screen that shows the data link status of other stations. *
3)	Parameters	Switches to a monitor screen that shows the parameter status of other stations. *
4)	CPU Action	Switches to a monitor screen that shows the CPU action status of other stations.
5)	CPU RUN	Switches to a monitor screen that shows the CPU RUN status of other stations.
6)	Loop	Switches to a monitor screen that shows the loop status of other stations.

* This is not selectable when connected to a MELSECNET/B or MELSECNET (II) local station.

(2) Key Functions

The table below shows the function of keys that are used on the other station monitor screen.

Key	Function
	Switches to the other station monitor screen.
	Returns to the own station monitor screen.
	Exits the other station monitor screen and returns to the previous monitor screen where the network monitor function was executed.

17.3.2 Display contents and keys functions: other station communication status monitor

This section describes the other station communications status monitor screen and the function of on-screen keys.

(1) Display contents

When the A985/97*/960GOT is used	When the A95*/956WGOT is used
	<p>The display details are the same as the ones on the A985/97*/960GOT.</p> <p>(Display example)</p>

No.	Contents of Display
1)	Station numbers are shown up to the maximum number of linked stations.
2)	Any station in an abnormal condition is highlighted on-screen.
3)	Any station specified as a reserved station is treated as a station that stays in a normal condition.

(2) Key Functions

The table below shows the function of keys that are used on the other station communications status monitor screen.

Key	Function
RET	Returns to the own station monitor screen.
END	Exits the other station communications status monitor screen and returns to the previous monitor screen where the network monitor function was executed.

17.3.3 Display contents and keys functions: other station data link status monitor

This section describes the other station data link status monitor screen and the function of on-screen keys.

(1) Display contents

When the A985/97*/960GOT is used	When the A95*/956WGOT is used
	<p>The display details are the same as the ones on the A985/97*/960GOT.</p> <p>(Display example)</p>

No.	Contents of Display
1)	Station numbers are shown up to the maximum number of linked stations.
2)	Any station that is not data-linked is highlighted on-screen.
3)	Any station specified as a reserved station is treated as a station that stays in a normal condition.

(2) Key Functions

The table below shows the function of keys that are used on the other station data link status monitor screen.

Key	Function
RET	Returns to the own station monitor screen.
END	Exits the other station data link status monitor screen and returns to the previous monitor screen where the network monitor function was executed.

17.3.4 Display contents and keys functions: other station parameter status monitor

This section describes the other station parameter status monitor screen and the function of on-screen keys.

(1) Display contents

When the A985/97*/960GOT is used	When the A95*/956WGOT is used
	<p>The display details are the same as the ones on the A985/97*/960GOT.</p> <p>(Display example)</p>

No.	Contents of Display
1)	Station numbers are shown up to the maximum number of linked stations.
2)	Any station whose parameters are monitored is highlighted on-screen. *
3)	Any station that stays in an abnormal condition is highlighted on-screen.
4)	A station specified as a reserved station is treated as a station that stays in a normal condition.

* Not highlighted when connected to a MELSECNET/B or MELSECNET (II) master station.

(2) Key Functions

The table below shows the function of keys that are used on the other station parameter status monitor screen.

Key	Function
RET	Returns to the own station monitor screen.
END	Exits the other station parameter status monitor screen and returns to the previous monitor screen where the network monitor function was executed.

17.3.5 Display contents and keys functions: other station CPU action status monitor

This section describes the other station CPU action status monitor screen and the function of on-screen keys.

This option is not selectable when connecting to a remote I/O network system.

(1) Display contents

When the A985/97*/960GOT is used	When the A95*/956WGOT is used
	<p>The display details are the same as the ones on the A985/97*/960GOT.</p> <p>(Display example)</p>

No.	Contents of Display
1)	Station numbers are shown up to the maximum number of linked stations.
2)	Any station that stays in an abnormal condition or out of action is highlighted on-screen.
3)	A station specified as a reserved station is treated as a station that stays in a normal condition.

(2) Key Functions

The table below shows the function of keys that are used on the other station CPU action status monitor screen.

Key	Function
RET	Returns to the own station monitor screen.
END	Exits the other station CPU action status monitor screen and returns to the previous monitor screen where the network monitor function was executed.

17.3.6 Display contents and keys functions: other station CPU RUN status monitor

This section describes the other station CPU RUN status monitor screen and the function of on-screen keys.

This option is not selectable when connecting to a remote I/O network system.

(1) Display contents

When the A985/97*/960GOT is used	When the A95*/956WGOT is used
	<p>The display details are the same as the ones on the A985/97*/960GOT.</p> <p>(Display example)</p>

No.	Contents of Display
1)	Up to 64 station numbers are shown.
2)	"---" is displayed below station numbers of reserved stations or any stations that come after the maximum number of linked stations.

(2) Key Functions

The table below shows the function of keys that are used on the other station CPU RUN status monitor screen.

Key	Function
RET	Returns to the own station monitor screen.
END	Exits the other station CPU RUN status monitor screen and returns to the previous monitor screen where the network monitor function was executed.

17.3.7 Display contents and keys functions: other station loop status monitor

This section describes the other station loop status monitor screen and the function of on-screen keys.

* This option is not selectable when connecting to a MELSECNET/B or MELSECNET (II) local station or establishing MELSECNET/10 coaxial bus connections.

(1) Display contents

When the A985/97*/960GOT is used	When the A95*/956WGOT is used
	<p>The display details are the same as the ones on the A985/97*/960GOT.</p> <p>(Display example)</p>

No.	Contents of Display
1)	The F-loop (primary loop) status and the R-loop (secondary loop status) are displayed.
2)	Station numbers are shown up to the maximum number of linked stations.
3)	Any station that stays in an abnormal condition is highlighted on-screen.
4)	A station specified as a reserved station is treated as a station that stays in a normal condition.

(2) Key Functions

The table below shows the function of keys that are used on the other station loop status monitor screen.

Key	Function
RET	Returns to the own station monitor screen.
END	Exits the other station loop status monitor screen and returns to the previous monitor screen where the network monitor function was executed.

CHAPTER18 ERROR DISPLAYS AND COUNTERMEASURES WHEN MONITORING NETWORKS

The following chart shows the error messages that are displayed during the network monitor operation and how to handle them.

Error message	Contents of error	Action to take
Can not Communication	Communication could not established with the PLC CPU.	<ul style="list-style-type: none"> • Check the connections between the PLC CPU and the GOT for disconnected connectors and cables. • Check if an error has occurred in the PLC CPU.
Key Word error	The PLC CPU to be connected is keyword-protected by the QnA.	<ul style="list-style-type: none"> • Release the keyword.

CHAPTER19 OPERATION PROCEDURES FOR THE LIST EDITOR FUNCTION

This section describes the operation procedures for use of list editor function.

19.1 Operation procedures before starting the list edit

Procedures for transferring the operating system (OS) for the list editor function from the personal computer to the GOT and for installing the system into the memory. For details, refer to the Help of the drawing software. Detailed information including displays and key operations is provided.

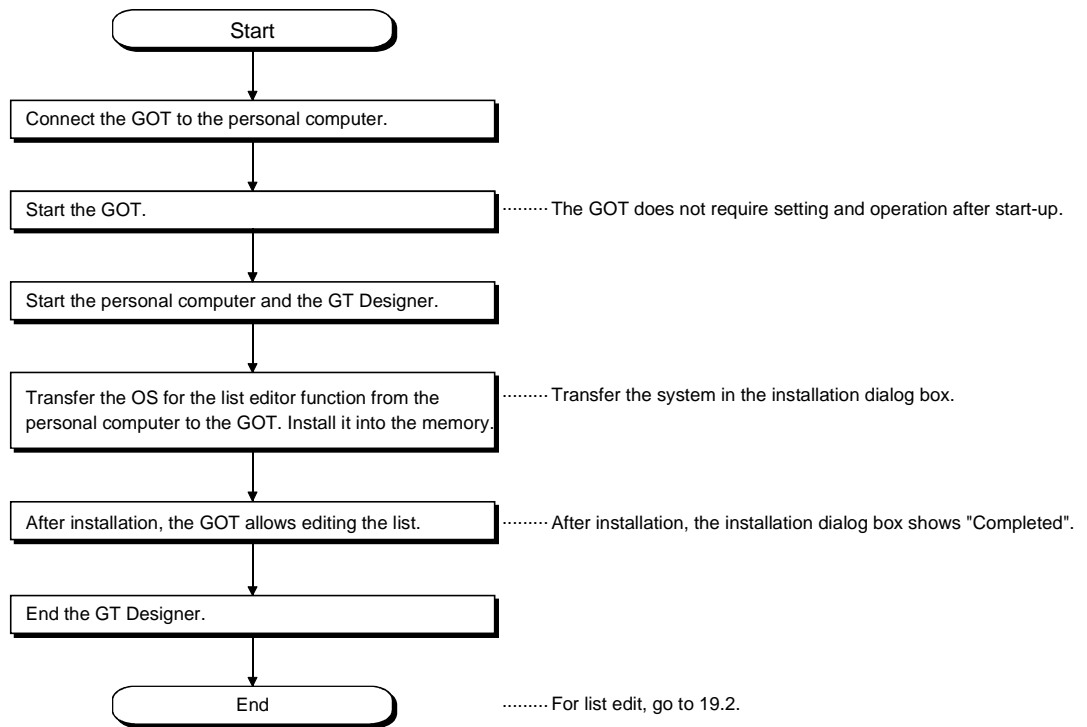

19.2 Operation procedures from user-created monitor screen display to starting list editing

This section explains how you should operate the GOT to access the list editor function after having installed the list editor function operating system (OS) to the GOT internal memory.

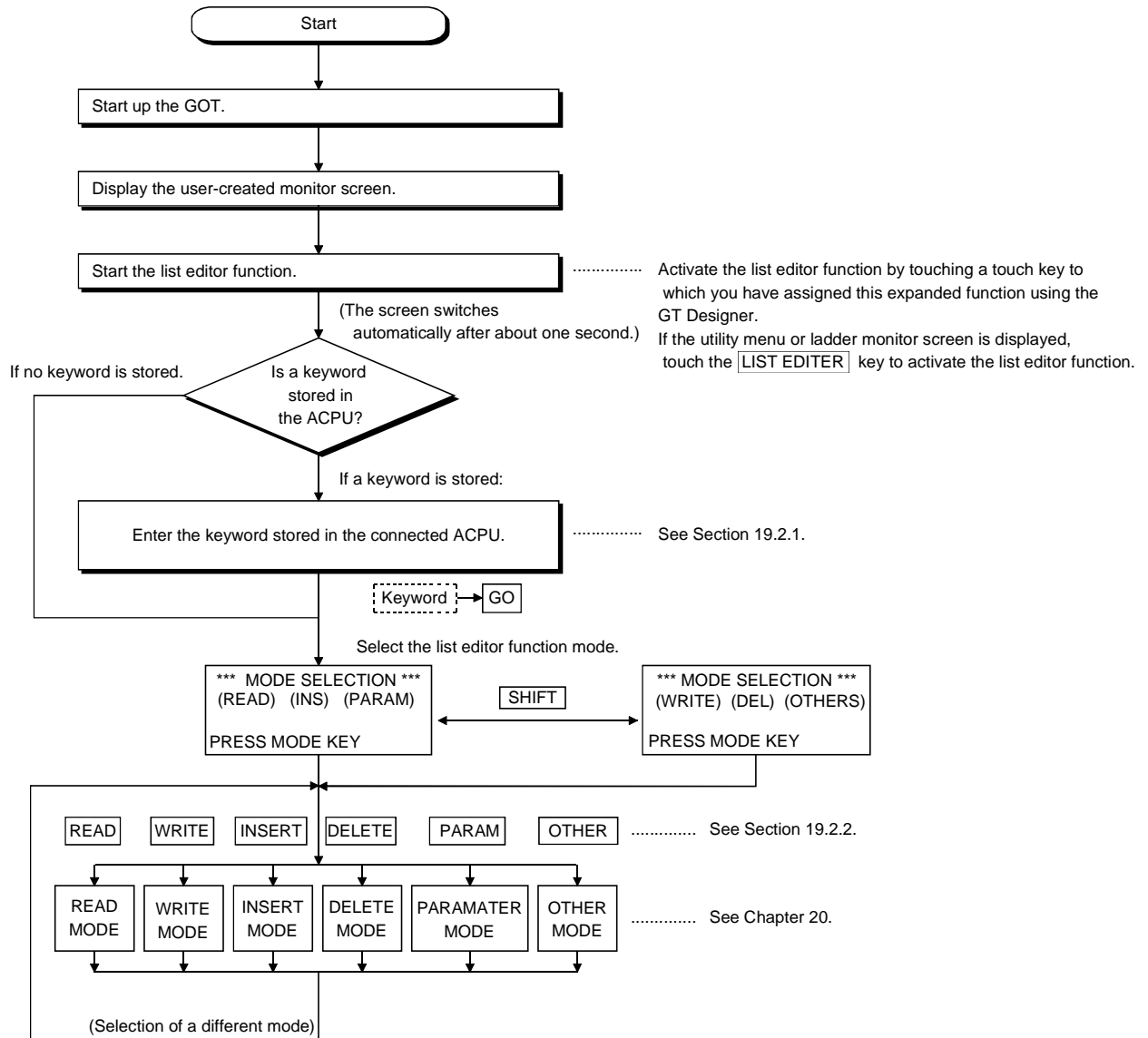

19.2.1 Operation of keyword input

If a keyword is registered in the ACPU when the connected ACPU or the ACPU PLC No. corresponding to the operation is changed, the GOT requests for input of the registered keyword. Input the keyword registered in the ACPU and press the **GO** key. If a keyword is not registered in the ACPU, this operation is not required. (The operation automatically changes to Selection of Function and Mode in 19.2.2.)

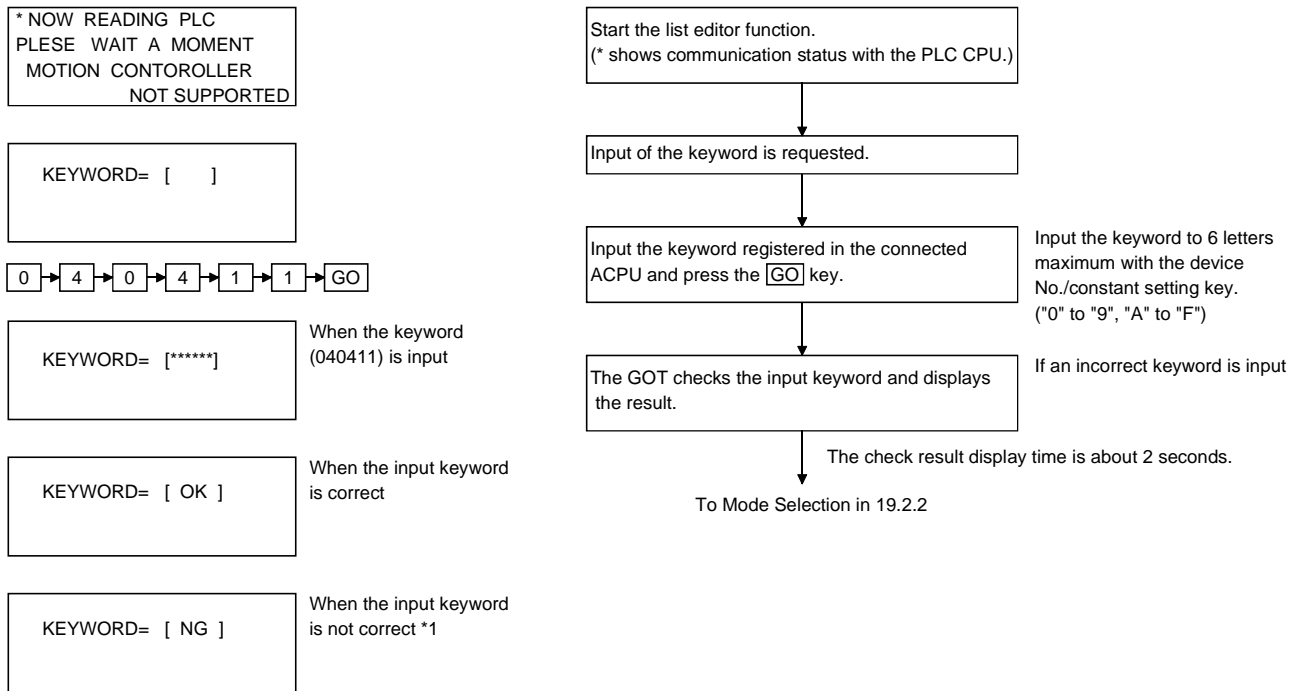

*1 When the input keyword does not match with the registered keyword, only the following operations in Chapter 20 can be allowed.

- Other modes
- Error step reading
 - Buffer memory overall monitor
 - Time monitor
 - PLC No. setting
 - Main/sub switching

POINTS
<ul style="list-style-type: none"> • For operations not shown in other modes, clear (delete) the registered keyword with the "PLC memory all clear" in the following page if you do not remember the keyword registered in the ACPU. When "PLC memory all clear" is performed, the user data including sequence program is also cleared. • The keyword registered in the ACPU can be changed or a new keyword can be registered as shown in Chapter 20.

When input of a keyword is requested, all parameters and sequence programs can be cleared together with the keyword registered in the ACPU using the operation below.

(Step 1) Display the keyword input request.

KEYWORD= []

(Step 2) Stop operation of ACPU

(Step 3) Operation of PC memory all clear

Input "ALLCLR" and press the GO key.

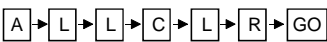

(Step 4) Display of PC memory all clear process

When the GOT starts clearing the process, the display in the left appears. "***" column and the total number of bytes change sequentially.

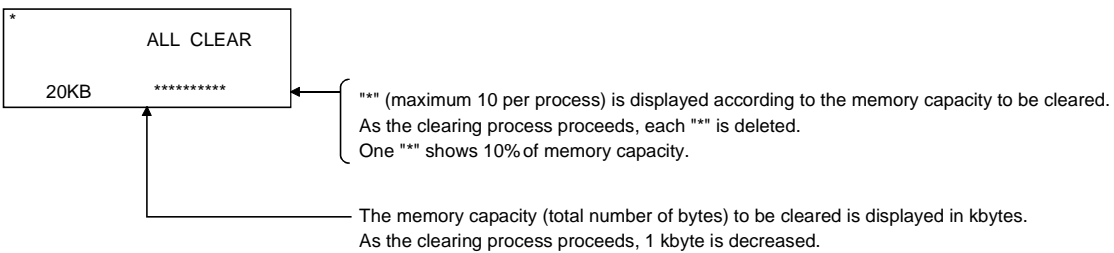

(Step 5) Completion of PC memory all clear process

When the GOT completes the clearing process, the screen in the left appears.
(status before the mode selection)

** MODE SELECTION **
(READ) (INS) (PARAM)

PRESS MODE KEY

(Step 6) Select the mode as in 19.2.2 and start the following operation.

19.2.2 Selection and operation of mode

After the keyword input, select the mode in the list editor function for operations in Chapter 20.

(1) Selection and change of mode with mode key

Select the mode with the mode key (Refer to 3.5.5.) so that operation corresponding to the mode in Chapter 20 may be performed.

The mode can be freely changed when operations in Chapter 20 are performed. Various operations can be continued while changing modes. *1

READ	-----	Read mode
WRITE	-----	Write mode
INSERT	-----	Insert mode
DELETE	-----	Delete mode
PARAM	-----	Parameter mode
OTHER	-----	Other mode

*1 Mode key input is always valid.

Input of the mode key clears the input data except for the step numbers. The display returns to the initial status of the mode selection.

(2) Operation in each mode

The mode selected in (1) allows for operation corresponding to the mode in Chapter 20. Operation procedures of each mode are described in Chapter 20. Operate the GOT according to the description.

If an error message appears during operation, take action according to Chapter 21.

CHAPTER20 OPERATION OF EDITING SCREEN FOR EACH LIST

This section describes the operation procedures of the list edit screen.

20.1 Basic operation of key input

After starting the list editor function, basic operations of key input are described.

20.1.1 Switching of valid key (function indicated at the upper/lower part of the key)

When the list edit has started, whether the upper or the lower key available for two purposes is valid is displayed on the second line at the left end of the display.

The GOT controls and displays the valid key. A user may switch the valid key with the following keys.

* :Upper character key is valid.

:Lower character key is valid.

* The following keys can be input if the valid key is at the lower character.

(Input of key is not required.)

- Comparison symbol key at the command input of comparison operation instruction.

, ,

- Minus key at the source data of command.

The valid key after setting each mode switches as follows:

Read mode, Write mode, Insert mode : Upper character key
(When the cursor position is at the setting value and the device step is in the Write mode, the "lower character" key is valid.)

Parameter mode and other modes : Always lower character key

Help of each mode : Always lower character key
(When "Command Read" is selected from the Help in the Read mode, the upper character key is valid.)

When key is input and the valid key is switched, the switched side is valid until the mode key and the control key are input.

For details of each key, refer to 3.5.4.

20.1.2 Command input procedures

Command input procedures can be classified as follows:

- 1) Input the command key to use the command on the key.
- 2) Input the alphanumeric keys corresponding to each character of command sequentially.
- 3) Select and input the command to be used from the Help function.

Command input procedures for 1) and 2) above are as follows.

For command input procedure 3) from the Help function, refer to 20.2.5.

POINT	<p>When the command is input, the input details are displayed at the 4th line (the bottom line) on the display. In the following description, the input of SP key may be omitted when a blank space between the input command and the cursor position is automatically inserted. Refer to the example in each description.</p>
--------------	--

(1) For command code only

- 1) When the command available on the keyboard is input

Command → GO

(Ex) When END is input

W	1	1	2	0	U	T	T	0
▲	1	1	2		K	1	2	3
	1	1	3		▶	N	O	P
	1	1	4		N	O	P	

END → GO

W	1	1	2	K	1	2	3	
▲	1	1	3		E	N	D	
	1	1	4		▶	N	O	P
	1	1	5		N	O	P	

- 2) When the command not available on the keyboard is input

(Ex) When FOR K5 is input

W	5	0	0	U	T	Y	0	0	2	2
▲	5	1		▶	N	O	P			
	5	2		N	O	P				
	5	3		N	O	P				

SET → F → 0 → R → SP → K → 5 → GO

W	5	1	F	O	R		
▲	5	1		K	5		
	5	4		▶	N	O	P
	5	5		N	O	P	

(2) For command code and device (1)

Command → → DEVICE → DEVICE No. →

(Ex) When LD X0 is input

W	1 1 2	0 U T	T 0
▲	1 1 2	K 1 2 3	
	1 1 3	▶ N 0 P	
	1 1 4	N 0 P	

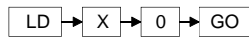

W	1 1 2	K 1 2 3	
▲	1 1 3	L D	X 0 0 0 0
	1 1 4	▶ N 0 P	
	1 1 5	N 0 P	

(3) For commands other than above

Input the key between the command and the device, the source data, and the destination data.

(Ex 1) When FMOV K-2 DO K5 is input

W	1 1 5	M 5	
▲	1 2 0	L D	M 3
	1 2 1	▶ N 0 P	
	1 2 2	N 0 P	

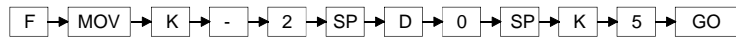

W	1 2 1	D 0	
▲	1 2 1	K 5	
	1 3 0	▶ N 0 P	
	1 3 1	N 0 P	

(Ex 2) When OUT T1 K10 is input

W	1 1 2	K 1 2 3	
▲	1 1 3	L D	X 0 0 0 0
	1 1 4	▶ N 0 P	
	1 1 5	N 0 P	

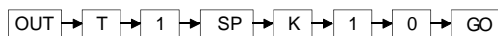

W	1 1 4	0 U T	T 1
▲	1 1 4	K 1 0	
	1 1 5	▶ N 0 P	
	1 1 6	N 0 P	

(Ex 3) When MC N3 M5 is input

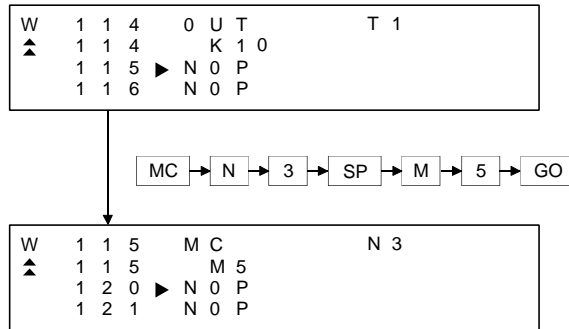

(Ex 4) When LD = K10 D10 is input

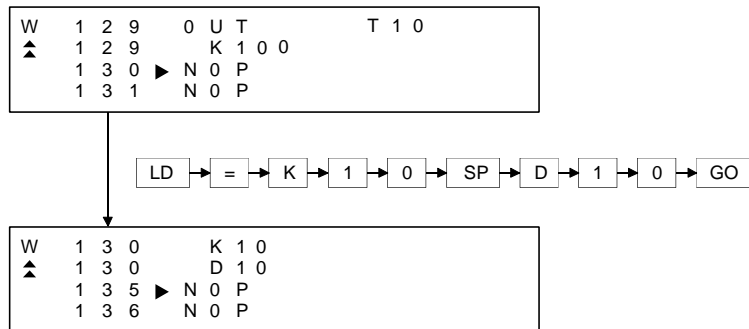

(Ex 5) When ANDD<=H7FFFF D20 is input

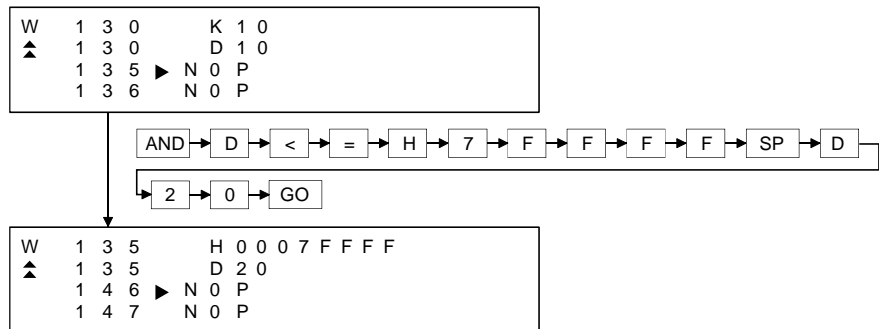

(4) Handling of devices M, L and S

Devices M, L and S in the Test, Monitor, Write and Insert modes change the display depending on the set parameters.

If LD L0 is input for the parameter setting of M0 to 999 and L1000 to L2047, the result is LD M0.

(5) For extension timer/extension counter of AnA and AnUCPU

When the extension timer (T256 to T2047) and the extension counter (C256 to C1023) are input as the first device of the command, input the first device and the device number.

(Ex) When OUT T256 D500 is input

W	9 9	0 U T	M 1 0
▲	1 0 0	L D	
	1 0 1	▶ N O P	
	1 0 2	N O P	

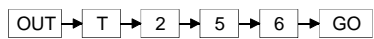

W	1 0 1	0 U T	T 2 5 6
▲	1 0 2	D 5 0 0	
	1 0 3	▶ N O P	
	1 0 4	N O P	

← The device (D500) for the T256 setting value on the parameter is automatically displayed.

POINT
<p>When the extension timer and the extension counter are used, be sure to set the 257 points or more and the setting value device (D, W, R) on the parameter for both the timer and the counter.</p>

20.1.3 Action if an incorrect key is input

- (1) Input the **CLEAR** key before the **GO** key. Then input the correct key.
Input of the **CLEAR** key clears the command and the device number that have been input immediately. The display returns to the status (status before change in the Write mode) when the mode is selected.
- (2) When the **GO** key is input, repeat the intended operation.
Command input procedures can be classified as follows:

REMARK

When the **CLEAR** key is input in the parameter mode, the GOT stops the process. To continue the operation, carry on the key input.

20.2 Basic operation of list edit

This section describes basic operations of list edit with simple operation examples.

20.2.1 Reading sequence program

The sequence program is read to check its content.

[Operation example]

1) <input type="button" value="READ"/>	<pre>R 7 D20 ^ 14 END 15▶NCP 16 NCP</pre>	Select the "Read" mode.
2) <input type="button" value="SET"/> → <input type="button" value="0"/> → <input type="button" value="GO"/>	<pre>R 0▶LD X0000 ^ 1 CR Y0010 2 ANI X0001 3 OUT Y0010</pre>	Read the 0th step.
3) <input type="button" value="GO"/>	<pre>R 3 OUT Y0010 ^ 4▶OUT T0 4 K10 5 LD T0</pre>	
↓		
Scroll the screen with the <input type="button" value="GO"/> key.		

20.2.2 Changing (overwriting) command

The following example shows the changing procedure of the sequence program.

<p>Before change</p> <pre> } 3 OUT Y010 4 OUT T0 [K10] } </pre>		<p>Change the timer setting value from K10 to K100.</p>
<p>After change</p> <pre> } 3 OUT Y010 4 OUT T0 [K100] } </pre>	<p>Change the timer setting value from K10 to K100.</p>	

[Operation example]

<p>1) SHIFT → WRITE</p>	<pre> W 7 K80 ^ 7▶ K5 7 D20 14 END </pre>	<p>Select the "Write" mode.</p>
<p>2) SET → 4 → GO</p>	<pre> W 3 OUT Y0010 ^ 4▶ OUT T0 4 K10 5 LD T0 </pre>	<p>Read the 4th step that changes the setting value.</p>
<p>3) ↓ → GO</p>	<pre> W 3 OUT Y0010 v 4 OUT T0 4▶ K10 K10 </pre>	<p>Move the cursor to setting value "K10" of T0.</p>
<p>4) K → 1 → 0 → 0 → GO</p>	<pre> W 4 OUT T0 ^ 4 K100 5▶ LD T0 6 ANI M0 </pre>	
<p>↓</p>		
<p>The setting value of timer T0 was changed from "K10" to "K100".</p>		

20.2.3 Adding (inserting) command

The following example shows the procedure of adding the command to the sequence program.

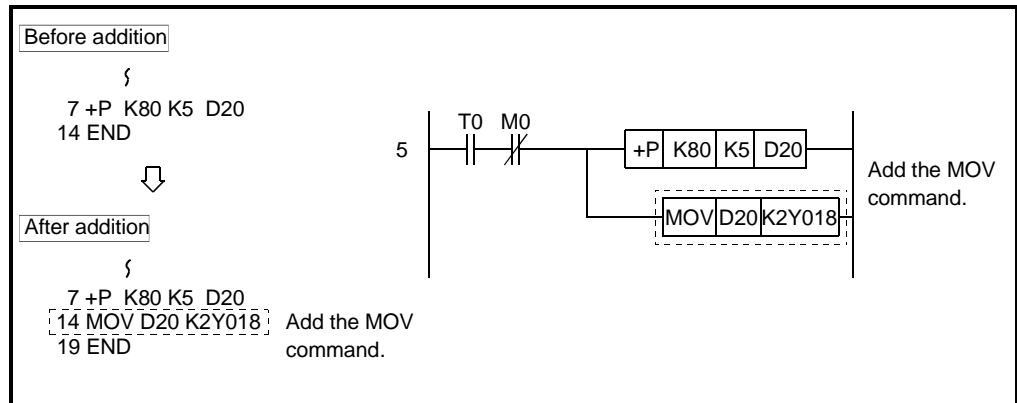

[Operation example]

1) INSERT	<pre> I 4 OUT T0 ^ 4 K100 5 LD T0 6 ANI M0 </pre>	Select the "Insert" mode.
2) SET → 1 → 4 → GO	<pre> I 7 D20 ^ 14 END 15 NOP 16 NOP </pre>	Read the 14th step to insert the command.
3) MOV → D → 2 → 0 → SP → K → 2 → Y → 1 → 8 → GO	<pre> I 14 D20 ^ 14 K2Y0018 19 END 20 NOP </pre>	

↓

The command of "MOV D20 K2Y0018" was added to Step 14.

20.2.4 Deleting command

The following example shows the procedure of deleting the command from the sequence program.

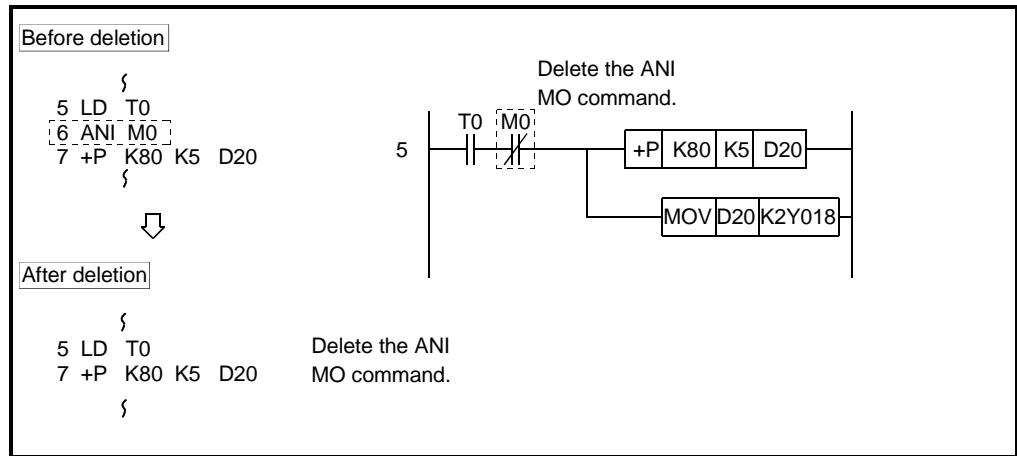

[Operation example]

1) SHIFT → DELETE	<pre>D 14 D20 ^ 14 K2Y0018 19▶END 20 NOP</pre>	Select the "Delete" mode.
2) SET → 6 → GO	<pre>D 5 LD T0 ^ 6▶ANI MD 7 +P 7 K80</pre>	Read the 6th step
3) GO	<pre>D 5 LD T0 ^ 6▶+P 6 K80 6 K5</pre>	The GO key deletes the command at the cursor position. The step number is brought forward.

↓

The "ANI MO" command was deleted.

20.2.5 Using Help function

HELP is input to use the Help function.

Input of **HELP** displays the Help function menus in each mode. Select the corresponding item for execution.

(1) Reading the command in the sequence program

Example of reading the area using the "MOV" command in the sequence program.

[Operation example]

1) READ → HELP	<pre>***HELP MENU*** 1: READ 2: COMMENT DISPLAY CLEAR:END</pre>	Input the HELP key in the Read mode.
2) 1	<pre>*** READ *** 1/2 1: STEP 2: INSTRUCTION CLEAR:END HELP:MENU</pre>	Select "Read".
3) 2	<pre>*** READ *** KEY IN STEP NO. [] CLEAR:END HELP:MENU</pre>	2: Select "Command".
4) MOV	<pre>*** READ *** KEY IN STEP NO. [MOV] CLEAR:END HELP:MENU</pre>	Set the "MOV" command.
5) GO	<pre>R 6 D20 ^ 13▶MOV 13 D20 13 K2Y0018</pre>	Reading "MOV D20 K2Y0018" of the 13th step.
6) GO	<pre>R 6 D20 ^ 13▶MOV 13 D20 NOT FOUND</pre>	Message when the "MOV" command is not present after the 13th step.

↓

Now, reading the command with the Help function command specification is completed.

(2) Displaying Kana comment

The following example shows the procedure of displaying the Kana comment in the Read mode.

[Operation example]

1) <input type="text" value="HELP"/>	<pre>***HELP MENU*** 1: READ 2: COMMENT DISPLAY CLEAR:END</pre>	Input the <input type="text" value="HELP"/> key in the Read mode.
2) <input type="text" value="2"/>	<pre>***COMMENT DISP.*** 1: YES 2: NO CLEAR:END HELP:MENU</pre>	2: Select the Kana comment display.
3) <input type="text" value="1"/>	<pre>R 0▶LD X0000 ▲ 1 OUT Y0020 2 LD X0000 Motor start limit</pre>	Select "1: Kana comment display". Display the Kana comment of the device at the cursor position.
4) <input type="text" value="↓"/>	<pre>R 0 LD X0000 ▲ 1▶OUT Y0020 2 LD X0000 Motor start check</pre>	

20.3 Operation procedure list of list edit

20.3.1 Common operation

	Details	Purpose	Procedures (key input sequence)
Basic operation	Input of keyword at start-up	Input when the keyword is registered in the ACPU.	Keyword → GO
	Mode selection	Select the mode.	Mode key (READ , INSERT , PARAM) SHIFT → Mode key (WRITE , DELETE , OTHERS)
	Switching of valid key	Switch the valid key (function indicated at the upper/lower part of the key) by a user.	SHIFT or SET
	Action for incorrect input	Perform the operation for incorrect key input.	CLEAR , Mode key or SHIFT → Mode key
	Operation of command help function	Perform operation with the Help function command specification.	Perform program display → HELP → 1 → 1 → 1 → Input the capital letter of the command.
	Display of Comment	Display the comment stored in the ACPU.	Perform program display operation → HELP → 2 → 1
Command input operation	Command code only	Input the command code only.	Command → GO
	Command code and 1 device	Input the command code and 1 device.	Command → SP → Device → Device No. → GO
	Other than above command key input)	Input the command other than above with the command key.	Input the SP between the device, the source data and the destination.
	Other than above (device key input)	Input the command other than above without the command key.	Input the SP between the command, the device, the source data and the destination.

20.3.2 Operation in Write mode (W)

	Details	Purpose	Procedures (key input sequence)
Continuous write in NOP		Set the specified range in the program to NOP.	Program display → HELP → 1 → 2
Write/modify (change) of program		Write the new program/modify (change)	SHIFT → WRITE → SET → Step number → GO → Com → GO

20.3.3 Operation in Read mode (R)

Details	Purpose	Procedures (key input sequence)
Command reading with the specified step number	Read the command of the specified step number in the program.	READ → SET → Step number → GO → GO
Read the command with the specified command.	Read the specified command in the program.	READ → Command → Device → Device number → GO → GO
Read the command with the specified device.	Read the command with the specified device used in the program.	READ → SET → Device → Device number → GO → GO
Automatic scroll	Display the program with automatic scroll.	Read operation above → SET → ↑ ↓ SET → Step number → ↑ ↓ SET → SP → ↑ ↓

20.3.4 Operation in Insert mode (I)

Details	Purpose	Procedures (key input sequence)
Insert a command in the program.	Insert a command in the program.	INSERT → SET → Step number → GO → Com → GO ↑ ↓
Move the program.	Move the whole program.	Display the program → HELP → 1 → 2 → Specify the movement start step. GO → Specify the movement end step → GO → Specify the movement destination step → GO
Copy the program.	Copy the program.	Display the program → HELP → 1 → 3 → Specify the copy start step. GO → Specify the copy end step → GO → Specify the copy destination step → GO

20.3.5 Operation in Delete (D) mode

Details	Purpose	Procedures (key input sequence)
Delete a command from the program.	Delete a command from the program.	SHIFT → DELETE → SET → Step number → GO → GO ↑ ↓
Delete the specified range of the program.	Specify the range of the program for deletion.	Display the program → HELP → 1 → 1 → Specify the deletion start step. GO → Specify the deletion end step → GO
Delete the whole NOP.	Delete the whole NOP in the program.	Display the program → HELP → 1 → 2

20.3.6 Operation in Parameter mode (P)

Details	Purpose	Procedures (key input sequence)
Clearing all parameters	Return the parameters to the initial setting status.	PARAM → 1 → ↑ → GO → END → ↑ → GO
Parameter setting (for A0J2HCPU)	Set the parameters for the A0J2HCPU.	PARAM → 2 → 1)
Setting of latch range	Select the latch range from "No latch", "1/2 latch" and "All latch".	1) → 1 → ↑ → GO → 2)
Setting of step relay	Set the availability (S1536 to 2047) of the step relay.	1) → 2 → ↑ → GO → 2)
Completion of setting (write)	When the parameter setting is complete, write the PLC CPU.	2) → CLEAR → END → ↑ → GO (End of writing is displayed.)
Parameter setting (other than A0J2HCPU)	Set the parameters other than A0J2HCPU.	PARAM → 2 → 1)
Setting of memory capacity	Set the main sequence program capacity and the file register capacity.	1) → 1 → Capacity → GO → END → 2) (For main, input unit: 1K step) 1) → 1 → ↓ → Capacity → GO → END → 2) (For sub, input unit: 1K step) 1) → 1 → ↓ → points → GO → END → 2) (For file register, input unit: 1K point)
M, L, S setting (other than AnA, AnUCPU)	Set the top device number used in the latch relay/step relay.	1) → 2 → Top number of L → GO → Top number of S → GO → 2)
M, L, S setting (AnA, AnUCPU only)	Set the top device number used in the latch relay/step relay/internal relay.	1) → 2 → Top number of L → GO → Top number of S → GO → Top number of M → GO → 2)
Timer setting (other than AnACPU)	Set the top device used in the low speed/high speed/retentive timers.	1) → 3 → Top number of timer → GO → 2)
Timer setting (AnACPU)	Set the number of timers used, the top device number that stores the setting value after T256, and the top device used in the low speed/high speed/retentive timers.	1) → 3 → No. of timers → GO → Top device for storage of setting values → GO → Top number of timer → GO → 2)
Counter setting (AnACPU only)	Set the number of counters used, and the top device number that stores the setting value after C255.	1) → 4 → No. of counters → GO → Top device for storage of setting values → GO → 2)
Setting of latch range	Set the range of the device for latch setting.	1) → 5 → ↑ → Top number of latch → GO → ↓ → End number of latch → GO → ↑ → GO → 2)
WDT setting	Set the value of the watchdog timer in the unit of 10 ms.	1) → 6 → WDT value → GO → 2) (input unit: 10 ms)
Setting of I/O control system (only for A3HCPU and A3MCP)	Set the I/O control system.	1) → 7 → ↑ → GO → 2)
Completion of setting (write)	When parameter setting is complete, write the PLC CPU.	2) → CLEAR → END → ↑ → GO (End of writing is displayed.)

20.3.7 Operation in Other modes (O)

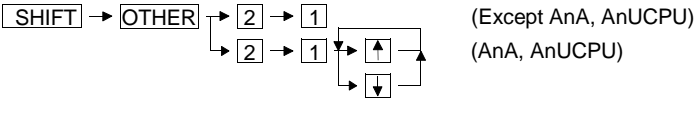
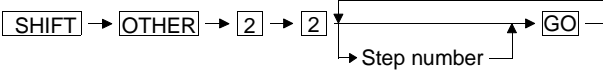
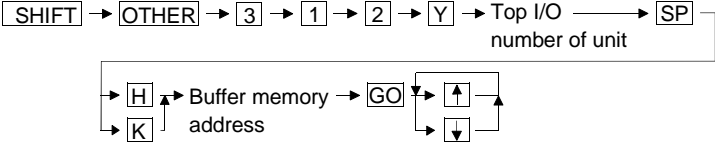
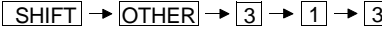
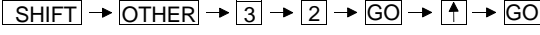
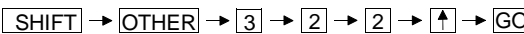
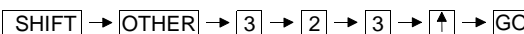
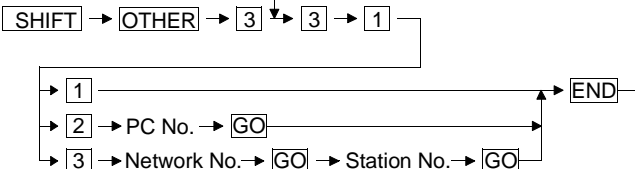
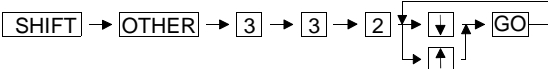
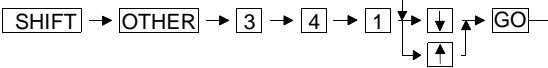
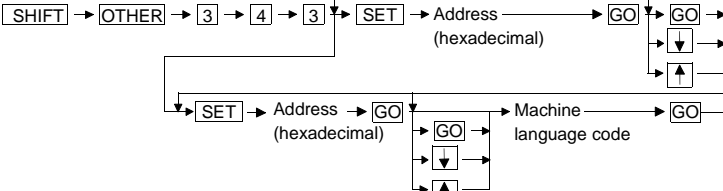
Details	Purpose	Procedures (key input sequence)
Error check	Operation that checks the error step number/error code for the current error in the ACPU. (other than AnA and AnUCPU)	
Program check	Check the program (double coil, command code, END command).	
Buffer memory batch monitoring	Monitor the buffer memory details of the special function unit.	
Clock monitor	Monitor the clock data of the ACPU.	
Clearing of all PC memories	Clear all memories in the ACPU.	
Clearing of all programs	Clear all sequence program, microcomputer program and T/C setting value areas.	
Clearing of all device memories	Clear all details of the bit device and the word device in the ACPU.	
PLC No. setting	Set the PLC No. of other stations for access on the MELSECNET II (/B) or MELSECNET/10.	
Main/sub-program switching	Select the main/sub-program displayed on the list edit screen.	
Remote run/stop	Operate the run/stop status of the ACPU from the GOT.	
Read/write of machine language	Specify the memory address (absolute address) of the ACPU. Read the memory details and write the machine language to the memory.	

CHAPTER21 ERROR DISPLAY AND CORRECTIVE ACTIONS FOR LIST EDIT

21.1 Error detected with the list editor function

If an error is detected with the list editor function during operation of each mode, an error message appears at the 4th line of the display.

Error messages, display conditions and corrective actions are displayed below. If an error message appears, take the following actions to resume operation.

- 1) Check the error message.
 - 2) Remove the cause of the error.
 - 3) Input the corresponding key.
- (The error message disappears. The screen returns to the status before error.)

(Example)

```

R   0 ▶ L D      X 0 0 0 0
▲   1   O R      Y 0 0 2 0
    2   A N I    M 1 0 0
    3   O U T    Y 0 0 2 0
    
```

RST → **M** → **0** → **GO**

..... Reading the step with the RST command.

```

R   0 ▶ L D      X 0 0 0 0
▲   1   O R      Y 0 0 2 0
    2   A N I    M 1 0 0
NOT FOUND
    
```

← Display the error message.

SET

..... Delete the error message.

```

R   0 ▶ L D      X 0 0 0 0
▲   1   O R      Y 0 0 2 0
    2   A N I    M 1 0 0
    
```

← The error message disappears.
The next operation is resumed.

Error message	Display condition	Action
Address error	<ul style="list-style-type: none"> In machine language writing, the address which was tried to be written was at the write-protect area. 	<ul style="list-style-type: none"> Set the correct address.
No corresponding program	<ul style="list-style-type: none"> The specified command was not found. 	<ul style="list-style-type: none"> Check the program.
Memory cassette check	<ul style="list-style-type: none"> In communication with the CPU for clearing the keyword or writing the parameter, the memory cassette is insufficient or not mounted. 	<ul style="list-style-type: none"> Mount the memory cassette properly. Replace the memory cassette with a new one.
Step over error	<ul style="list-style-type: none"> The set step number is larger than the maximum step number. 	<ul style="list-style-type: none"> Set the correct step number.
Setting error	<ul style="list-style-type: none"> Setting value is not correct. 	<ul style="list-style-type: none"> Set the correct value.
Not selectable	<ul style="list-style-type: none"> The function which cannot be executed was selected. 	<ul style="list-style-type: none"> Select other function.
Operation error	<ul style="list-style-type: none"> The set device symbol is incorrect. 	<ul style="list-style-type: none"> Perform the correct key operation.
Device error	<ul style="list-style-type: none"> The specified command was not found. The device number exceeds the range. 	<ul style="list-style-type: none"> Set the correct device symbol. Set the number within the range of CPU device.
Identical coil	<ul style="list-style-type: none"> The identical coil is found in the sequence program. 	<ul style="list-style-type: none"> Proceed to the next operation if it does not affect the control. Correct the program if it affects the control.
Command error	<ul style="list-style-type: none"> When the program is read, it cannot be converted to the proper command. 	<ul style="list-style-type: none"> When the CPU has detected the error, stop running of the operation. After resetting the CPU, check the command around the error. Write the correct command. (For check of the error step, refer to 20.3.7.)
Command setting error	<ul style="list-style-type: none"> The command set at the time of read, write or insert is not correct. 	<ul style="list-style-type: none"> Set the correct command.
Memory protect	<ul style="list-style-type: none"> When writing in the Write or the Insert/Delete mode, the memory protect switch in the memory cassette is ON. 	<ul style="list-style-type: none"> Turn OFF the memory protect switch in the memory cassette.
Capacity over	<ul style="list-style-type: none"> Memory assignment set in the parameter exceeded the capacity of the memory cassette. 	<ul style="list-style-type: none"> Set the parameter within the capacity of the memory cassette.
No END command	<ul style="list-style-type: none"> There is no END command. 	<ul style="list-style-type: none"> Write the END command at the last step of the program.
PLC communication error	<ul style="list-style-type: none"> When the list editor function is started, proper communication with the PLC is not made. 	<ul style="list-style-type: none"> Restart the list editor function. If communication is not made properly, check the following: GOT main unit Connection of the cable CPU main unit (if any error has occurred)
PC write error	<ul style="list-style-type: none"> Correct writing was not made in the Write or Insert mode. 	<ul style="list-style-type: none"> Check the setting of RAM/ROM. Check the RAM mounting. Check the setting of the memory protect switch in the CPU.
PLC is running	<ul style="list-style-type: none"> Writing, insertion or deletion was attempted during running of the CPU. 	<ul style="list-style-type: none"> Stop the CPU.
PC No. error	<ul style="list-style-type: none"> The PLC number is set to other station. 	<ul style="list-style-type: none"> Change the PLC number and set the station for access to the host.

Error message	Display condition	Action
**KS over	<ul style="list-style-type: none"> The value exceeding the range of the program capacity by **K steps was attempted to be set. 	<ul style="list-style-type: none"> Reduce the program capacity by **K steps for setting.
**KP over	<ul style="list-style-type: none"> The value exceeding the range of the file register capacity by **K points was attempted to be set. 	<ul style="list-style-type: none"> The value exceeding the range of the file register capacity by **K points was attempted to be set.
Not available for QnACPU. Set the PLC No.	<ul style="list-style-type: none"> The CPU at the list edit destination is QnACPU. 	<ul style="list-style-type: none"> Set the PLC number and change the station for access.
The keyword is not input. Set the PLC No.	<ul style="list-style-type: none"> The <input type="text" value="GO"/> key was pressed without input of the keyword on the keyword input screen. 	<ul style="list-style-type: none"> Set the PLC number and change the station for list edit. Or select the same station and input the keyword.
The PLC parameter was changed. Restart the GOT system.	<ul style="list-style-type: none"> The PLC parameter exceeding the file (R) register capacity was set. 	<ul style="list-style-type: none"> Restart the GOT system if required.
The PLC parameter was changed. Read the ladder monitor again.	<ul style="list-style-type: none"> The capacity of the file (R) register was set. 	<ul style="list-style-type: none"> Read the ladder monitor on the PLC again if required.
The PLC program was edited. Read the ladder monitor again.	<ul style="list-style-type: none"> Edit the PLC program. 	<ul style="list-style-type: none"> Set the PLC number and change the station for access.

21.2 Error of PLC CPU

When the error step read in other mode is performed, the error message and the error step of the current error in the ACPU are displayed.

Error messages, error details and corrective actions are displayed below. If an error message appears, take the following actions to resume operation.

- 1) Check the error message.
- 2) If the error code is not displayed, check the error code of special register D9008 with the system monitor function (Refer to Chapter 8.).
- 3) Remove the cause of the error.

(Display)

Example of display for an error in the CPU other than AnA and AnU

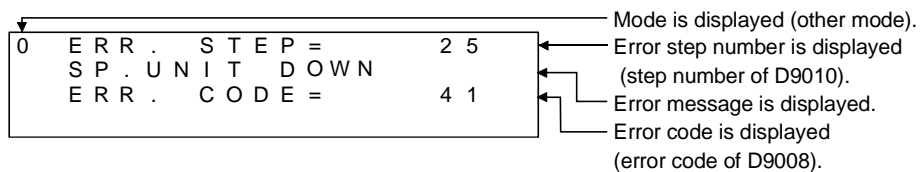

Example of display for an error in the AnA or AnUCPU

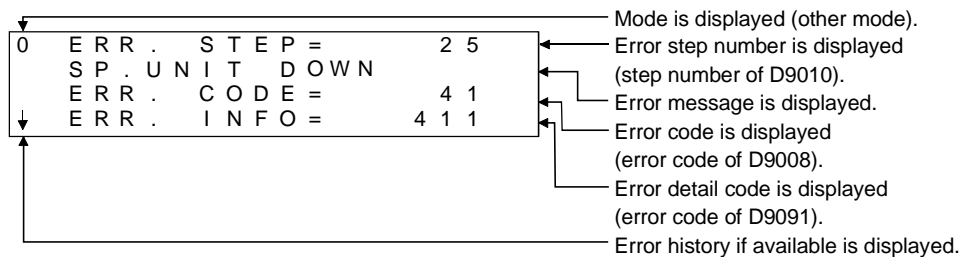

Example of next display for the display of "↓" above (error history is available)

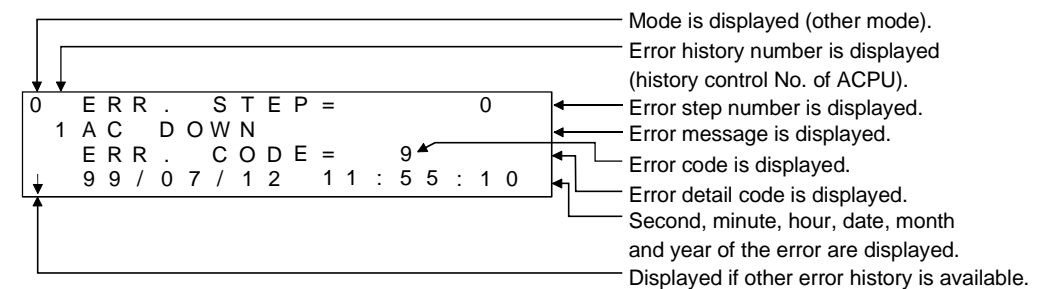

POINT

When an error message of the PLC CPU appears, refer to the ACPU programming manual (Common Command) and the user's manual for each CPU for corrective actions.

21.3 Error using list editor function on the link system

When the list editor function is used on the link system, the "PLC communication error (**)" may appear. In this case, check the error details and the corrective actions.

Error No.	Error message	Action
2	Time-out error: No response to the request	Check the cable wiring.
4	Process cancel: New process request was given to the list editor function while the CPU is processing.	Perform correct key operations on the GOT.
5	Sum check error: A sum check error from the link communication has occurred.	There may be noise interference. Check the system again.
16	PLC No. error: There is no station corresponding to the PLC number.	Check the PLC number setting. Set the correct number.
19	This error may occur when the ACPU is reset during monitoring.	Perform the monitor setting again.
24	Remote error: Although remote stop/pause is performed from the computer link unit, remote run/stop is additionally performed.	Perform the remote run/stop/pause from either unit.
32	Link error: While the slave station is monitoring the master station, the master station is reset.	Perform the monitor setting again.
34	EEPROM failure: The EEPROM, cannot be written due to EEPROM failure.	Replace the EEPROM with a new one.

If error number "25" appears, the following causes are possible. Check the details and the corrective actions.

(1) When connected to the master station

Device number	Description	Details	
M9210	Link card error (for master station)	OFF: Normal ON : Error	The control depends on whether there is an error at the hardware of the link card. The link card in the CPU link unit is judged at the CPU. Replace the link unit.
M9224	Link status	OFF: Online ON : Offline, station-to-station test, or self-loopback test	The control depends on whether the master station itself is online or offline, or in the station-to-station mode or the self-loopback mode. Check the mode switch.
M9227	Loop test status	OFF: Not executed ON : Normal loop test and sub-loop test are being executed.	The control depends on whether the master station itself is executing the normal loop test or the sub-loop test.

(2) When connected to the local station

Device number	Description	Details	
M9211	Link card error (for local station)	OFF: Normal ON : Error	The control depends on whether there is an error at the hardware of the link card. The link card in the CPU link unit is judged at the CPU. Replace the link unit.
M9240	Link status	OFF: Online ON : Offline, station-to-station test, or self-loopback test	The control depends on whether the local station itself is online or offline, or in the station-to-station mode or the self-loopback mode. Check the mode switch.
M9257	Loop test status	OFF: Not executed ON : Normal loop test and sub-loop test are being executed.	The control depends on whether the local station itself is executing the normal loop test or the sub-loop test.

(3) When connected to the CPU in MELSECNET/10

An error in the MELSECNET/10 is reported using a four digit (hexadecimal) error number.

For details of the errors and corrective actions, see the MELSECNET/10 Network System Reference Manual.

POINT

If an error code not listed in the previous page is displayed, contact the nearest of our system service centers, agents, and branch offices.

CHAPTER22 OPERATION PROCEDURES FOR MOTION MONITOR FUNCTION

The operation procedure when using the motion monitor function is explained in this chapter.

22.1 Operation procedures before starting motion monitoring

This section contains a summary of the procedure for transmitting the system program (OS) for the motion monitor function and the motion monitor data from the personal computer to the GOT until it is installed in built-in memory.

For details, please refer to the Help in GT Designer. Details of the screen display and key operation are shown in the Help.

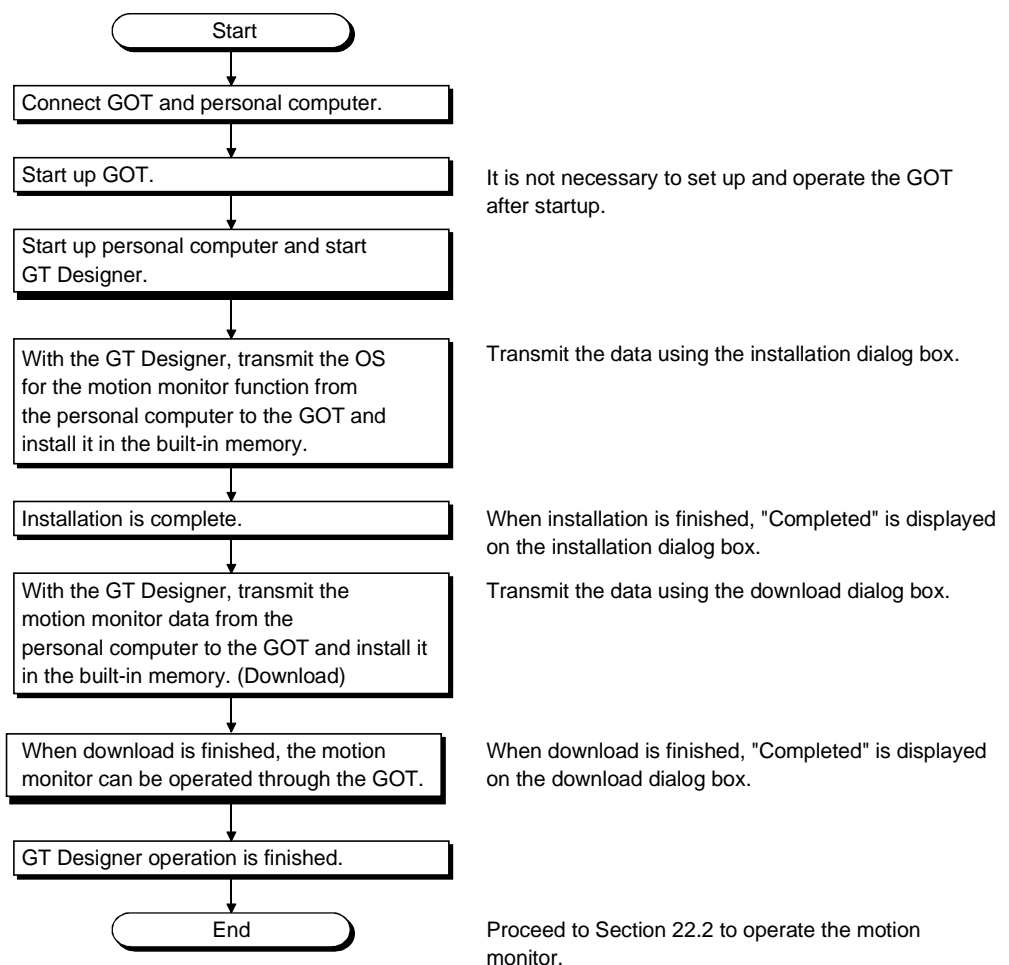

22.2 Operation procedures from user-created monitor screen display to start of motion monitor

This section describes the operation procedure for the GOT when starting each operation of the motion monitor function after the system program (OS) of the motion monitor function has been installed in the GOT built-in memory, and downloading the motion monitor data.

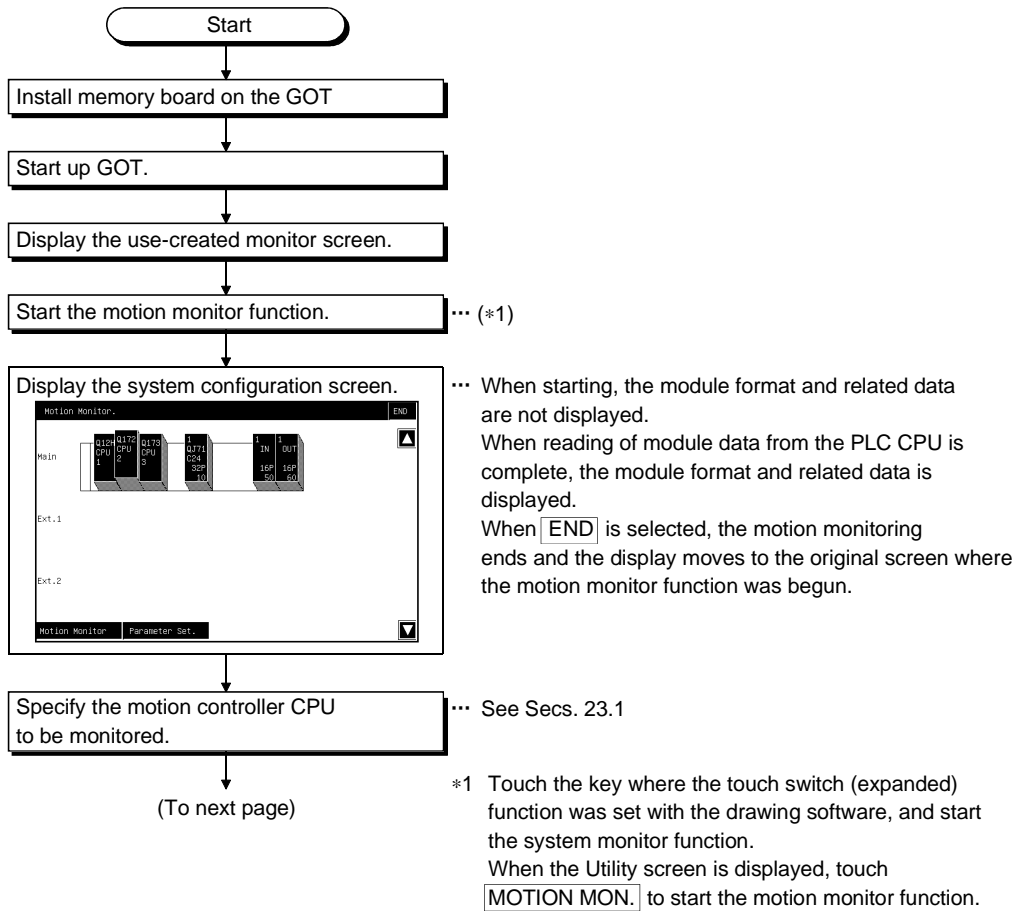

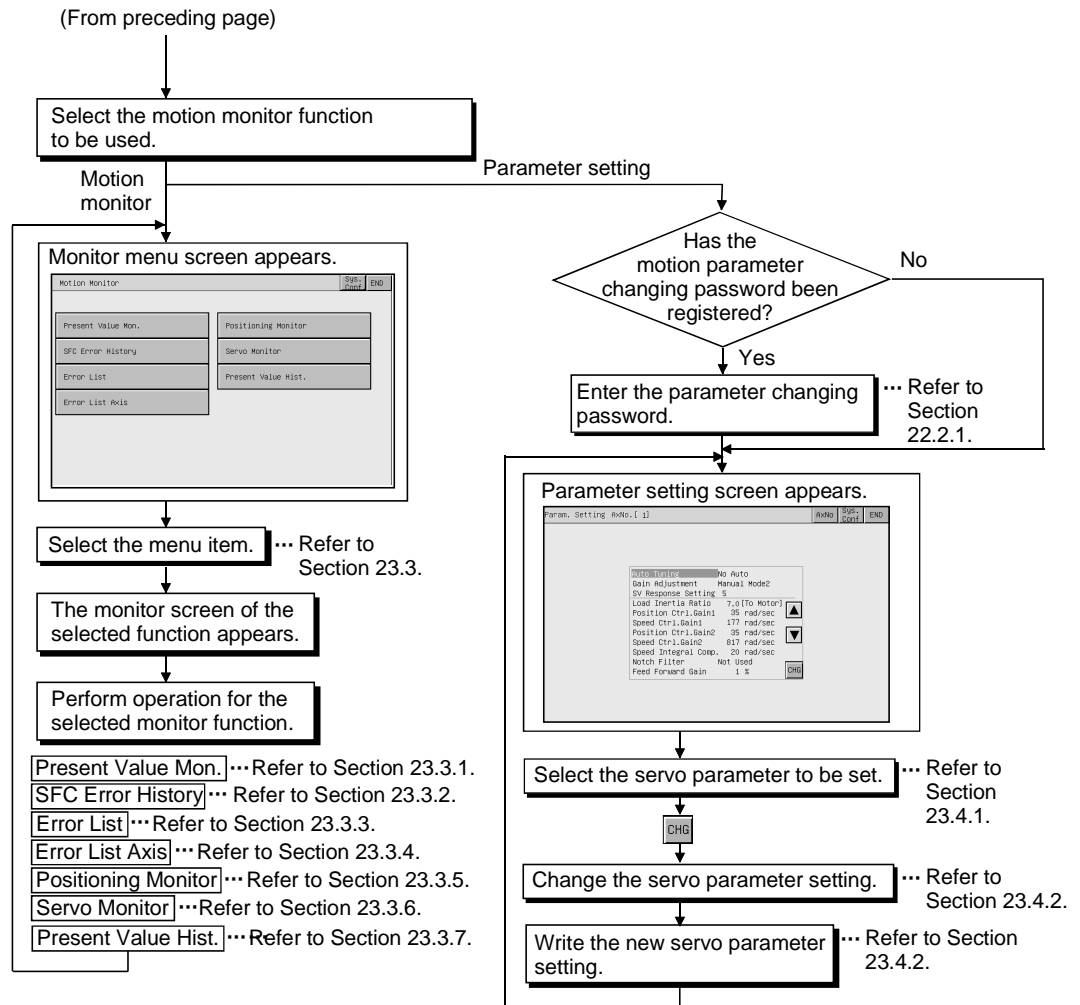

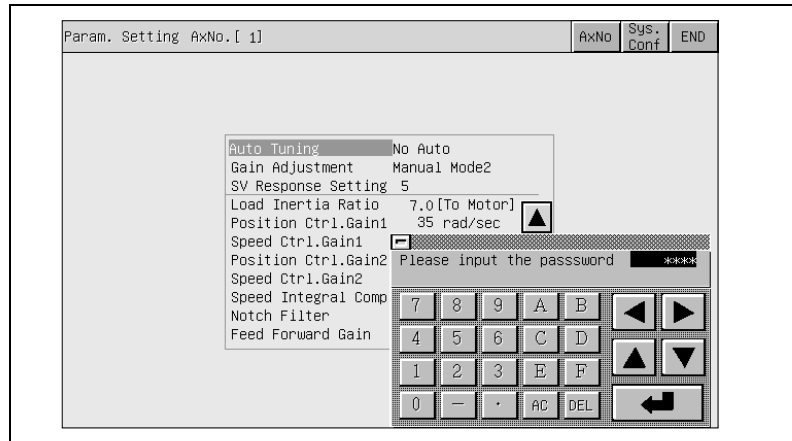

22.2.1 Password entry operation procedure

With the motion parameter changing password written to the GOT using GT Designer, the password entry screen appears if you attempt to access the parameter setting screen of the motion monitor function.









(1) Features

- If the characters entered match a password, the Parameter Setting screen appears.
- If the characters entered do not match a password, an error message appears on-screen. Touching  will return to the previous monitor screen.
- Numerical numbers and alphabets  to  can be used for a password.
- Use GT Designer to set the motion parameter changing password. Refer to the help function of GT Designer for details of password setting.

(2) Procedure

(a) To enter a password, follow these steps:

- Touch  to  and  to  to enter a password.
- Touch  to confirm the password entered.
- To correct the password entered, touch  to delete wrong characters and then enter correct characters again.

(b) To quit entering a password:

- Touch  to return to the previous monitor screen.

CHAPTER23 OPERATIONS OF VARIOUS MOTION MONITOR SCREENS

This chapter explains screen operations to be performed when using the motion monitor function.

The display screen of the motion monitor function varies slightly with the GOT used. This chapter mainly uses the screen of the A975GOT for explanation.

23.1 Screen layout, common operations and screen changes for monitoring

This section describes the screen layout and common operations for execution of motion monitoring.

23.1.1 System configuration screen layout and key functions

This section explains the layout of the system configuration screen that is displayed after starting the motion monitor function and the key functions that appears on-screen.

(1) Displayed data

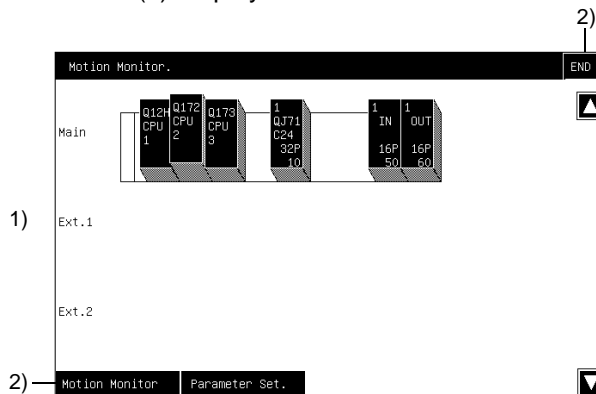

Module types and like are displayed on completion of reading module information from PLC CPU. (Automatically displayed by OS)

1)	The CPU No. is displayed as the CPU and the control CPU No. as the loaded module. (Only the CPU is displayed when the A95*GOT/A956WGOT is used.) To choose the motion controller CPU for servo monitor/servo parameter setting, touch its display position.
2)	The keys used for performing operation on the system configuration screen, shown in (2), are displayed. (Touch input)

(2) Key functions

The following indicates the functions of the keys used for performing operation on the system configuration screen.

Key	Function
	Used to end monitoring and return to the screen where the motion monitor function was started.
	Used to select the motion controller CPU where servo monitor/servo parameter setting will be performed.
	Used to change the system configuration screen to the motion monitor menu screen. (Refer to Section 23.4)
	Used to change the system configuration screen to the parameter setting screen. (Refer to Section 23.5)
	Used to scroll the display data up/down one level to display the currently undisplayed, preceding/succeeding level of the system configuration. ▼: Scrolls down one level. ▲: Scrolls up one level.

23.2 Changing the screen

This section describes how to change the screen when executing each monitor function of the motion monitor function from the status where the user-created monitor screen is displayed.

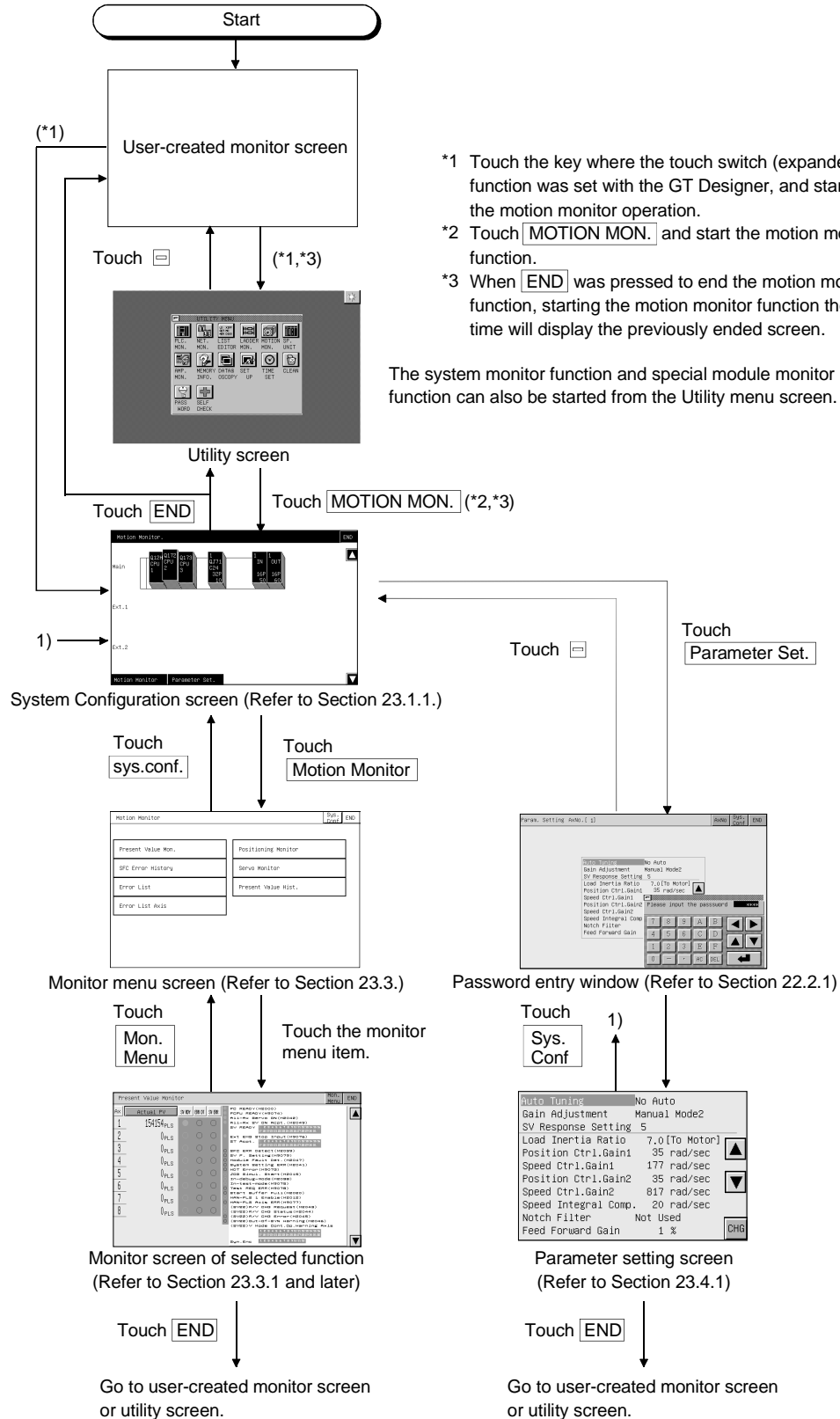

- *1 Touch the key where the touch switch (expanded) function was set with the GT Designer, and start the motion monitor operation.
- *2 Touch **MOTION MON.** and start the motion monitor function.
- *3 When **END** was pressed to end the motion monitor function, starting the motion monitor function the next time will display the previously ended screen.

The system monitor function and special module monitor function can also be started from the Utility menu screen.

23.3 Motion monitor

The motion monitor function allows you to monitor various servo monitor data on multiple monitor screens.

To display any of the monitor screens, make selection on the monitor menu screen.

(Monitor menu screen)

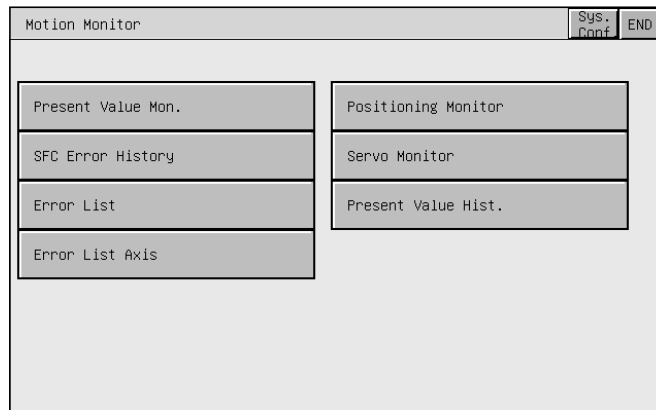

- 1) Present Value Mon. ... Monitors and displays the feed current values and actual current values of all running axes. (Refer to Section 23.3.1)
- 2) SFC Error History..... Displays the history of errors that occurred in SFC programs from when the motion CPU was powered on or reset. (Refer to Section 23.3.2)
- 3) Error List..... Displays the history of errors (eight latest errors) that occurred on and after the leading edge of PLC ready (M2000). (Refer to Section 23.3.3)
- 4) Error List Axis..... Displays the latest errors that occurred on the specified axis. (Refer to Section 23.3.4)
- 5) Positioning Monitor Monitors the details of the positioning data set to any axis. (Refer to Section 23.3.5)
- 6) Servo Monitor..... Monitors the servo motor/servo amplifier. (Refer to Section 23.3.6)
- 7) Present Value Hist. Displays the history of encoder present values, servo command values and monitor present values of the ABS axis at servo amplifier power-on/off or at home position return. (Refer to Section 23.3.7)
(Not displayed when the A95*GOT is used.)

23.3.1 Display data and key functions of present value monitor screen

This section explains the display data of the present value monitor screen and the key functions displayed on-screen.

(1) Displayed data

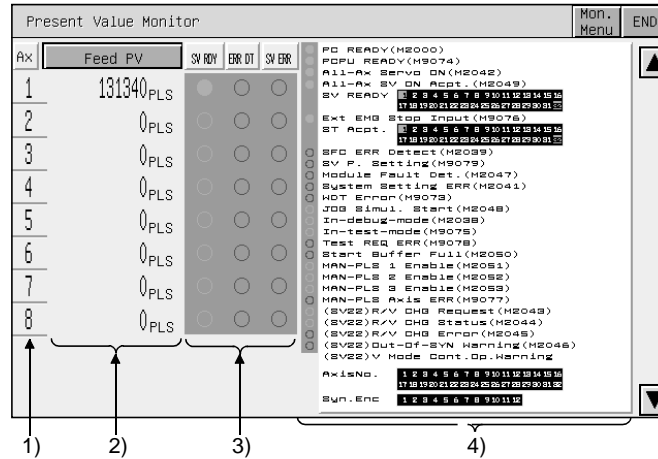

No.	Item	Description
1)	Ax	The axis Nos. of the running axes being monitored are displayed.
2)	Actual PV Feed PV	The feed present values or actual present values of the running axes are displayed. Touching the display part of the monitored value switches to the positioning monitor screen of the touched axis No. (Refer to Section 23.3.5)
3)	SV RDY, ERR DT, SV ERR	Whether the servo ready signals, major/minor errors and servo error detection signals are ON (lit) or OFF (extinguished) are displayed. Touching the error indication part "●" switches to the error list designated-axis screen of the touched axis No. (Refer to Section 23.3.4)
4)	Bit device screen *1	The common bit devices are always monitored and displayed. ● Error detection type bit devicesDisplayed red ● General status type bit devicesDisplayed green

*1 Not displayed when the A95*GOT/A956WGOT is used.

(2) Key functions

The following indicates the functions of the keys used for operation of the present value monitor screen.

Key	Function
Feed PV	Touching the key alternates the monitor item between the "feed present value" and "actual present value". (Only in the real mode)
Actual PV	
Mon. Menu	Used to return to the monitor menu screen.
END	Used to end the present value monitoring and return to the screen that was being displayed when the motion monitor function was started.
▲ ▼	Used to change the displayed axis No. (Displayed only for Q173CPU monitoring.)

23.3.2 Display data and key functions of SFC error history screen

This section explains the display data of the SFC error history screen and the key functions displayed on-screen.

(1) Displayed data

SFC Error History				Mon. Menu	END
M/ D	Program No.	Err	Error Definition		
H: M	SFC-F/G/K-BKNo	Code			
7/24 10:50	SFC F/G/K B10ck 20	5 1004	At a start, sv.ampl.is OFF, initial processing, the amp.is not yet installed,a sv.err.occurred,or the cable is faulty.		
7/24 10:50	SFC F/G/K B10ck 21	4	Demand speed outside the range		
7/24 10:50	SFC F/G/K B10ck 22	906	The unused axis was started.		
7/24 10:50	SFC F/G/K B10ck 103	906	The unused axis was started.		
7/24 10:50	SFC F/G/K B10ck 20	5 1004	At a start, sv.ampl.is OFF, initial processing, the amp.is not yet installed,a sv.err.occurred,or the cable is faulty.		
7/24 10:50	SFC F/G/K B10ck 21	4	Demand speed outside the range		
7/24 10:50	SFC F/G/K B10ck 22	906	The unused axis was started.		
7/24 10:50	SFC F/G/K B10ck 103	906	The unused axis was started.		



↑
↑
↑
↑
 1) 2) 3) 4)

No.	Item	Description
1)	M/D H: M	The dates and times when SFC errors occurred are displayed.
2)	Program No.	The SFC program Nos. where SFC errors occurred are displayed.
3)	Err Code	The error codes of the errors that occurred are displayed.
4)	Error Definition ^{*1}	The definitions of the SFC errors that occurred are displayed.

*1 Not displayed when the A95*GOT/A956WGOT is used.

(2) Key functions

The following indicates the functions of the keys used for operation of the SFC error history screen.

Key	Function
	Used to return to the monitor menu screen.
	Used to end the SFC error history and return to the screen that was being displayed when the motion monitor function was started.
	Used to scroll the SFC error history display. (Displayed only when the A95*GOT/A956WGOT is used.)

23.3.3 Display data and key functions of error list screen

This section explains the display data of the error list screen and the key functions displayed on-screen.

(1) Displayed data

Error List					Mon-Menu	END
M/ D	Ax	SV P. No.	Err Code	Error Definition	Set Data	
7/24				SV P		
10:50		103	906	The unused axis was started.	906	
7/24				MaJ. At a start, sv.ampl.is OFF, initial processing, the amp.is not yet installed,a sv.err.occurred,or the cable is faulty.		
10:50	5	20	1004			
7/24				SV P		
10:50		21	4	Command speed outside the range	4	
7/24				SV P		
10:50		22	906	The unused axis was started.	906	
7/24				SV P		
10:50		103	906	The unused axis was started.	906	
7/24				MaJ. At a start, sv.ampl.is OFF, initial processing, the amp.is not yet installed,a sv.err.occurred,or the cable is faulty.		
10:51	5	20	1004			
7/24				SV P		
10:51		21	4	Command speed outside the range	4	
7/24				SV P		
10:51		22	906	The unused axis was started.	906	

- 1) 2) 3) 4)

No.	Item	Description
1)	H/D H: M	The dates and times when errors occurred are displayed.
2)	Ax	The axis Nos. and axis types of the axes where errors occurred are displayed. Virtual axis : Virtual Synchronous encoder axis : Sync
3)	SV P. No.	The servo program Nos. that were being executed at error occurrence are displayed. The execution destination of the servo program in error is not displayed. Using the servo program No., refer to the execution destination.
4)	Err Code	The types and error codes of the errors that occurred are displayed. The error types are displayed as indicated below. <ul style="list-style-type: none"> • Minor error.....Minor • Major error.....Major • Servo errorServo • Servo program setting error.....Servo P • Real/virtual switchingSwitch • Test mode request errorTest • Manual pulse generator setting errorManual • PCPU ERROR.....P-WDT • SSCNET ERRORCommunication error
5)	Error Definition *1	The definitions of the errors that occurred are displayed.
6)	Set Data *1	The program number in error is displayed if the set data have any errors.

*1 Not displayed when the A95*GOT/A956WGOT is used.

(2) Key functions

The following indicates the functions of the keys used for operation of the error list screen.

Key	Function
Mon-Menu	Used to return to the monitor menu screen.
END	Used to end the error list and return to the screen that was being displayed when the motion monitor function was started.

23.3.4 Display data and key functions of error list designated-axis screen

This section explains the display data of the error list designated-axis screen and the key functions displayed on-screen.

(1) Displayed data

(In real mode)

(In virtual mode)

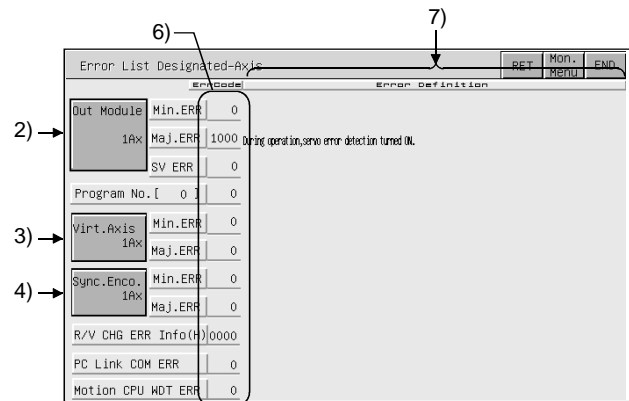
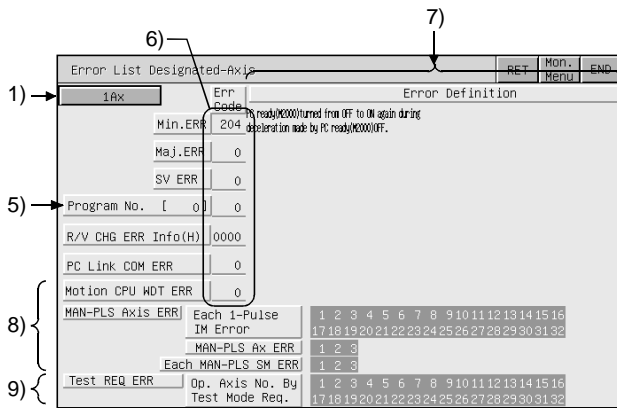

No.	Item	Description	
1)	1Ax	The axis No. currently monitored is displayed.	
2)	Out Module	The output module axis No. currently monitored is displayed.	
3)	Virt. Axis	The virtual axis No. currently monitored is displayed.	
4)	Syne. Enco.	The synchronous encoder axis No. currently monitored is displayed.	
5)	Program No.	The servo program No. that was being executed at error occurrence is displayed.	
6)	Err Code	The error codes of the minor/major/servo error, servo program setting error, real/virtual switching error information (error code: hexadecimal), personal computer link communication error code and motion CPU WDT error that are currently occurring are displayed.	
7)	Err Definition *1	The definitions of the errors that occurred are displayed.	
8)	MAN-PLS Axis ERR *1	Each 1-Pulse 1M Error	The axes where a 1-pulse input magnification setting error occurred are displayed.
		MAN-PLS AX ERR	The errors of the axis Nos. set to the manual pulse generators P1 to P3 are displayed.
		Each MAN-PLS SM ERR	The errors of the smoothing magnifications set to the manual pulse generators P1 to P3 are displayed.
9)	Test REQ ERR	The axis Nos. that are being started at a test mode request are displayed.	

*1 Not displayed when the A95*GOT/A956WGOT is used.

(2) Key functions

The following indicates the functions of the keys used for operation of the error list designated-axis screen.

Key	Function
<div style="border: 1px solid black; padding: 2px; margin-bottom: 5px; text-align: center;">1AX</div> (In real mode only), <div style="display: flex; justify-content: space-around; align-items: center;"> <div style="border: 1px solid black; padding: 2px; text-align: center;">Out Module 1AX</div> <div style="border: 1px solid black; padding: 2px; text-align: center;">Virt. Axis 1AX</div> </div> / <div style="border: 1px solid black; padding: 2px; text-align: center;">Sync. Enco. 1AX</div> / (In virtual mode only) (Display example: When axis 1 is monitored)	Used to change the axis to be monitored.
<div style="border: 1px solid black; padding: 2px; width: 40px; margin: 0 auto;">RET</div>	Used to return to the previous screen.
<div style="border: 1px solid black; padding: 2px; width: 40px; margin: 0 auto;">Mon. Menu</div>	Used to return to the monitor menu screen.
<div style="border: 1px solid black; padding: 2px; width: 40px; margin: 0 auto;">END</div>	Used to end the error list designated-axis monitoring and return to the screen that was being displayed when the motion monitor function was started.

23.3.5 Display data and key functions of positioning monitor screen

This section explains the display data of the positioning monitor screen and the key functions displayed on-screen.

(1) Displayed data

(In real mode)

(In virtual mode)

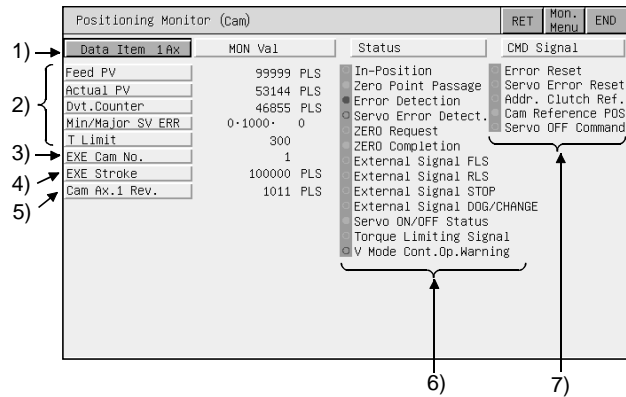
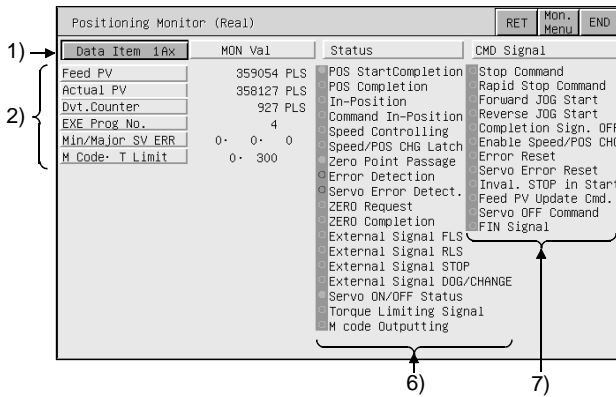





No.	Item	Description
1)	Data Item	The axis No. of the running axis being monitored is displayed. For the virtual axis, the axis type is displayed. <ul style="list-style-type: none"> • Roller • Ballscrew • Rotary table • Cam
2)	Feed PV	The data during positioning control of the PCPU are displayed. <ul style="list-style-type: none"> • Feed present value : Target address output to the servo amplifier (value of the roller surface speed for the roller axis) • Actual present value : Actually traveled present value (no value is displayed for the roller axis) • Deviation counter : Difference between feed present value and actual present value • Executed program No. : Servo program No. in execution • Minor/major/servo error : Error code of the latest minor/major/servo error
3)	EXE Cam No.	The cam No. currently controlled is displayed.
4)	ExE Stroke	The stroke amount currently controlled is displayed.
5)	Cam Ax.1 Rev.	The present value within one cam axis revolution pulse is displayed.
6)	Status *1	The ON and OFF of the symbols that represent the axis-by-axis control statuses are displayed. <ul style="list-style-type: none"> • In the ON status, the symbol is lit green. • At error or servo error detection, the symbol is lit red.
7)	CMD Signal *1	The ON and OFF of the positioning command signals are displayed. In the ON status, the signal is lit green.

*1 Not displayed when the A95*GOT/A956W/GOT is used.

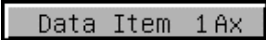
(2) Key functions

The following indicates the functions of the keys used for operation of the positioning monitor screen.

Key	Function
 (Display example: When axis 1 is monitored)	Used to change the axis to be monitored.
	Used to return to the previous screen.
	Used to return to the monitor menu screen.
	Used to end the positioning monitoring and return to the screen that was being displayed when the motion monitor function was started.

23.3.6 Display data and key functions of servo monitor screen

This section explains the display data of the servo monitor screen and the key functions displayed on-screen.

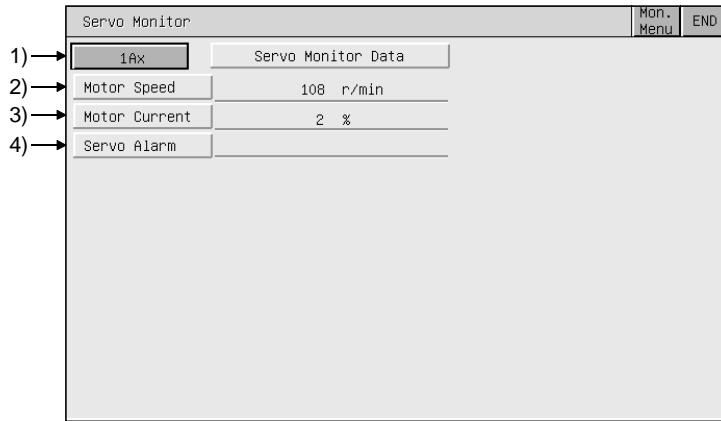

(1) Displayed data



No.	Item	Description
1)	Ax	The axis No. of the running axis currently monitored is displayed.
2)	Motor Speed	The actual speed of the servo motor is displayed.
3)	Motor Current	The motor current value at the rated current of 100% is displayed.
4)	Servo Alarm	The alarm detected by the servo amplifier is displayed.

(2) Key functions

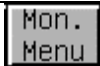
The following indicates the functions of the keys used for operation of the servo monitor screen.

Key	Function
 (Display example: When axis 1 is monitored)	Used to change the axis to be monitored.
	Used to return to the monitor menu screen.
	Used to end the servo monitoring and return to the screen that was being displayed when the motion monitor function was started.

23.3.7 Display data and key functions of present value history monitor screen

This section explains the display data of the present value history monitor screen and the key functions displayed on-screen.



(1) Displayed data

Present Value History Monitor							MON.	END
Item	M/ D	H: M	Encoder PV Multi Rev/1Rev	SV CMD Val	Monitor PV	ALM		
1Ax								
HP Data	7/ 9	13:43	0H·	0H	1BE9E0H	0	----	
MON Val	7/ 9	17:12	0H·	0H	1D7051H	99953.0000	----	
Nw PWR ON1	7/ 9	13:34	D7FEH·	45F3H	0H	0.0000	0	
PWR OFF1	7/ 9	13:34	0H·	0H	20B67DH	490142.0000	----	
PWR ON2	7/ 9	13:10	D7EDH·	19460H	0H	92274.0000	0	
PWR OFF2	7/ 9	13:10	0H·	0H	FFFFFFF0H	92274.0000	----	
PWR ON3	7/ 9	13:10	D7EDH·	19472H	0H	92290.0000	0	
PWR OFF3	7/ 9	13:10	0H·	0H	FFFFFFE0H	92290.0000	----	
Od PWR ON4	7/ 9	13:10	D7EDH·	19495H	0H	92322.0000	0	

No.	Item	Description
1)	Ax	The axis No. of the axis currently monitored is displayed.
2)	HP Data	The following values monitored at home position return are displayed. <ul style="list-style-type: none"> • Home position return completion time • Encoder present value • Multi-revolution data of absolute position reference point data • Within-one-revolution position of absolute position reference point data • Servo command value • Monitor present value
3)	MON Val	The following present monitor values are displayed. <ul style="list-style-type: none"> • Present time • Encoder present value • Present multi-revolution data of encoder present value • Present within-one-revolution position of encoder present value • Present servo command value • Present monitor present value
4)	PWR ON/ PWR OFF	The four past present values of the ABS axis at servo amplifier power-on/off are displayed. [At power-on] <ul style="list-style-type: none"> • Power-on time • Encoder present value • Multi-revolution data of initial encoder • Single-revolution data of initial encoder • Servo command value after recovery • Monitor present value after recovery • Alarm occurrence information at present value recovery (error code of minor/major error) [At power-off] <ul style="list-style-type: none"> • Servo amplifier power-off time • Encoder present value • Multi-revolution data of encoder present value before servo amplifier power-off • Single-revolution data of encoder present value before servo amplifier power-off • Servo command at servo amplifier power-off • Monitor present value at servo amplifier power-off

(2) Key functions

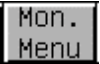
The following indicates the functions of the keys used for operation of the present value history monitor screen.

Key	Function
 (Display example: When axis 1 is monitored)	Used to change the axis to be monitored.
	Used to return to the monitor menu screen.
	Used to end the present value history monitoring and return to the screen that was being displayed when the motion monitor function was started.

23.4 Parameter setting

With the parameter setting function, you can set the servo parameters (basic parameters/adjustment parameters) of the connected motion controller CPU (Q172CPU, Q173CPU).

23.4.1 Display data and key functions of parameter setting screen

This section explains the display data of the parameter setting screen and the key functions displayed on-screen.

(1) Display screen

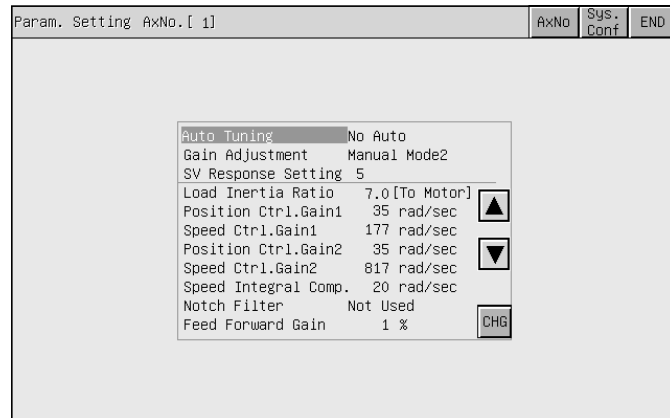

(2) Key functions

The following indicates the functions of the keys used for operation of the parameter setting screen.

Key	Function
	Used to change the servo parameter setting of the selected item.
	Used to choose the servo parameter setting item.
	Used to change the axis whose parameter setting will be made.
	Used to return to the system configuration screen.
	Used to end the parameter setting and return to the screen that was being displayed when the motion monitor function was started.

23.4.2 Parameter setting operation

The following describes the procedure of changing the setting of the "Auto Tuning" item as an example of parameter setting operation.

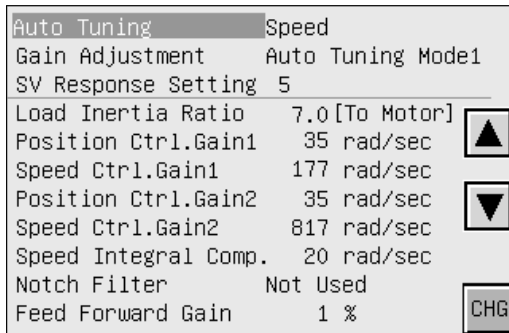

- 1) Choose the item whose parameter will be set with the ▲, ▼ key, and touch the CHG key.

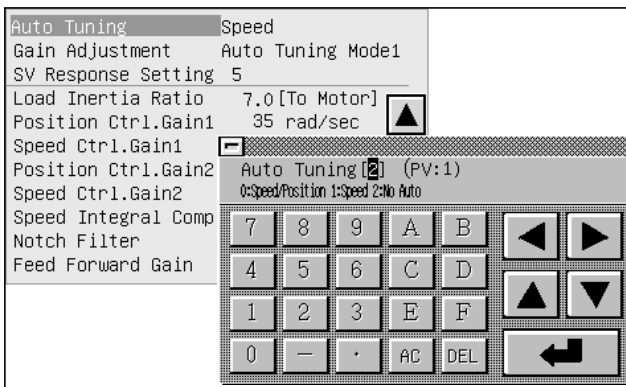
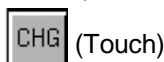

- 2) As the parameter setting window appears, enter the parameter setting data with Alphanumeric, and touch to confirm the setting. If you do not confirm it, touch to close the parameter setting window.

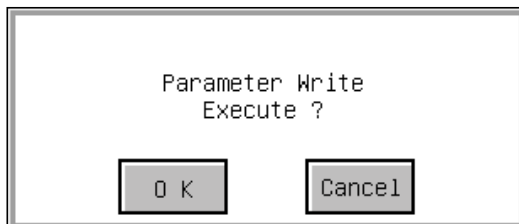
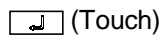

- 3) As the confirmation window appears, touch the OK key to write the parameter setting to the motion controller CPU. When you do not write the parameter setting, touch the Cancel key.

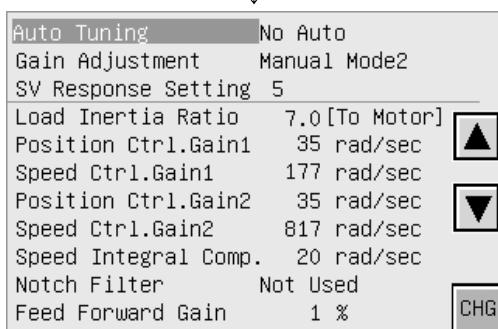
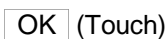

- 4) After completion of write, the parameter setting screen whose display has been updated to the new parameter setting appears.

23.5 About Hardcopy Output

This section describes the way to print the motion monitor screen with the printer or to save it in the PC card in the BMP/JPEG file format during motion monitor.

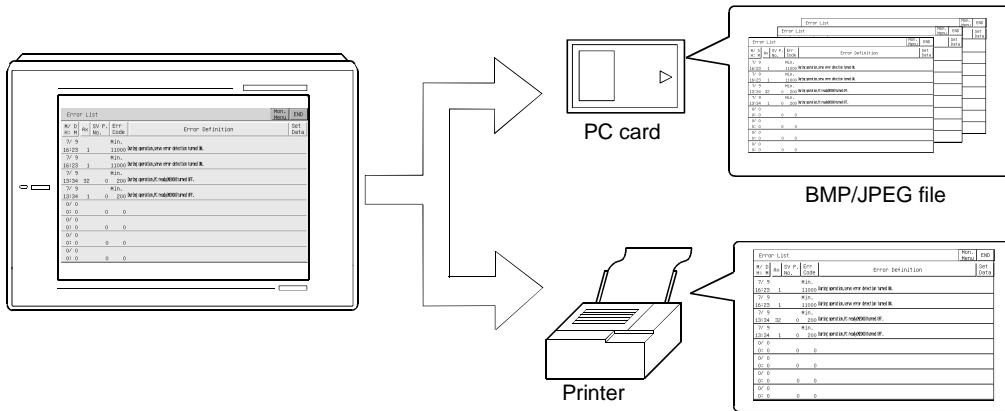

The printout method varies with the used GOT as described below.

- (1) When A985GOT or A97*GOT is used
 To start printout, touch the **Print Screen / Cancel Print** key displayed on the motion monitor screen.
- (2) When A95*GOT or A956WGOT is used
 To start printout, set the hardcopy function start/stop triggering device using GT Designer, and turn that set device on/off.

POINT	<ul style="list-style-type: none"> • Before printing out the motion monitor screen, always install the option driver into the GOT. • Set the output destination (PC card/printer) of the hardcopy in the hardcopy setting of GT Designer. Refer to Help of GT Designer for details of the hardcopy setting.
--------------	--

CHAPTER 24 ERROR DISPLAY AND HANDLING WITH MOTION MONITORING

This section gives the errors that may be displayed during motion monitoring operation and their corrective actions.

Error message	Error Definition	Corrective Action
No. PLC Communications	Communication with the monitor destination PLC CPU cannot be made.	<ul style="list-style-type: none"> • Check the connection status of the PLC CPU and GOT (for unplugged connector, open cable). • Check the PLC CPU for error occurrence.
This PLC type is not supported	The CPU selected on the system configuration screen is other than the Q172CPU or Q173CPU.	Choose the Q172CPU or Q173CPU on the system configuration screen.
Controllers' OS type is different	The motion controller OS installed into the monitor destination motion controller CPU (Q172CPU, Q173CPU) is other than SV13 or SV22.	Install SV13 or SV22 into the monitor destination motion controller CPU (Q172CPU, Q173CPU) as the motion controller OS.
It is not a version for GOT	The version of the motion controller OS installed into the monitor destination motion controller CPU is not compatible with the motion monitor function.	Install the motion controller OS whose version is "00E" or later into the motion controller CPU.
Monitor data not found	Monitor data was not installed or was deleted.	Download the monitor data of the motion monitoring.
Unused axis selected	The axis No. selected has not been set.	<ul style="list-style-type: none"> • Choose the axis No. that has been set. • Set the axis using the peripheral software.
It is not possible to select	During servo parameter setting, the item that cannot be set has been selected.	Choose the item that can be set.
Incorrect setting range	The value that is outside the setting range has been set.	Set the value within the setting range.
Unmatched password	The password entered as the motion parameter changing password is illegal.	Enter the correct password.

CHAPTER25 OPERATION PROCEDURES FOR SERVO AMPLIFIER MONITOR FUNCTION

The operation procedure when using the servo amplifier monitor function is explained in this chapter.

25.1 Operation procedures before starting motion monitoring

This section contains a summary of the procedure for transmitting the system program (OS) for the servo amplifier monitor function and the motion monitor data from the personal computer to the GOT until it is installed in built-in memory.

For details, please refer to the Help in GT Designer. Details of the screen display and key operation are shown in the Help.

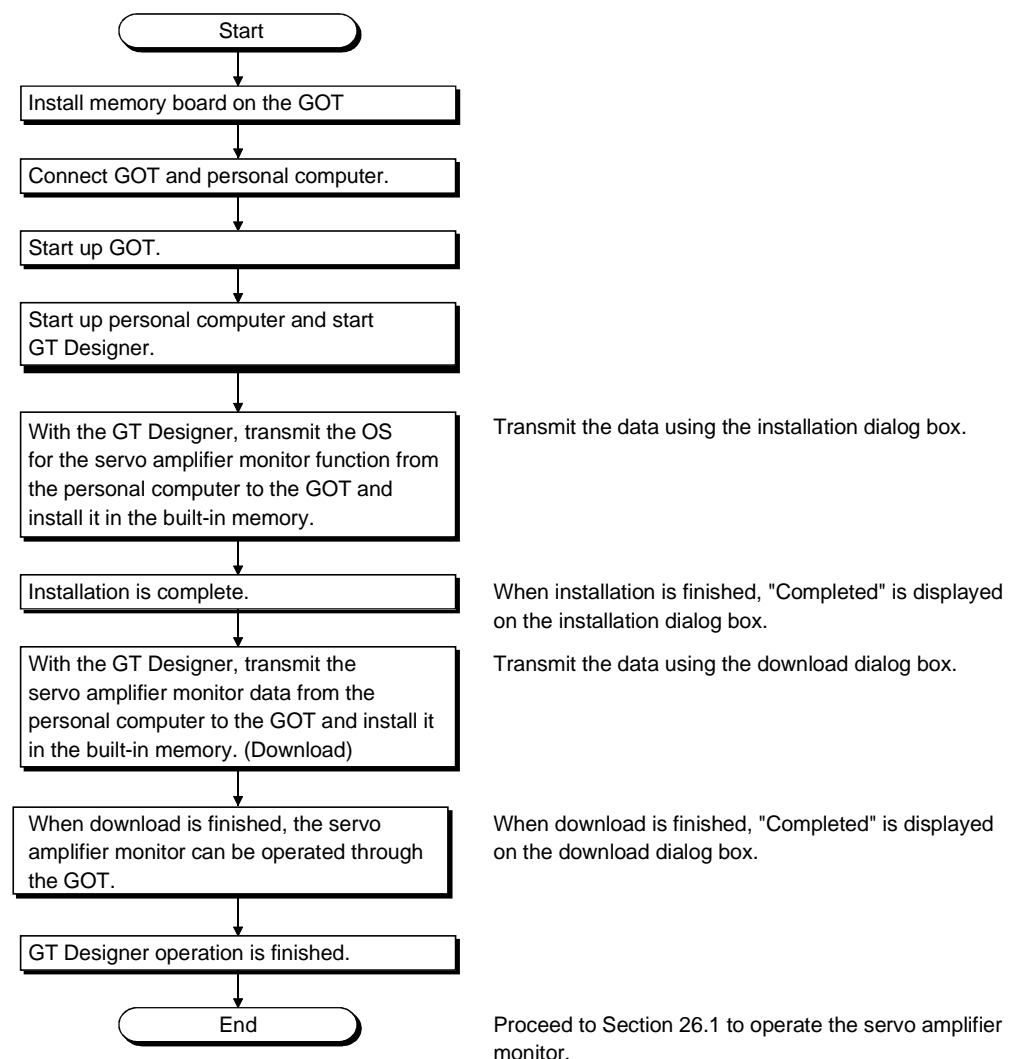

25.2 Operation procedures from user-created monitor screen display to start of motion monitor

This section provides the GOT operating procedure for starting the operation of any servo amplifier monitor function after completion of the installation of the "servo amplifier monitor function OS".

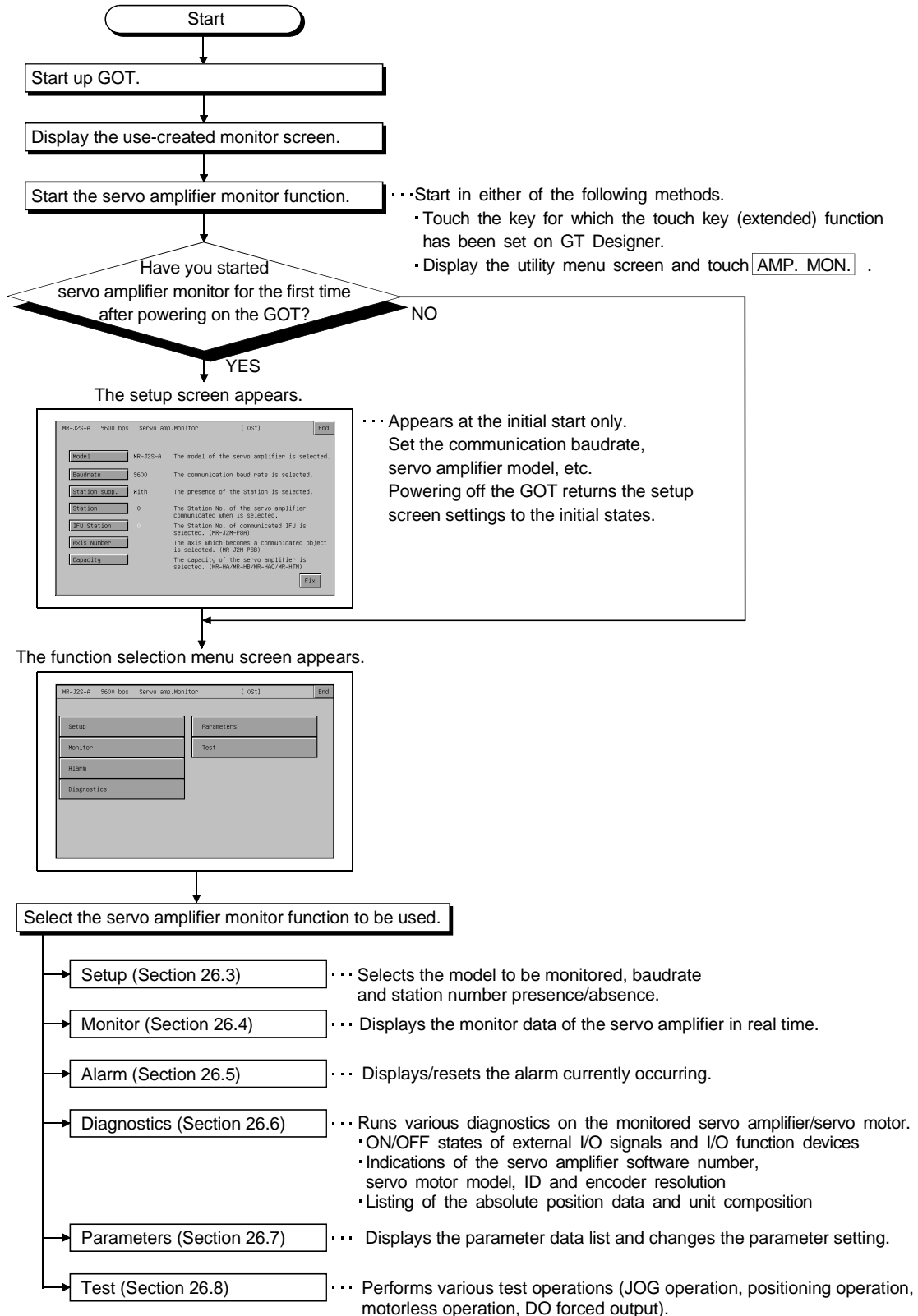

CHAPTER26 OPERATIONS OF SERVO AMPLIFIER MONITOR SCREENS

This chapter describes the screen operations to be performed when using the servo amplifier monitor functions.

The display screens of the servo amplifier monitor functions change slightly depending on the used GOT. This chapter mainly uses the screens of the A975GOT for explanation.

26.1 Screen Transition

This section gives the screen transition from the user-created monitor screen display status to the servo amplifier monitor function screen operations.

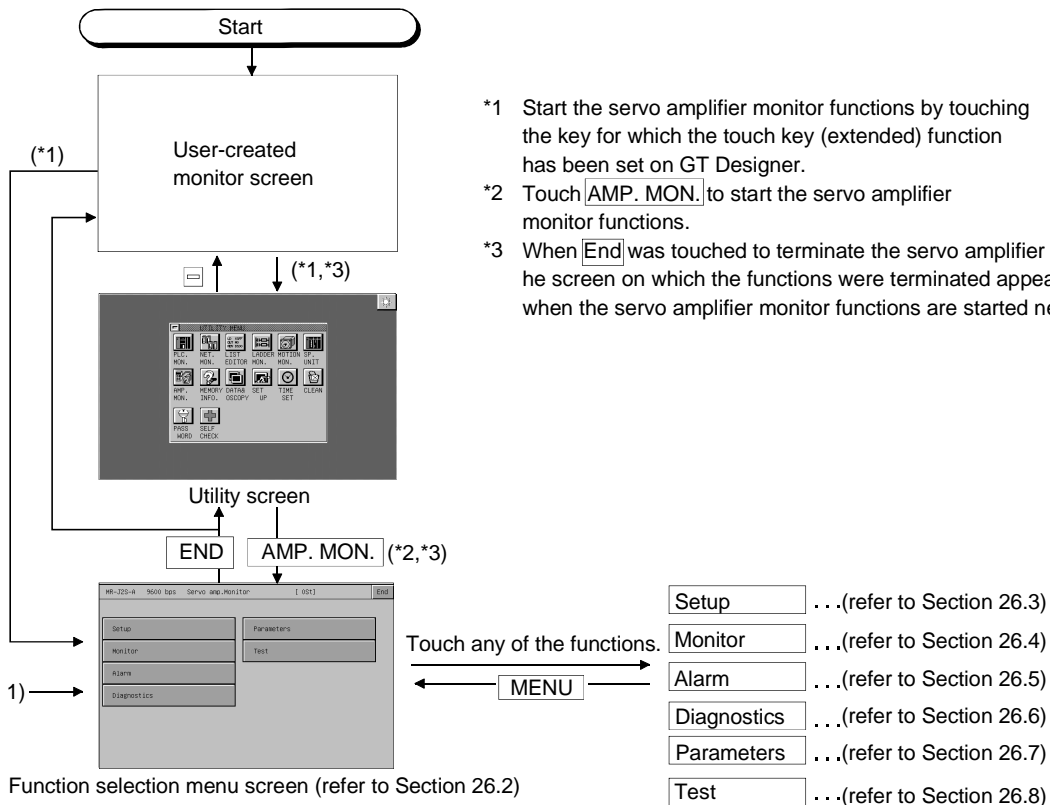

- *1 Start the servo amplifier monitor functions by touching the key for which the touch key (extended) function has been set on GT Designer.
- *2 Touch [AMP. MON.] to start the servo amplifier monitor functions.
- *3 When [End] was touched to terminate the servo amplifier monitor functions, the screen on which the functions were terminated appears when the servo amplifier monitor functions are started next time.

26.2 About the Servo Amplifier Monitor Functions

The servo amplifier monitor functions allow various monitor functions, parameter setting changes, test operations and others to be performed for the servo amplifier connected to the GOT.

Select and display the required function from the function selection menu screen.

(Function selection menu screen)

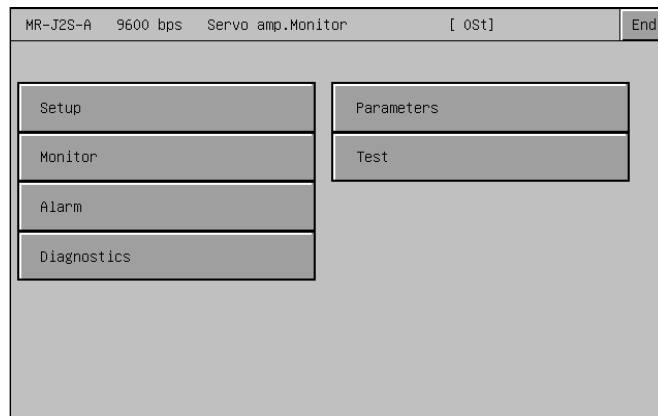

- 1) Setup..... Selects the model of the servo amplifier to be monitored by the servo amplifier function, the communication baudrate, station number setting (station number presence/absence, station number selection), and IFU station number.
(Refer to Section 26.2)
- 2) Monitor Displays all monitor data of the servo amplifier in real time.
(Refer to Section 26.3)
- 3) Alarm..... Displays the currently occurring alarm and displays the history. Also resets the alarm or clears the history.
(Refer to Section 26.4)
- 4) Diagnostics Runs the following various diagnostics on the connected servo amplifier.
(Refer to Section 26.5)
 - DI/DO display
Displays the ON/OFF states of the external I/O signals.
 - Function device display
Displays the ON/OFF states of the I/O function devices.
 - Amplifier information display
Displays the model, ID and encoder resolution of the servo motor connected to the servo amplifier.
 - ABS data display
Displays the absolute position data of the absolute position detection system.
 - Unit composition list display
Displays the servo amplifier unit composition list.
- 5) Parameters Displays the parameter data and changes the parameter setting.
(Refer to Section 26.6)
- 6) Test Performs various test operations (JOG operation, positioning operation, motorless operation, DO forced output).
(Refer to Section 26.7)

26.3 Setup

Set communication with the servo amplifier.

POINT
(1) Before making the settings on the setup screen, also make the same settings on the servo amplifier side. If the settings on this screen differ from the settings on the servo amplifier side, normal communication may not be performed.
(2) The settings on the setup screen return to the initial states when the GOT is powered off or reset. After powering on the GOT, make settings on the setup screen again.

26.3.1 Setup screen

This section explains the display data of the setup screen and the key functions displayed on the screen.

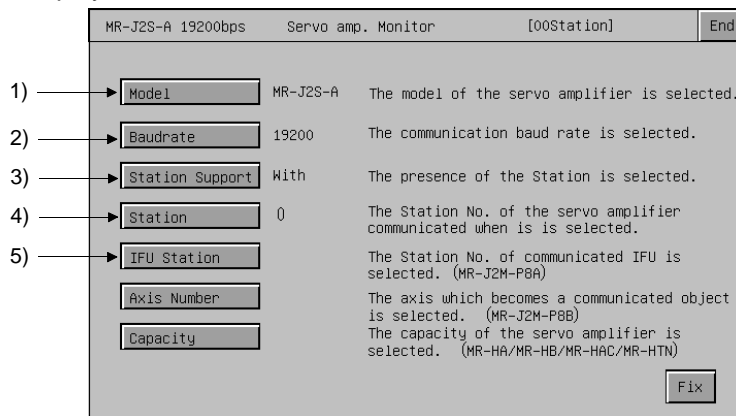

*You cannot set "Axis number" and "Capacity setting".

(1) About the display data

No.	Item	Description
1)	Model	Displays the servo amplifier model to be connected.
2)	Baudrate	Displays the communication baudrate (38400/19200/9600) with the servo amplifier.
3)	Station supp.	Displays the station number presence/absence.
4)	Station	Displays the station number (00 to 31) of the servo amplifier to communicate with.
5)	IFU Station	Displays the serial communication station number of the IFU (interface unit).

(2) About the key functions

The following table indicates the functions of the keys used for the operations of the alarm display screen.

Key	Function
Model	Sets the servo amplifier model to be connected.
Baudrate	Sets the communication baudrate (38400/19200/9600) with the servo amplifier. • Set the communication baudrate parameter on the servo amplifier side to 38400 or less.
Station Support*1	Sets the station number presence/absence.
Station	Sets the station number (00 to 31) of the servo amplifier to communicate with.
IFU Station*2	Sets the serial communication station number of the IFU (interface unit).
Fix	Confirms the settings and returns to the function selection menu screen.
End	Terminates the servo amplifier monitor functions.

*1: Valid only when the MR-J2S-□A is connected.

*2: Valid only when the MR-J2M A series is connected.

26.4 Monitor Functions

All monitor data of the servo amplifier are displayed in real time.

26.4.1 Monitor screen

This section explains the display data of the monitor screen and the key functions displayed on the screen.

(1) About the display data

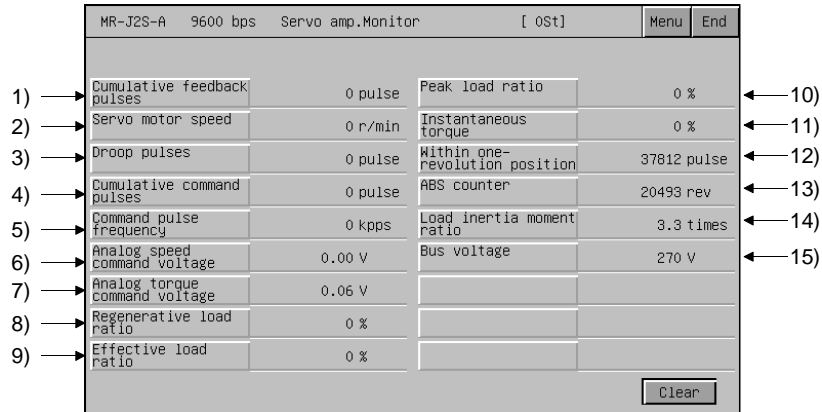





No.	Item	Description
1)	Cumulative feedback pulses	Counts and displays the feedback pulses from the servo motor encoder. • When the setting exceeds 9999999, it starts from 0. • The - sign appears for reverse rotation.
2)	Servo motor speed	Displays the servo motor speed. • The value is displayed with the 0.1r/min unit rounded off. • The - sign appears for reverse rotation.
3)	Droop pulses	Displays the droop pulses of the deviation counter. • The - sign appears for reverse rotation.
4)	Cumulative command pulses	Counts and displays the position command input pulses. • Since the value before multiplication of the electronic gear (CMX/CDV) is displayed, this value may not match the indication of the cumulative feedback pulses. • The - sign appears for the reverse rotation command.
5)	Command pulse frequency	Displays the position command input pulse frequency. • The value before multiplication of the electronic gear (CMX/CDV) is displayed. • The - sign appears for the reverse rotation command.
6)	Analog speed command voltage (In speed control mode) *1	Displays the input voltage of the analog speed command (VC).
	Analog speed limit voltage (In torque control mode) *1	Displays the input voltage of the analog speed limit (VLA).
7)	Analog torque command voltage (In position/speed control mode) *1	Displays the voltage of the analog torque limit (TLA).
	Analog torque limit voltage (In torque control mode) *1	Displays the voltage of the analog torque command (TC).

*1 Displayed only when the MR-J2S-□A is connected.

No.	Item	Description
8)	Regenerative load ratio	Displays the ratio of the regenerative power to the permissible regenerative power in % • The permissible regenerative power changes depending on the presence/absence of the regenerative brake option. Set the parameter No. 0 value correctly according to the regenerative option. (Set 80% or less as a guideline.)
9)	Effective load ratio	Displays the continuous effective load torque. • The effective value is displayed on the assumption that the rated torque is 100%.
10)	Peak load ratio	Displays the maximum torque generated. • The maximum value for the past 15 seconds is displayed on the assumption that the rated torque is 100%.
11)	Instantaneous torque	Displays the instantaneously generated torque. • The value of the generated torque is displayed in real time on the assumption that the rated torque is 100%.
12)	Within one-revolution position	Displays the within one-revolution position in the servo motor in pulse units of the encoder. • When the value exceeds the maximum pulse count, it returns to 0.
13)	ABS counter	Displays the distance from the home position (0) in the absolute position detection system as the multi-revolution counter value of the absolute position encoder.
14)	Load inertia moment ratio	Displays the estimated ratio of the servo motor shaft-equivalent load inertia moment to the servo motor's inertia moment.
15)	Bus voltage	Displays the voltage (across P - N) of the main circuit converter.

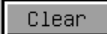
(2) About the key functions

The following table indicates the functions of the keys used for the operations of the monitor screen.

Key	Function
	Clears the "cumulative feedback pulses" or "cumulative command pulses" to 0.
	Returns to the function selection menu screen.
	Terminates the servo amplifier monitor functions.
	Scrolls the monitor items in units of six items. (Displayed only when the A95*GOT/A956WGOT is used.)

26.5 Alarm Function

The following alarm definitions are displayed.

- Alarm display: Displays the currently occurring alarm.
(Refer to Section 26.5.1.)
- Alarm history: Displays the history of alarms that occurred.
(Refer to Section 26.5.2.)

The following shows the screen transition after selection of **Alarm** on the function selection menu screen.

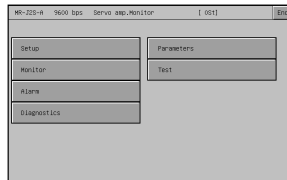

Function selection menu screen (refer to Section 26.2)

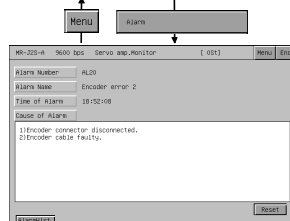

Alarm display screen

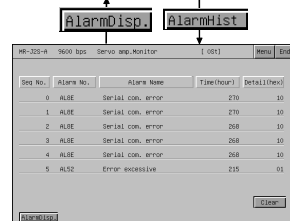

Alarm history screen

POINT

If the alarm display screen data has not been downloaded to the GOT, "Monitor data not found" appears and the subsequent screen is not displayed.

26.5.1 Alarm display screen

This section describes the display data of the alarm display screen and the key functions displayed on the screen.

(1) About the display data

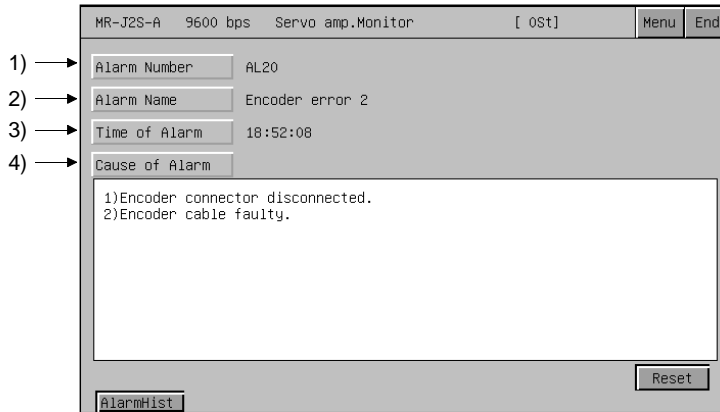

No.	Item	Description
1)	Alarm Number	Displays the number of the alarm that occurred.
2)	Alarm Name	Displays the name of the alarm that occurred.
3)	Time of Alarm	Displays the date and time when the alarm occurred. <ul style="list-style-type: none"> • The alarm occurrence time is displayed on the basis of the clock data of the PLC CPU connected to the GOT. • If a fault occurred in the servo amplifier before it is connected to the GOT, an alarm is displayed when the servo amplifier is connected to the GOT. In that case, the time when the GOT and servo amplifier was connected is displayed as the alarm occurrence time.
4)	Cause of Alarm	Displays the cause of the currently occurring alarm.

(2) About the key functions

The following table indicates the functions of the keys used for the operations of the alarm display screen.

Key	Function
	Resets the alarm. <ul style="list-style-type: none"> • Sets the servo amplifier model to be connected.
	Displays the cause of the alarm on the window screen. (Displayed only when the A95*GOT/A956WGOT is used.)
	Changes to the alarm history screen (refer to Section 26.5.2).
	Confirms the settings and returns to the function selection menu screen.
	Terminates the servo amplifier monitor functions.

26.5.2 Alarm history screen

This section describes the display data of the alarm history screen and the key functions displayed on the screen.

(1) About the display data

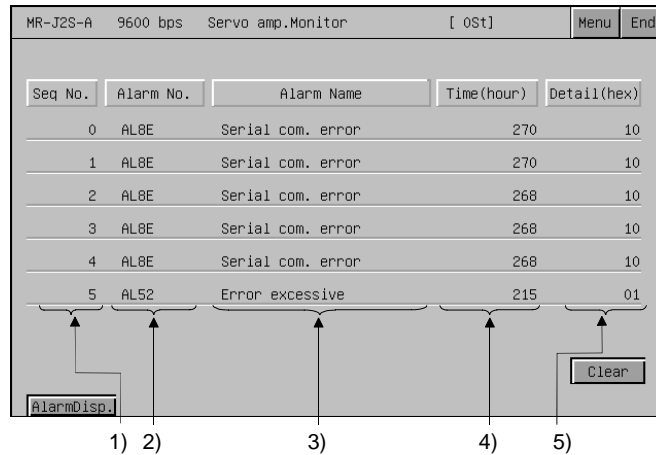

No.	Item	Description
1)	Sequence No.	Displays the alarm history, starting from the newest alarm, in order. • The newer alarms have smaller history numbers. (0 is the newest.) • Six alarms are displayed.
2)	Alarm No.	Displays the number of the alarm that occurred
3)	Alarm Name	Displays the name of the alarm that occurred. (Displayed only when the A95*GOT/A956WGOT is used.)
4)	Time (hour)	Displays the energization time of the servo amplifier until alarm occurrence on the assumption that the time at shipment from the factory is "0".
5)	Detail (hex)	Displays the code of the alarm detail information.

(2) About the key functions

The following table indicates the functions of the keys used for the operations of the alarm history screen.

Key	Function
	Clears the alarm history stored in the servo amplifier.
	Changes to the alarm display screen (refer to Section 26.5.1).
	Confirms the settings and returns to the function selection menu screen.
	Terminates the servo amplifier monitor functions.

26.6 Diagnostics Function

Run the following various diagnostics on the connected servo amplifier.

- DI/DO display : Displays the ON/OFF states of the external I/O signals.
(Refer to Section 26.6.1)
- Function device display : Displays the ON/OFF states of the I/O function devices.
(Refer to Section 26.6.2)
- Amplifier information display : Displays the model, ID and encoder resolution of the
(Refer to Section 26.6.3) servo motor connected to the servo amplifier.
- ABS data display : Displays the absolute position data of the absolute
(Refer to Section 26.6.4) position detection system.
- Unit composition list display : Displays the servo amplifier unit composition list.
(Refer to Section 26.6.5)

(1) Screen transition

The following shows the screen transition after selection of **Diagnostics** on the function selection menu screen.

Some screens may not be displayed depending on the model of the connected servo amplifier.

For the screens that cannot be displayed, refer to (2).

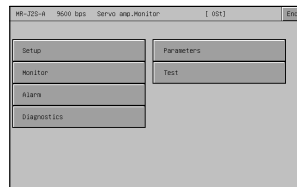

Function selection menu screen (refer to Section 26.2)

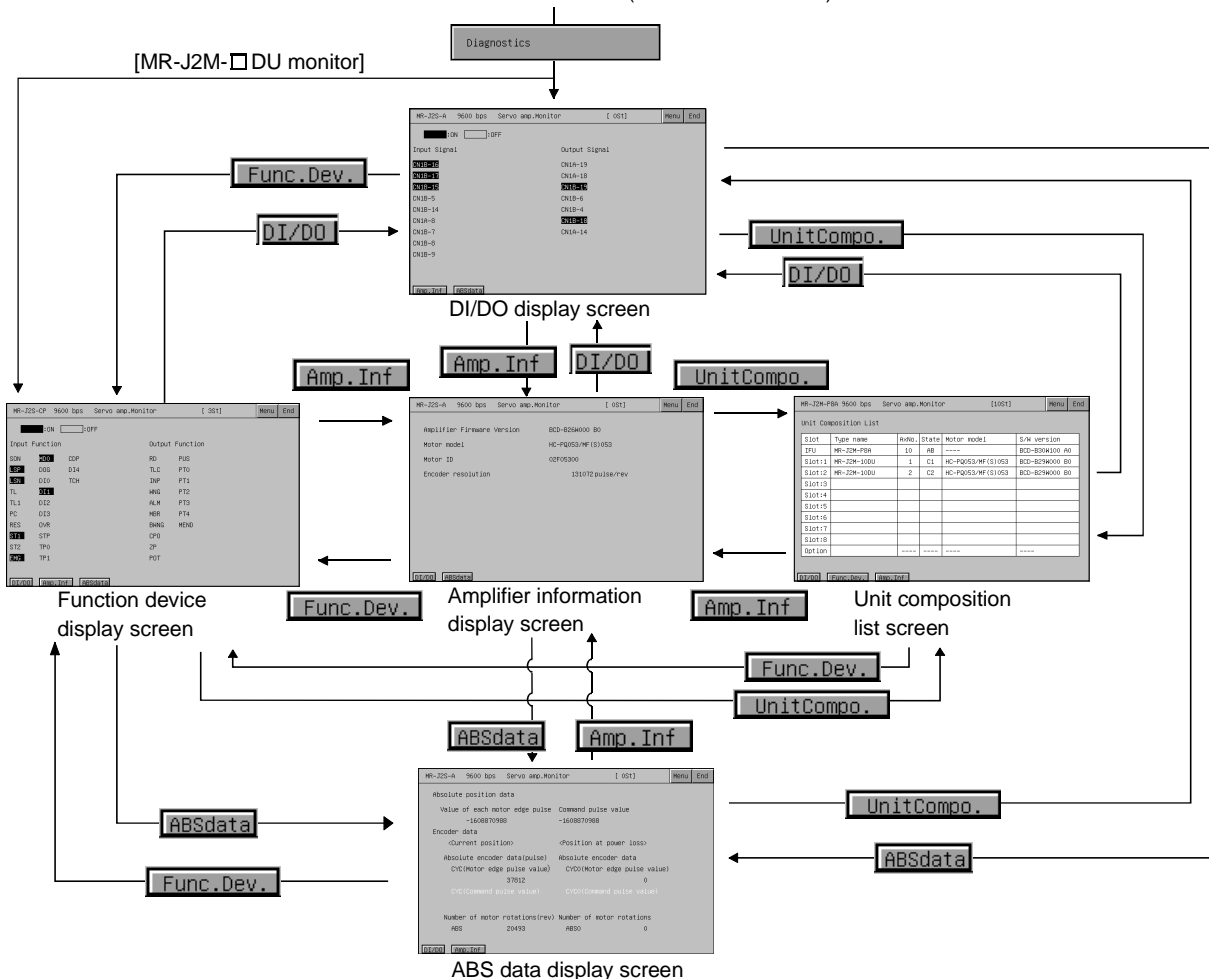

POINT
If the DI/DO display screen data or function device display screen (for MR-J2M□DU monitor only) data has not been downloaded to the GOT, "Monitor data not found" appears and the subsequent screens are not displayed.

(2) Display screens

The screens that can be displayed are indicated on a servo amplifier model basis.

Display Screen \ Servo Amplifier	MR-J2S-□A	MR-J2S-□CP	MR-J2M A Series	
			MR-J2M-P8A	MR-J2M-□DU
DI/DO display screen	○	○	○	—
Function device display screen	—	○	○	○
Amplifier information display screen	○	○	—	○
ABS data display screen	○	○	—	○
Unit composition list display screen	—	—	○	○

○: Screen present —: Screen absent

26.6.1 DI/DO display screen

This section describes the display data of the DI/DO display screen and the key functions displayed on the screen.

(1) About the display data

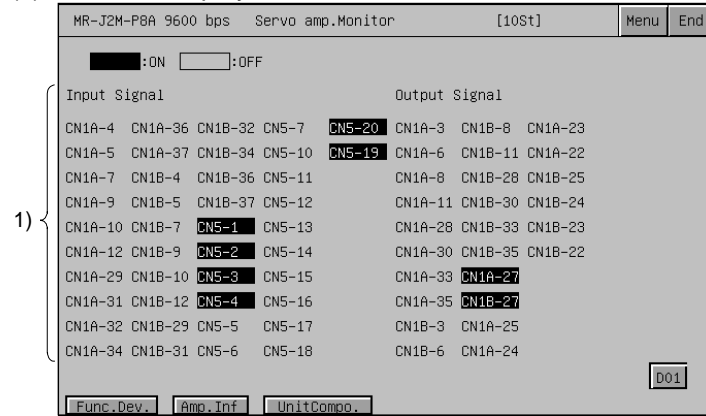

No.	Item	Description
1)	Input/Output Signal	Indicates the ON (lit)/OFF (extinguished) of the DI/DO signal.

(2) About the key functions

The following table indicates the functions of the keys used for the operations of the DI/DO display screen.

Key	Function
*1	Displays the DI/DO signals of the extension IO unit.
	Changes to the function device screen (refer to Section 26.6.2).
	Changes to the amplifier information screen (refer to Section 26.6.3).
	Changes to the unit composition list screen (refer to Section 26.6.5).
	Changes to the ABS data screen (refer to Section 26.6.4).
	Confirms the settings and returns to the function selection menu screen.
	Terminates the servo amplifier monitor functions.

*1: Displayed only when the MR-J2M A series is connected.

26.6.2 Function device display screen

This section describes the display data of the function device display screen and the key functions displayed on the screen.

(1) About the display data

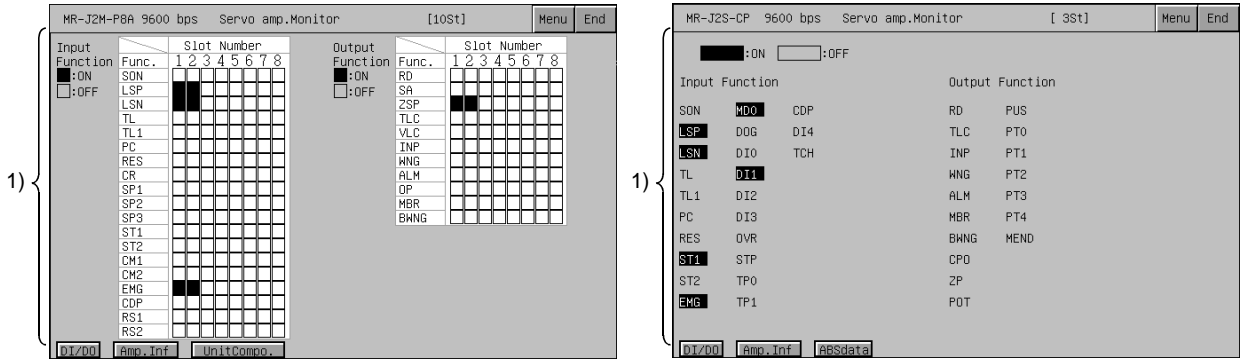

[When MR-J2S-□CP is monitored]

No.	Item	Description
1)	Input/Output Function	Indicates the ON (■)/OFF (□) state of each I/O signal.

(2) About the key functions

The following table indicates the functions of the keys used for the operations of the function device display screen.

Key	Function
In-Func.	Changes the indication of the I/O signal. (Displayed only when the A95*GOT/A956WGOT is used.)
DI/DO	Changes to the DI/DO display screen (refer to Section 26.6.1).
ABSdata	Changes to the ABS data screen (refer to Section 26.6.4).
Amp. Inf	Changes to the amplifier information screen (refer to Section 26.6.3).
UnitCompo.	Changes to the unit composition list screen (refer to Section 26.6.5).
Menu	Confirms the settings and returns to the function selection menu screen
End	Terminates the servo amplifier monitor functions
▲ ▼	Scrolls the I/O signal items in units of 10 items. (Displayed only when the A95*GOT/A956WGOT is used.)

26.6.3 Amplifier information display screen

This section describes the display data of the amplifier information display screen and the key functions displayed on the screen.

(1) About the display data

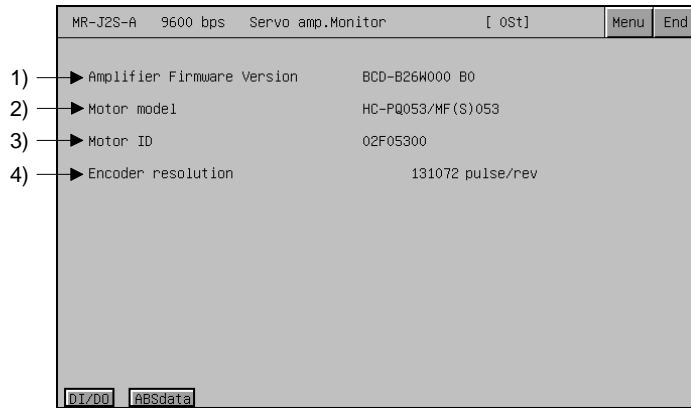

No.	Item	Description
1)	Amplifier Firmware Version ^{*1}	Displays the software number of the servo amplifier connected to the GOT.
2)	Motor model ^{*1}	Displays the model of the servo motor connected to the servo amplifier.
3)	Motor ID ^{*1}	Displays the ID of the servo motor connected to the servo amplifier.
4)	Encoder resolution ^{*1}	Displays the encoder resolution of the servo motor connected to the servo amplifier.

*1 Not displayed for MR-J2M-P8A monitor.

(2) About the key functions

The following table indicates the functions of the keys used for the operations of the amplifier information display screen.

Key	Function
	Changes to the DI/DO display screen (refer to Section 26.6.1).
	Changes to the function device screen (refer to Section 26.6.2).
	Changes to the ABS data screen (refer to Section 26.6.4).
	Changes to the unit composition list screen (refer to Section 26.6.5).
	Confirms the settings and returns to the function selection menu screen.
	Terminates the servo amplifier monitor functions.

26.6.4 ABS data display screen

This section describes the display data of the ABS data display screen and the key functions displayed on the screen.

(1) About the display data

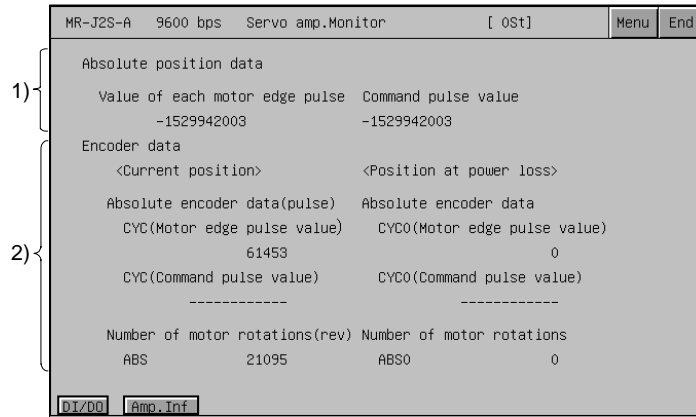

No.	Item	Description
1)	Absolute position data	Displays the following items of the absolute position data in the absolute position detection system. <ul style="list-style-type: none"> • Motor edge pulse value • Command pulse value
2)	Encoder data	Displays the following items of the encoder data. <p><Current position></p> <ul style="list-style-type: none"> • Absolute encoder data • CYC (Motor edge pulse value) • CYC (Command pulse value) • Number of motor rotations ABS <p><Position at power loss></p> <ul style="list-style-type: none"> • Absolute encoder data • CYC0 (Motor edge pulse value) • CYC0 (Command pulse value) • Number of motor rotations ABS0

(2) About the key functions

The following table indicates the functions of the keys used for the operations of the ABS data display screen.

Key	Function
Current position	Changes the indication between the current value and home position information of the encoder data. (Displayed only when the A95*GOT/A956WGOT is used.)
DI/DO	Changes to the DI/DO display screen (refer to Section 26.6.1).
Func.Dev.	Changes to the function device screen (refer to Section 26.6.2).
UnitCompo.	Changes to the unit composition list screen (refer to Section 26.6.5).
Amp. Inf	Changes to the amplifier information screen (refer to Section 26.6.3).
Menu	Confirms the settings and returns to the function selection menu screen.
End	Terminates the servo amplifier monitor functions.

26.6.5 Unit composition list display screen

This section describes the display data of the unit composition list display screen and the key functions displayed on the screen.

(1) About the display data

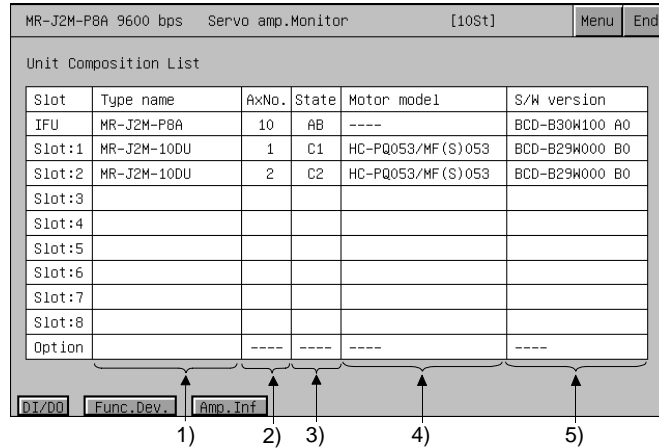

No.	Item	Description
1)	Type name	Displays the types of the drive unit (DRU), interface unit (IFU) and option unit installed to the slots.
2)	Axis No.	Displays the axis numbers of the drive unit (DRU) and interface unit (IFU).
3)	State	Displays the states and alarm/warning numbers of the drive unit (DRU) and interface unit (IFU).
4)	Motor model	Displays the motor model connected to the drive unit (DRU).
5)	S/W version	Displays the software numbers of the drive unit (DRU) and interface unit (IFU).

(2) About the key functions

The following table indicates the functions of the keys used for the operations of the unit composition list display screen.

Key	Function
	Changes to the DI/DO display screen (refer to Section 26.6.1).
	Changes to the ABS data screen (refer to Section 26.6.4).
	Changes to the amplifier information screen (refer to Section 26.6.3).
	Changes to the function device screen (refer to Section 26.6.2).
	Confirms the settings and returns to the function selection menu screen.
	Terminates the servo amplifier monitor functions.
	Scrolls the list display in units of three items. (Displayed only when the A95*GOT/A956WGOT is used.)

26.7 Parameter Setting

Using the parameter setting function, you can set the servo parameters (basic parameters/extension parameters 1, 2) for the connected servo amplifier. After the password has been set on GT Designer, an attempt to access the parameter setting screen of the servo amplifier monitor displays the password input screen. After selection of **Parameters** on the function selection menu screen, the screen transition is as shown below.

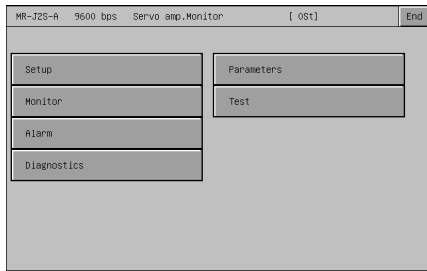

Function selection menu screen (refer to Section 26.2)

*1 Set the servo parameter changing password on GT Designer. For details of the parameter setting, refer to the GT Works Version 5/GT Designer Version 5 Reference Manual.

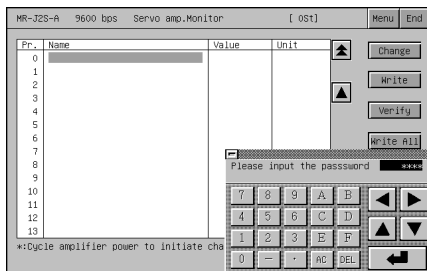
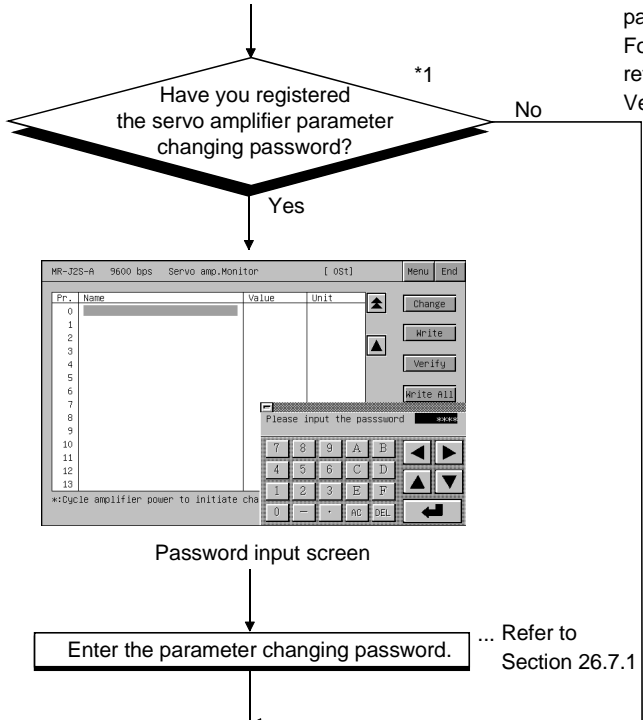

Password input screen

Enter the parameter changing password. ... Refer to Section 26.7.1

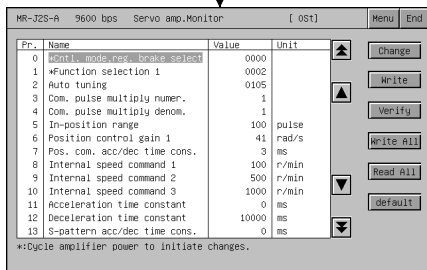



Parameter setting screen

26.7.1 Password entry operation procedure

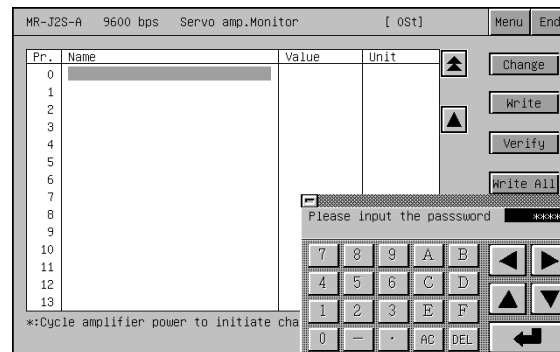
The following gives the servo parameter changing password input operation procedure.









(1) Features

- If the characters entered match a password, the Parameter Setting screen appears.
- If the password does not match, the error message appears.
Touching  returns to the function selection menu screen.
- Numerical numbers and alphabets  to  can be used for a password.

(2) Procedure

(a) To enter a password, follow these steps:

- Touch  to  and  to  to enter a password.
- Touch  to confirm the password entered.
- To correct the password entered, touch  to delete wrong characters and then enter correct characters again.

(b) To quit entering a password:

- Touch  to return to the previous monitor screen.

26.7.2 Parameter setting screen

This section describes the display data of the parameter setting screen and the key functions displayed on the screen.

POINT

The * mark preceding the parameter name indicates that the parameter is made valid when power is switched off once and then on again after the parameter value has been set.

(1) Display screen

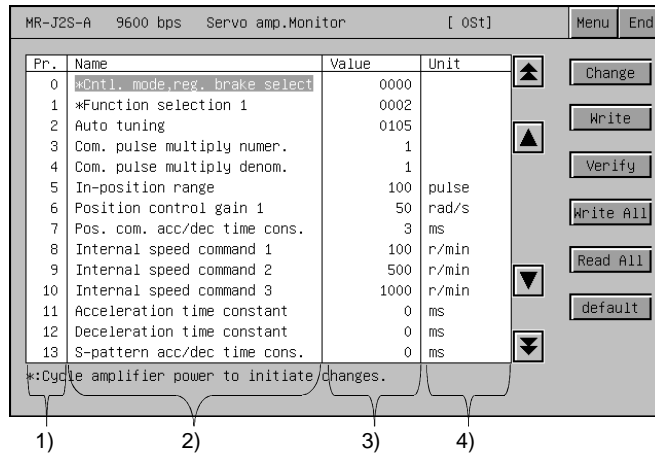

No.	Item	Description
1)	Pr. ^{*1}	Displays the parameter number.
2)	Name	Displays the parameter name.
3)	Value ^{*1}	Displays the current setting of the parameter.
4)	Unit ^{*1}	Displays the setting unit of each parameter.

*1: When the A956W/A95*GOT is used, the information of only the selected parameter is displayed at the bottom of the screen.

(2) About the key functions

The following table indicates the functions of the keys used for the operations of the parameter setting screen.

Key	Function
	Selects the servo parameter setting item.
	Scrolls the parameter items in units of one screen.
	Changes the servo parameter setting read to the GOT internal memory.
	Writes the servo parameter setting of the selected item to the servo amplifier.
	Verifies all parameter values currently displayed on the GOT and the parameter values of the servo amplifier.
	Writes all parameter values currently displayed on the GOT to the parameters of the servo amplifier.
	Reads all parameter values from the servo amplifier to the GOT and displays them there.
	Returns all parameter values to the initial values.

Key	Function
<div style="border: 1px solid black; padding: 2px; display: inline-block;">Param. IFU</div> <div style="border: 1px solid black; padding: 2px; display: inline-block;">Param. DRU^{*1}</div>	Every time touched, changes the parameter display between the drive unit (DRU) and interface unit (IFU).
<div style="border: 1px solid black; padding: 2px; display: inline-block;">Slot:1^{*1}</div>	Selects the slot number of the drive unit (DRU).
<div style="border: 1px solid black; padding: 2px; display: inline-block;">Pr. 0^{*1}</div>	Displays the specified parameter number on the parameter list screen. (Displayed only when the A95*GOT/A956WGOT is used.)
<div style="border: 1px solid black; padding: 2px; display: inline-block;">Menu</div>	Confirms the settings and returns to the function selection menu screen.
<div style="border: 1px solid black; padding: 2px; display: inline-block;">End</div>	Terminates the servo amplifier monitor functions.

*1: Displayed only when the MR-J2M A series is connected.

26.7.3 Parameter setting operation

The following describes the procedure of changing the setting of the "Auto tuning" item as an example of parameter setting operation .

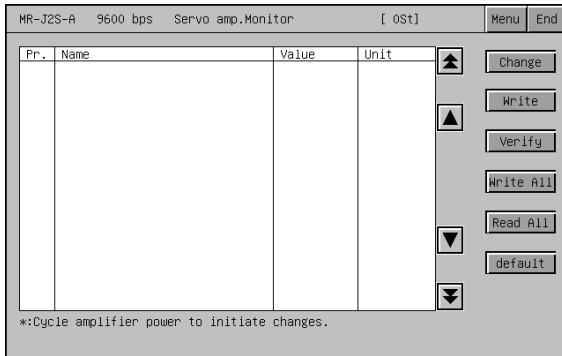

1) Touch the **Read All** key.

The parameter values in the servo amplifier are read and displayed on the screen.

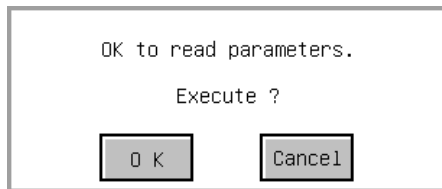

2) The parameter read confirmation window appears.

Touch the **OK** key to read the parameter values in the servo amplifier to the GOT.

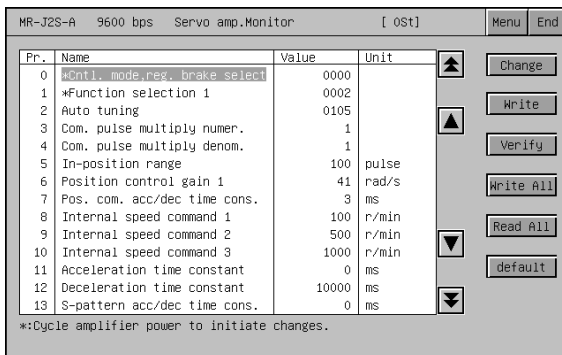

3) The parameter values read from the servo amplifier are displayed on the screen.

The parameters disabled for write/read are not displayed on the parameter setting screen.

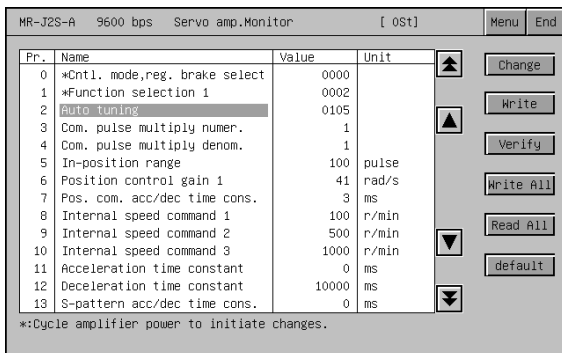

4) Choose the item whose parameter will be set with the **▲**, **▼** key, and touch the **Change** key.

↓
(To next page)

(From previous page)

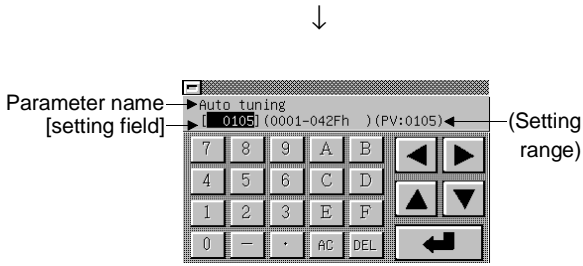

- 5) As the parameter setting window appears, enter the parameter setting data with **Alphanumeric**, and touch **Enter** to confirm the setting. If you do not confirm it, touch **Close** to close the parameter setting window.

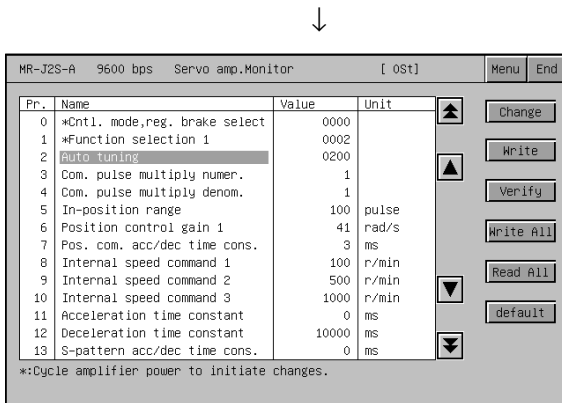

- 6) The parameter value changes on the parameter setting screen.

Choose the changed parameter item and touch the **Write** key. When you have changed the settings of two or more parameter items, touch the **Write All** key to write all the parameter items whose settings have been changed.

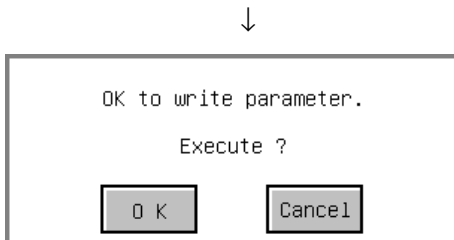

- 7) The confirmation window appears. Touch the **OK** key to write the parameter setting to the servo amplifier. When you do not write the parameter setting, touch the **Cancel** key.

This completes the parameter setting write operation.

POINT

- (1) The changes made to the parameter settings are written to the E²PROM of the servo amplifier. Hence, if the amplifier is powered off, the written parameter values are retained.
- (2) When you have changed any parameter setting on the servo amplifier side, also change that setting to the same value on the setup screen of the GOT (Section 26.2). If the setup screen settings and servo amplifier side settings do not match, normal communication cannot be made with the servo amplifier.
 - Serial communication baudrate selection
 - Protocol station number selection
 - Station number setting

26.8 Test Operations

The following test operations are performed for the connected servo amplifier.

- JOG operation : The servo motor runs while you are touching the Forward or Reverse key.
(Refer to Section 26.8.3.)
- Positioning operation : When you touch the Forward or Reverse key, this operation starts and runs the servo motor by the preset distance.
(Refer to Section 26.8.4.)
- Motorless operation : Simulates the operation of the servo motor in the servo amplifier if the servo motor is not connected.
(Refer to Section 26.8.5.)
- DO forced output : Forcibly turns ON/OFF the output signals independently of the output conditions of the servo amplifier output signals.
(Refer to Section 26.8.6.)

(1) The following shows the screen transition after selection of **Test** on the function selection menu screen.

Some screens may not be displayed depending on the model of the connected servo amplifier.

For the screens that cannot be displayed, refer to (2).

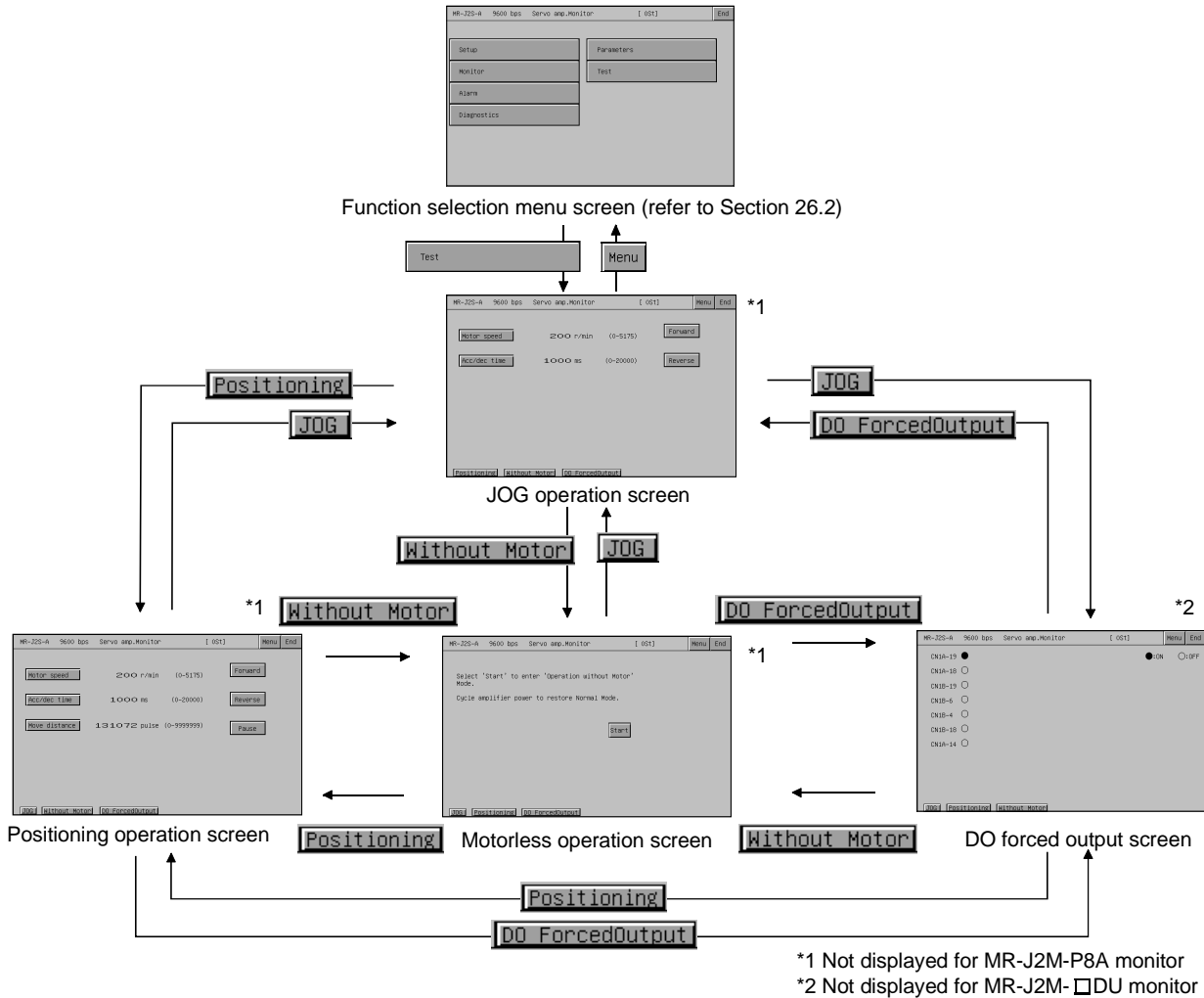

POINT

If the JOG operation screen data has not been downloaded to the GOT, "Monitor data not found" appears and the subsequent screens are not displayed.

(2) Display screens

The screens that can be displayed are indicated on a servo amplifier model basis.

Display Screen \ Servo Amplifier	MR-J2S-□ A	MR-J2S-□ CP	MR-J2M A Series	
			MR-J2M-P8A	MR-J2M-□DU
JOG operation	○	○	—	○
Motorless operation	○	○	—	○
Positioning operation screen	○	○	—	○
DO forced output screen	○	○	○	—

○: Screen present —: Screen absent

26.8.1 Precautions for test operations

This section gives the precautions for using the test operations of the servo amplifier monitor functions.

**WARNING**

- Do not operate the servo amplifier switches with wet hands. Doing so can cause an electric shock.
- Do not perform operations with the front cover of the servo amplifier removed. Doing so can cause an electric shock since the high-voltage terminals and charging section are exposed.
- Do not open the front cover of the servo amplifier while power is on and during operation. Doing so can cause an electric shock.

**CAUTION**

- Before starting test operations, always read the precautions for test operations in the manual of the corresponding servo amplifier.
- Before starting operation, check the servo amplifier parameters. Depending on the machine, unexpected operation may be performed.
- While power is on or for some time after power-off, the servo amplifier's heat sink and regenerative brake resistor, the servo motor, and others may be hot. Do not touch them and bring the parts (cables, etc.) close to them. Doing so can cause a burn and damage to the parts.

(1) Servo on

In the JOG operation and positioning operation among the test operations, the SON digital input signal of the servo amplifier is turned ON automatically in the servo amplifier to start operation, independently of whether the SON signal is ON or OFF.

The servo amplifier does not accept any external command pulses and input signals (except the emergency stop) until the test operation screen is closed. SON turns ON automatically by touching the **Forward** or **Reverse** key on the JOG operation screen or positioning operation screen.

(2) Stop

POINT

To make an emergency stop, turn OFF the emergency stop signal of the servo amplifier or switch off the input power.

- (a) The operation for stopping the test operation on the servo amplifier monitor screen is as described below.
- JOG operation: Release the **Forward** or **Reverse** key.
 - Positioning operation: Touch the **Pause** key.
- (b) The servo motor stops if any of the following states occurs during test operation.
- The communication cable is disconnected.
 - The servo amplifier monitor screen is switched to that of the other servo amplifier, or the servo amplifier monitor function is terminated.
- However, during motorless operation, the test mode is not canceled until the servo amplifier is powered off.

26.8.2 Preparations for test operations

To start test operations, you need to make settings for test operations on the connected servo amplifier.

For details of the servo amplifier side settings for performing test operations, refer to the manual of the connected servo amplifier.

26.8.3 JOG operation screen

This section describes the display data of the JOG operation screen and the key functions displayed on the screen.

(1) About the display data

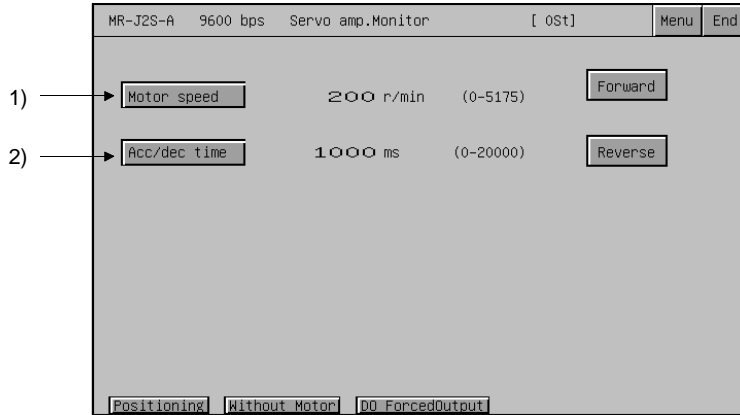

No.	Item	Description
1)	Motor speed	Displays the set speed of the servo motor.
2)	Acc/dec time	Displays the set acceleration/deceleration time constant of the servo motor.

(2) Operation

- Operation start
Touch the **Forward** or **Reverse** key.
- Operation stop
Release the **Forward** or **Reverse** key.

(3) About the key functions

The following table indicates the functions of the keys used for the operations of the JOG operation screen.

Key	Function
Forward	Runs the servo motor in the forward rotation (CCW) direction while being touched.
Reverse	Runs the servo motor in the reverse rotation (CW) direction while being touched.
Motor speed	Changes the servo motor speed.
Acc/dec time	Changes the acceleration/deceleration time constant.
Positioning	Changes to the positioning operation screen (refer to Section 26.8.4).
Without Motor	Changes to the motorless operation screen (refer to Section 26.8.5).
DO ForcedOutput	Changes to the DO forced output screen (refer to Section 26.8.6).
Menu	Confirms the settings and returns to the function selection menu screen.
End	Terminates the servo amplifier monitor functions.

26.8.4 Positioning operation screen

This section describes the display data of the positioning operation screen and the key functions displayed on the screen.

(1) About the display data

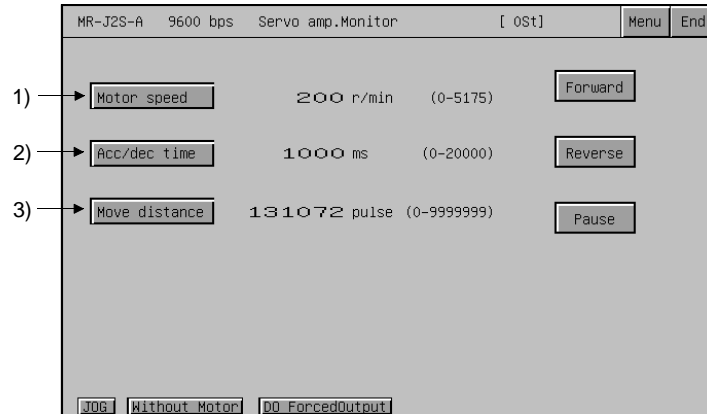

No.	Item	Description
1)	Motor speed	Displays the set speed of the servo motor.
2)	Acc/dec time	Displays the set acceleration/deceleration time constant.
3)	Move distance	Displays the set distance.

(2) Operation

- Operation start
Touch the **Forward** or **Reverse** key.
To resume the operation stopped temporarily, retouch the **Forward** button for forward rotation or the or **Reverse** button for reverse rotation.
- Operation stop
Operation stops when the axis has moved the preset distance.
Alternatively, touch the **Pause** key to stop the operation temporarily.
After a temporary stop, retouch the **Pause** key to erase the remaining distance.

(3) About the key functions

The following table indicates the functions of the keys used for the operations of the positioning operation screen.

Key	Function
Forward	Runs the servo motor in the forward rotation (CCW) direction.
Reverse	Runs the servo motor in the reverse rotation (CW) direction.
Pause	Stops the running servo motor temporarily.
Motor speed	Changes the servo motor speed.
Acc/dec time	Changes the acceleration/deceleration time constant.
Move distance	Changes the distance.
JOG	Changes to the JOG operation screen (refer to Section 26.8.3).
Without Motor	Changes to the motorless operation screen (refer to Section 26.8.5).
DO ForcedOutput	Changes to the DO forced output screen (refer to Section 26.8.6).
Menu	Confirms the settings and returns to the function selection menu screen.
End	Terminates the servo amplifier monitor functions.

26.8.5 Motorless operation screen

This section describes the display data of the motorless operation screen and the key functions displayed on the screen.

(1) About the display data

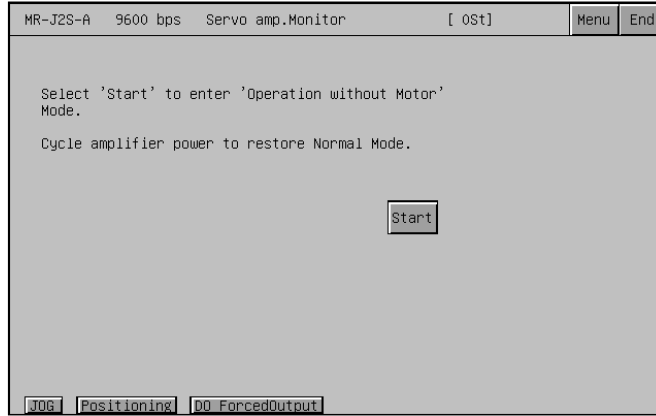

(2) Operation

- Operation start
Touch the **Start** key.
- Operation stop
Power off the servo amplifier to cancel the motorless operation.

(3) About the key functions

The following table indicates the functions of the keys used for the operations of the motorless operation screen.

Key	Function
Start	Starts motorless operation.
JOG	Changes to the JOG operation screen (refer to Section 26.8.3).
Positioning	Changes to the positioning operation screen (refer to Section 26.8.4).
DO ForcedOutput	Changes to the DO forced output screen (refer to Section 26.8.6).
Menu	Confirms the settings and returns to the function selection menu screen.
End	Terminates the servo amplifier monitor functions.

26.8.6 DO forced output screen

This section describes the display data of the DO forced output screen and the key functions displayed on the screen.

(1) About the display data

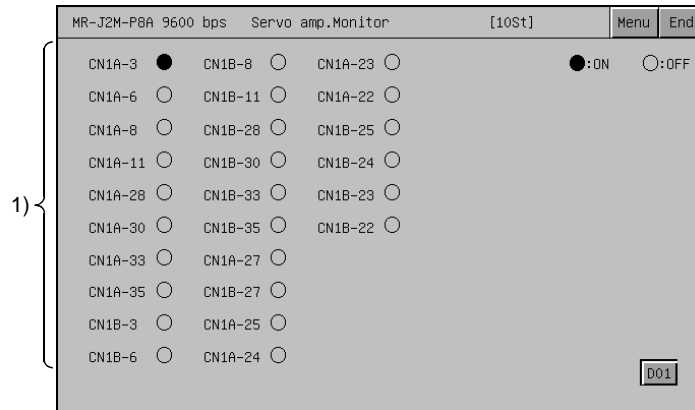

No.	Item	Description
1)	Output signal ON/OFF state	Displays the ON (●)/OFF (○) of each output signal of the servo amplifier. • After this screen has been switched to another screen, all external I/O signals are turned OFF

(2) Operation

Touch the required output signal name to invert the ON/OFF status of the corresponding signal and write it to the servo amplifier.

(3) About the key functions

The following table indicates the functions of the keys used for the operations of the DO forced output screen.

Key	Function
CN1A-3 (Signal names of output signals)	By touching the signal name of the required output signal, SET/RESET the corresponding signal status (● : ON, ○ : OFF). • If the current output signal is ON, it is turned OFF (reset). If it is OFF, it is turned ON (set).
D01 *1	Displays the external output signals of the extension I/O unit.
JOG	Changes to the JOG operation screen (refer to Section 26.8.3)
Positioning	Changes to the positioning operation screen (refer to Section 26.8.4).
Without Motor	Changes to the motorless operation screen (refer to Section 26.8.5).
Menu	Confirms the settings and returns to the function selection menu screen.
End	Terminates the servo amplifier monitor functions.

*1 Displayed only when the MR-J2M-P8A is connected.

26.9 About Hardcopy Output

This section describes the way to print the ladder monitor screen with the printer or to save it in the PC card in the BMP/JPEG file format during ladder monitor.

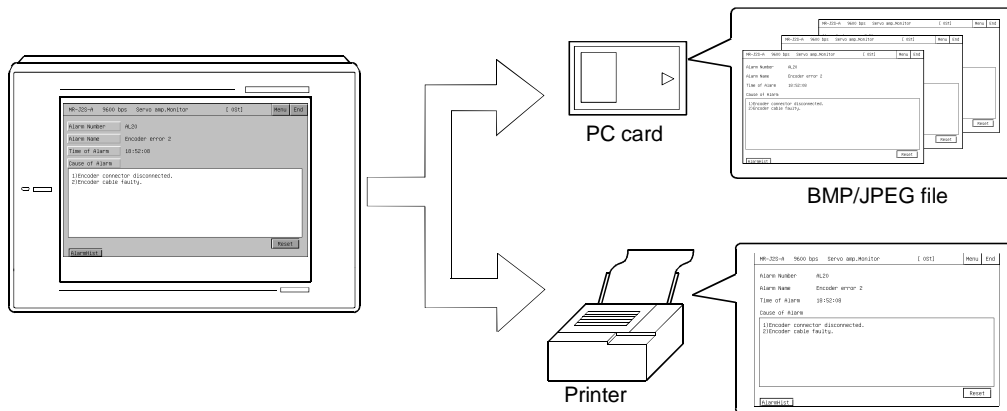

Depending on the used GOT, output the hardcopy in the following corresponding method.

(1) When A985GOT or A97*GOT is used

Touch the **Start hardcopy** or **Stop hardcopy** key displayed on the ladder monitor screen to output the hardcopy.

(2) When A95*GOT or A956WGOT is used

Set the start/stop triggering device of the hardcopy function on GT Designer and turn that device ON/OFF to output the hardcopy.

POINT

- When printing out the ladder monitor screen, always install the option driver into the GOT.
- Set the output destination (PC card/printer) of the hardcopy in the hardcopy setting of GT Designer.
Refer to Help of GT Designer for details of the hardcopy setting.

Chapter27 ERROR INDICATIONS AND CORRECTIVE ACTIONS FOR SERVO
AMPLIFIER MONITOR

This chapter provides the error indications given during servo amplifier monitor operation and their corrective actions.

Error Message	Error Definition	Corrective Action
Monitor data not found	Monitor data have not been installed, or monitor data have been deleted.	Download the monitor data of the servo amplifier monitor.
No AMP Communications	Communication cannot be made with the servo amplifier set as the monitor destination.	<ul style="list-style-type: none"> • Check the connection state (connector disconnection, cable wire break) of the servo amplifier and GOT. • Check the servo amplifier for error occurrence. • Set the same values to the servo amplifier monitor function setup screen and servo amplifier side parameters.
This test mode cannot be selected. Operation without Motor rotation	The other test operation function has started.	End the other test operation function.
SON Make sure that operation is at a stop.	The SON signal of the servo amplifier is ON.	Turn OFF the SON signal of the servo amplifier.
Servo alarm has occurred. Alarm: * *	A value outside the setting range was set in the servo parameter setting.	Set the servo amplifier parameter values inside the setting ranges.
Emergency is stopping	An alarm occurred in the connected servo amplifier.	Reset the alarm of the servo amplifier.
Unit not found	The selected slot is not loaded with the drive unit.	Select the slot where the drive unit is loaded.
Unmatched password	The password entered as the servo amplifier changing password is illegal.	Enter the correct password.
Please confirm forward or reversal stroke end (LSP or LSN)	The LSP/LSN signal of the servo amplifier is OFF.	Turn ON the LSP/LSN signal of the servo amplifier.

INDEX

- [A]
Adaptor address 4 - 8
- [B]
Baud rate 4 - 9,10
Batch monitor 9 -10
BM monitor 9 -14
Brightness/contrast
adjustment of monitor screen 4 - 3
Brightness/contrast
adjustment screen 4 -20
Buzzer sound 4 - 8
- [C]
Capacity of special module monitor data 3 - 5
Connection transmission speed 4 - 8
Clock setting 4 -16
C.C.U monitor registration 4 -10
- [D]
Deleting a registered device 9 - 9
Detailed own station monitor 17 - 3
- [E]
Entry monitor 9 - 7
Error display and handling
Ladder monitor function 7 - 1
Network monitor function 18 - 1
Special module monitor function 14 - 1
System monitor function 10 - 1
List editor function 21 - 1
Servo amplifier monitor 27 - 1
Error List 23 - 6
Error List Axis 23 - 7
- [F]
Features
Ladder monitor function 1 - 3
Network monitor function 1 - 9
Special module monitor function 1 - 7
System monitor function 1 - 5
Utility function 1 - 1
List editor function 1 -11
Servo amplifier monitor 1 -14
- Function list 2 - 4
Functions requiring a memory board 2 - 1
- [G]
Grip switch..... 4 -11
GOT IP address 4 -10
GOT PC No..... 4 -10
GOT port No..... 4 -10
GOT NET No. 4 -10
- [H]
Host (FF) address 4 - 9
How to display the utility menu 4 - 2
Human sensor detection sensitivity 4 - 9
Human sensor function 4 -11
Human sensor OFF delay 4 -11
- [L]
Ladder monitor function 1 - 3
Ladder read operation 6 - 6
List editor function..... 1 -11
- [M]
Memory capacity of OS 2 - 7
Memory information 4 -15
Message display 4 - 8
Microcomputer connection protocol 4 - 8
Microcomputer
connection transmission speed 4 - 8
- [N]
Network monitor function 1 - 9
- [O]
Operation for defect search 6 -12
Operation procedures
Ladder monitor function 5 -1
Network monitor function 15 -1
Special module monitor function 11 -1
System monitor function 8 -1
List editor function 19 -1
Servo amplifier monitor 25 - 1
Other station monitor 17 - 9
Outside speaker sound 4 - 8
Own station monitor 17 -1

[P]
 Password 4 -19
 Positioning Monitor..... 23 - 9
 Present Value Mon..... 23 - 4
 Present Value Hist..... 23 -12

[Q]
 QC24 connection transmission speed..... 4 - 9
 Quick test function 9 -19
 QBUS extension number 4 - 8
 QBUS slot number 4 - 8

[R]
 Reading data from the PLC 6 - 3
 Required equipment 2 - 1
 Reverse display..... 4 -11
 Router Address 4 -10

[S]
 Screen display and key functions
 Batch monitor 9 -11
 BM monitor 9 -15
 Detailed own station monitor 17 - 3
 Entry monitor 9 - 8
 Ladder monitor function 6 -19
 Other station monitor 17 - 9
 Special module monitor function 12 - 1
 System monitor function 9 - 1
 TC monitor 9 -13
 Screen cleanup 4 -15
 Screen & OS copy 4 - 5
 Screen save light..... 4 - 8
 Screen saver function 4 - 9
 Screen saver Human sensor 4 -11
 Screen save time 4 -8
 Servo amplifier monitor function 25 - 1
 Security password 4 -18
 Send Message Delay..... 4 - 9
 Send Message Time 4 -10
 Send Message Wait..... 4 -10
 Self test 4 -14
 Setup 4 - 7
 Servo Monitor SFC Error History..... 23 - 5
 Special module monitor function 1 - 7
 Specifications
 Ladder monitor function 3 - 1
 Network monitor function 3 - 9

Special module monitor function3 - 4
 System monitor function3 - 2
 List editor function3 -11
 Servo amplifier monitor function3 -21
 Specifying the monitor station and device ...9 - 4
 Subnet Mask4 -10
 Start up time.....4 - 9,10
 Switching the display form9 - 2
 System monitor function1 - 5

[T]
 TC monitor9 -12
 Test for special function module12 - 8
 Test function9 -16

[U]
 Utility function1 - 1
 Utility function list4 - 1

WARRANTY

Please confirm the following product warranty details before using this product.

1. Gratis Warranty Term and Gratis Warranty Range

If any faults or defects (hereinafter "Failure") found to be the responsibility of Mitsubishi occurs during use of the product within the gratis warranty term, the product shall be repaired at no cost via the sales representative or Mitsubishi Service Company.

However, if repairs are required onsite at domestic or overseas location, expenses to send an engineer will be solely at the customer's discretion. Mitsubishi shall not be held responsible for any re-commissioning, maintenance, or testing on-site that involves replacement of the failed module.

[Gratis Warranty Term]

The gratis warranty term of the product shall be for one year after the date of purchase or delivery to a designated place.

Note that after manufacture and shipment from Mitsubishi, the maximum distribution period shall be six (6) months, and the longest gratis warranty term after manufacturing shall be eighteen (18) months. The gratis warranty term of repair parts shall not exceed the gratis warranty term before repairs.

[Gratis Warranty Range]

- (1) The range shall be limited to normal use within the usage state, usage methods and usage environment, etc., which follow the conditions and precautions, etc., given in the instruction manual, user's manual and caution labels on the product.
- (2) Even within the gratis warranty term, repairs shall be charged for in the following cases.
 1. Failure occurring from inappropriate storage or handling, carelessness or negligence by the user. Failure caused by the user's hardware or software design.
 2. Failure caused by unapproved modifications, etc., to the product by the user.
 3. When the Mitsubishi product is assembled into a user's device, Failure that could have been avoided if functions or structures, judged as necessary in the legal safety measures the user's device is subject to or as necessary by industry standards, had been provided.
 4. Failure that could have been avoided if consumable parts (battery, backlight, fuse, etc.) designated in the instruction manual had been correctly serviced or replaced.
 5. Failure caused by external irresistible forces such as fires or abnormal voltages, and Failure caused by force majeure such as earthquakes, lightning, wind and water damage.
 6. Failure caused by reasons unpredictable by scientific technology standards at time of shipment from Mitsubishi.
 7. Any other failure found not to be the responsibility of Mitsubishi or that admitted not to be so by the user.

2. Onerous repair term after discontinuation of production

(1) Mitsubishi shall accept onerous product repairs for seven (7) years after production of the product is discontinued.

Discontinuation of production shall be notified with Mitsubishi Technical Bulletins, etc.

(2) Product supply (including repair parts) is not available after production is discontinued.

3. Overseas service

Overseas, repairs shall be accepted by Mitsubishi's local overseas FA Center. Note that the repair conditions at each FA Center may differ.

4. Exclusion of loss in opportunity and secondary loss from warranty liability

Regardless of the gratis warranty term, Mitsubishi shall not be liable for compensation of damages caused by any cause found not to be the responsibility of Mitsubishi, loss in opportunity, lost profits incurred to the user by Failures of Mitsubishi products, special damages and secondary damages whether foreseeable or not, compensation for accidents, and compensation for damages to products other than Mitsubishi products, replacement by the user, maintenance of on-site equipment, start-up test run and other tasks.

5. Changes in product specifications

The specifications given in the catalogs, manuals or technical documents are subject to change without prior notice.

6. Product application

- (1) In using the Mitsubishi MELSEC programmable logic controller, the usage conditions shall be that the application will not lead to a major accident even if any problem or fault should occur in the programmable logic controller device, and that backup and fail-safe functions are systematically provided outside of the device for any problem or fault.
- (2) The Mitsubishi programmable logic controller has been designed and manufactured for applications in general industries, etc. Thus, applications in which the public could be affected such as in nuclear power plants and other power plants operated by respective power companies, and applications in which a special quality assurance system is required, such as for Railway companies or Public service purposes shall be excluded from the programmable logic controller applications.

In addition, applications in which human life or property that could be greatly affected, such as in aircraft, medical applications, incineration and fuel devices, manned transportation, equipment for recreation and amusement, and safety devices, shall also be excluded from the programmable logic controller range of applications.

However, in certain cases, some applications may be possible, providing the user consults their local Mitsubishi representative outlining the special requirements of the project, and providing that all parties concerned agree to the special circumstances, solely at the users discretion.

GOT-A900 Series Operating Manual

(GT Works Version5/GT Designer Version5 compatible
Extended•Option Functions Manual)

MODEL	SW5-GOTR-O(SYS)-E
MODEL CODE	1DM185
SH(NA)-080118-J(0601)MEE	

 **MITSUBISHI ELECTRIC CORPORATION**

HEAD OFFICE : TOKYO BUILDING, 2-7-3 MARUNOUCHI, CHIYODA-KU, TOKYO 100-8310, JAPAN
NAGOYA WORKS : 1-14 , YADA-MINAMI 5-CHOME , HIGASHI-KU, NAGOYA , JAPAN

When exported from Japan, this manual does not require application to the
Ministry of Economy, Trade and Industry for service transaction permission.

Specifications subject to change without notice.